



*Güneş sisteminin beşinci ve en büyük gezegeni
Yunan mitolojisindeki Zeus'un Roma kültüründeki karşılığı
Aydınlatmanın sihirli dünyasındaki yol göstericiniz*

*The fifth and the biggest planet of the solar system
Equivalent of Greek myth Zeus in Roman culture
Your guide in the magical world of lighting*

JUPITER EN SON TEKNOLOJİSİ İLE İŞİĞİ YAŞAMA DÖNÜŞTÜRÜYOR

JUPITER, uyguladığı depo otomasyon sistemiyle, ürünlerinin sevkiyatını uluslararası standartlara sahip deposundan hızlı ve hatasız bir şekilde gerçekleştiriyor.



Büyükçekmece'de 15 bin m²'yi aşan bir alana konumlanan depo, mevkisi ve en son teknolojiye sahip yönetim sistemi ile aydınlatma alanında tüm müşterilerinin ihtiyaçlarına yanıt veriyor.

Depo Bilgilerine Her Yerden Erişim İmkanı

Türkiye genelinde dağıtım yapan JUPITER, tüm müşterilerinin taleplerini eksiksiz olarak karşılayabilecek ürün çeşidini ve stoğu deposunda bulunduruyor. Karaköy'deki deposu ile de müşterilerine yerinde ve anında hizmet veren JUPITER, uyguladığı online depo otomasyonu sayesinde operasyonları hızlı ve hatasız yönetiyor.





Dünyanın her yerinden cep telefonu aracılığı ile müşterilerin ihtiyaç duyabileceği bilgilere (stok, cari, finans, risk, vb.) online erişim imkanı veren bilgi akış sistemi, sahadan veri toplamayı hızlı ve hatasız gerçekleştirerek, müşteri taleplerinin en kısa sürede karşılanmasını sağlıyor.

Sistem Nasıl İşliyor?

Sahadan alınan sipariş bilgileri plasiyerler tarafından cep telefonu aracılığıyla kontrol operatörüne ulaştırıldıktan sonra kontrollere bağlı olarak siparişler onaylanıyor ve ardından el terminallerine gönderiliyor. Bu işlem sonunda sipariş edilen ürünler, sevkiyat için depoda hazırlanıyor, el terminalleri vasıtasıyla irsaliyesi kesilerek sevkiyatı yapılıyor.



Satış sonrası destek hizmetinin verildiği atölye ve yedek parça bölümünün de ise müşteriden gelen arızalı mallar gerekli tamiri yapıp online olarak müşteriye gönderiliyor. Gönderilen ürünler sistemden çıkarılarak siparişlerde herhangi bir hataya neden olmaması sağlanıyor. 2006 yılından bu yana online depo yönetimi ile hizmet veren JUPITER, tüm sistemiyle müşterilerinin ihtiyaçlarını eksiksiz olarak karşılamaya devam ediyor.



İÇİNDEKİLER CONTENTS

İNDEKS INDEX	6	
İÇ AYDINLATMA INDOOR LIGHTING		
DEKORATİF EV ARMATÜRLERİ DECORATIVE HOME LUMINAIRES	20	
BANYO ARMATÜRLERİ BATHROOM LUMINAIRES	36	
SIVA ÜSTÜ ARMATÜRLER SURFACE MOUNTED LUMINAIRES	41	
SIVA ALTI SPOT ARMATÜRLER RECESSED SPOTSLIGHTS	70	
SIVA ALTI DOWNLIGHT ARMATÜRLER RECESSED DOWNLIGHTS	117	
MAĞAZA ARMATÜRLERİ SHOP-LIGHTING LUMINAIRES	130	
MASA LAMBALARI TABLE LAMPS	154	
GÜL ARCHITECHTURAL GÜL ARCHITECHTURAL	156	
SİLİKON STÜDYO SILIKON STUDIO	158	
DIŞ AYDINLATMA OUTDOOR LIGHTING		
DIŞ AYDINLATMA ARMATÜRLERİ OUTDOOR LUMINAIRES	164	
KOMPONENTLER COMPONENTS	223	
TEKNİK DATALAR TECHNICAL DATA	238	



ARCHITECH
BRESCIA
157



ARCHITECH
PARMA
157



ARCHITECH
VENEZIA V3
156



ARCHITECH
VENEZIA V30
156



ARCHITECH
VENEZIA V7
156



EV002
37



EV006
37



EV008
37



EV021
38



EV022
38



EV023
38



EV029
37



EV105
28



EV116
30



EV121
29



EV211
29



EV215
31



EV304
40



EV306
31



EV308
39



EV309
31



EV313
39



EV315
39

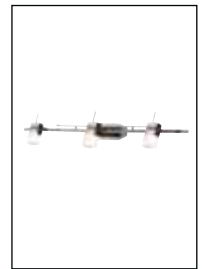

EV404
29



EV413
40

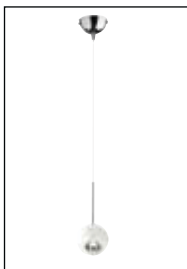

EV421
28



EV422
27

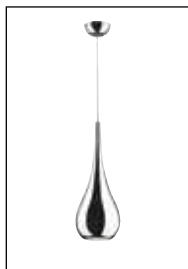

EV423
27

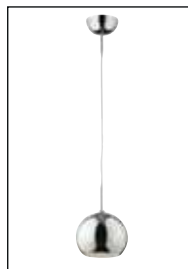

EV427
27



EV428
26

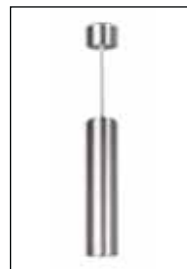

EV429
26



EV430
26



EV501
30



EV502
30



EV505
34



EV614
23



EV615
23



EV616
23



EV617
25



EV618
24



EV619 24 EV620 22 EV621 22 EV622 22 EV623 24 EV624 25 EV625 25 EV707 30



JA211 225 JC040 53 JC041 53 JC043 53 JC045 49 JC046 44 JC052 52 JC053 48



JC054 48 JC055 49 JC057 50 JC058 50 JC060 50 JC061 45 JC062 45 JC063 183



JC064 183 JC065 44 JC066 46 JC067 46 JC068 47 JC069 47 JC105 228 JC698 52

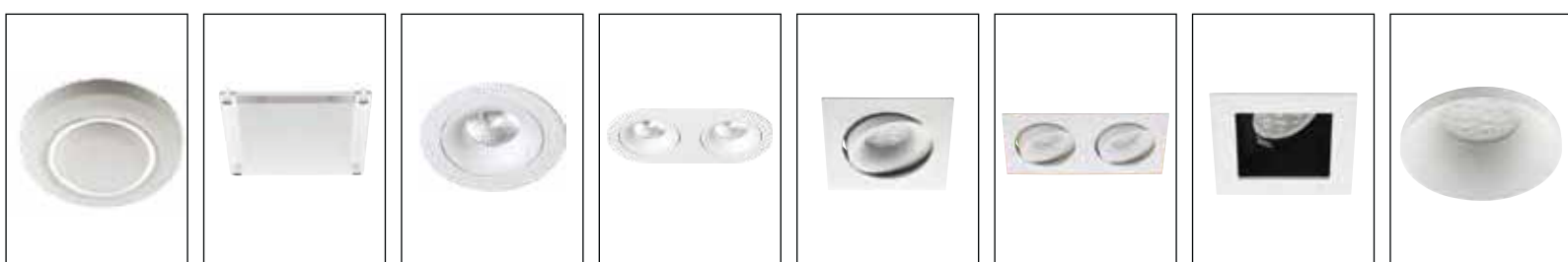

JC762 52 JD227 123 JD228 72 JD229 72 JD230 73 JD231 73 JD232 76 JD233 74



JD501
129



JD502
129



JD504
129



JD511
123



JD514
129



JD517, JD518
127



JD519
127



JD521
137



JD523
137



JD525
141



JD526
137



JD527, JD528,
JD529
124



JD530
125



JD532, JD533
125



JD532 H
126



JD540
128



JD541
128



JD544
127



JD550
126



JD551
126



JD556
128



JD557
128



JD561
123



JD566
140



JD568
126



JD570
140



JD616
141



JD617
136



JD620
138



JD621
138



JD622
138



JD623
139



JD624
139



JD634
76



JD635
141



JD639
139



JD640
74



JD641
140



JD642
136



JD643
140



JE108, JE113,
JE114, JE121,
JE128
58



JE118, JE136
62



JE208, JE213,
JE214, JE221,
JE228
59



JE218
62



JE318
60

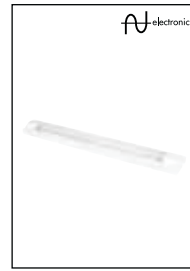

JE336
60



JE408
63



JE508, JE513
62



JE718
61



JE736
61



JG654
213

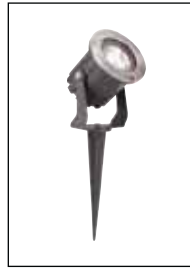

JG655
213



JG657
215



JG658
215



JG659
168



JG661
214



JG662
214



JG671
169



JG673
169



JG674
211



JG675
169



JG676
168



JG677
168



JG681
213



JG682
212



JG683
212



JG685
222



JG810
203



JG811
203



JG813
200



JG821
200



JG822
200



JG823
201



JG824
201



JG826
185



JG828
185



JG831
207



JG832
207



JG833
207



JG835
202



JG836
202



JG837
202



JG838
202



JG839
203



JG840
206



JG841
206



JG844
205



JG845
205



JG846
205



JG930
210



JG931
206



JG932
206



JG933
210



JG934
210



JG935
211



JG947
204



JG948
204



JG949
204



JG956
211



JH502
97



JH503
93



JH505
84



JH509
80



JH510
80



JH511
89



JH513
96



JH515
78



JH516
80



JH521
81



JH522
89



JH527
96



JH537
99



JH541
81



JH543
98



JH557
101



JH558
101



JH560
99



JH561
96



JH564
82



JH565
83



JH566
88



JH567
97



JH573
84



JH575
93



JH582
97



JH590
88



JH591
88



JH593
86



JH594
88



JH602
86



JH603
77



JH604
99



JH605
87



JH606
87



JH611
100



JH613
87



JH615
103



JH616
102



JH618
78



JH619
82



JH620
83

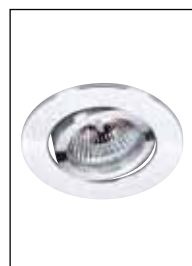

JH622
86



JH624
78



JH626
89



JH627
81



JH628
81



JH629
89



JH632
98

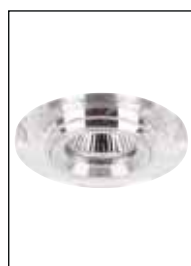

JH635
103



JH638
77



JH639
77

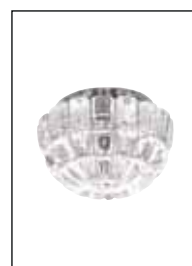

JH641
94



JH642
95



JH647
102



JH649
102



JH650
82



JH651
86



JH657
98



JH658
98



JH659
75



JH660
75



JH661
84



JH671
76



JH676
85

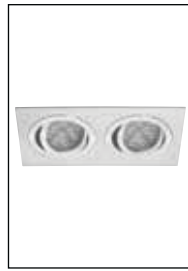

JH677
85



JH678
85



JH680
79



JH681
94

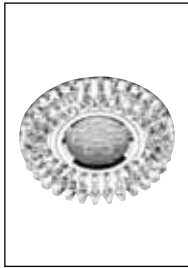

JH683
100



JH684
74



JH688
75



JH690
94

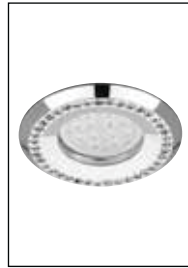

JH692
92

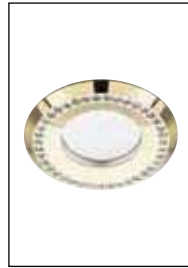

JH693
92



JH696
87



JH697
83



JH699
93



JH700
92

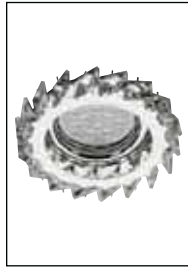

JH701
95



JH702
95

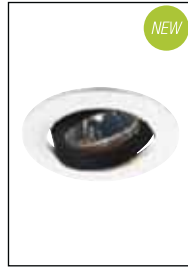

JH710
80



JH738
134

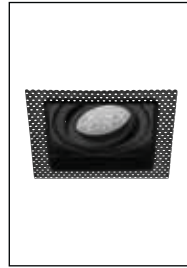

JH739
135



JK013, JK018
230



JK026
230



JK068
232



JK069
232



JK218
229



JK253, JK254,
JK256
230



JK260
229



JK261
229

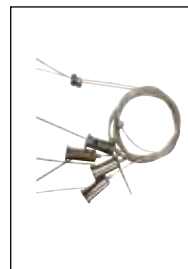

JK999
228



JM010
154



JM011
154



JM015
155



JM017
155



JP461
219



JP463
219



JR002, JR007
142



JR003, JR004
143



JR005, JR006
143



JR008, JR009,
JR010
142



JR011
152



JR012
152



JR014
153



JR016
153



JR022
152



JR023
152



JR024
151



JR031
153



JR644
150

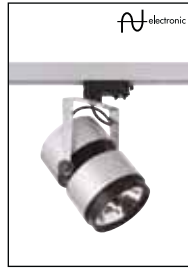

JR645
150



JR646
150



JR649
150



JR652
151



JR654
151



JR655
148



JR656
148



JR657
148



JS475
232



JS476
231



JS479
232



JS480
231



JS485
231



JS486
231



JW526
186



JW527
176



JW640
153



JW672 SS
196

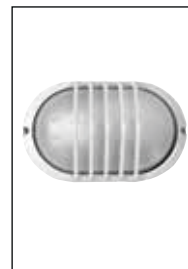

JW682
184



JW684
184



JW690
184



JW700
190



JW901
185



JW904
182



JW905
182



JW906
182



JW907
182



JW917
180



JW918
180



JW919
180



JW926
179



JW927
179



JW928
177



JW929
186



JW930
186



JW931
187



JW932
187



JW933
187



JW934
189



JW935
187



JW936
176



JW937
176



JW938
35



JW939
189



JW941
181



JW943
188



JW944
35



JW945
35



JW946
177



JW947
177



JW952
188



JW958
181



JW959
181



JW960
178



JW961
178



JW962
189



JW963
183



JW964
178



JW969
188



JW974
186



JY001
222



JZ010
227



LA009
225



LA011
225



LA013
224



LA014
224



LA431
227



LA480
226



LA481
227



LA533
227



LA682, LA683
226



LA687
226



LC436
174



LC437
56



LC438
56

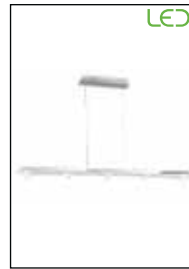

LC439
28



LC440
51



LC441, LC442
51



LC453, LC454
54



LC455, LC456
55



LC458
56



LC473
42



LC474
42



LC475
43



LC476
43



LC480
54



LC481
55



LD397
122



LD410
134



LD411
134



LD412
118



LD413
120



LD414
120



LD415, LD416
122



LD433
133



LD434
133



LD435
135



LD436
135



LD467
119



LD470, LD471,
LD472, LD474
121



LD473
120



LD475
136



LD476
132



LD477
132



LD478
132



LE030, LE060,
LE090, LE120
64



LE108, LE121,
LE128
63



LE208, LE218
69

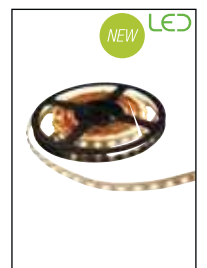

LE209, LE219
68



LE210
67



LE220
67



LE421, LE428
63



LE486
57



LE487
57

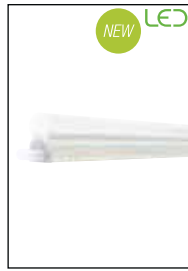

LE494, LE495,
LE496, LE497
64



LE498
65



LG925
167



LG926
167



LG927
165



LG947
165



LG977
166



LG978
166



LG979
167



LG980
166



LG981
212



LG982
165



LG983
167



LG984
208



LG985
212



LG986
208



LG987
213



LG988
166



LG989
209



LK965
233



LK966, LK967
236



LK968
234



LK970, LK971
237

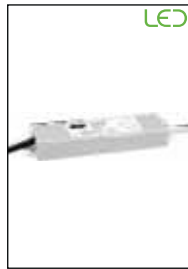

LK973
233



LK974
236



LK975, LK976
234



LK977, LK978
235



LK991
228



LP401
216



LP403
216



LP405
216



LP412
218



LP413
217



LP414
217



LP421
218

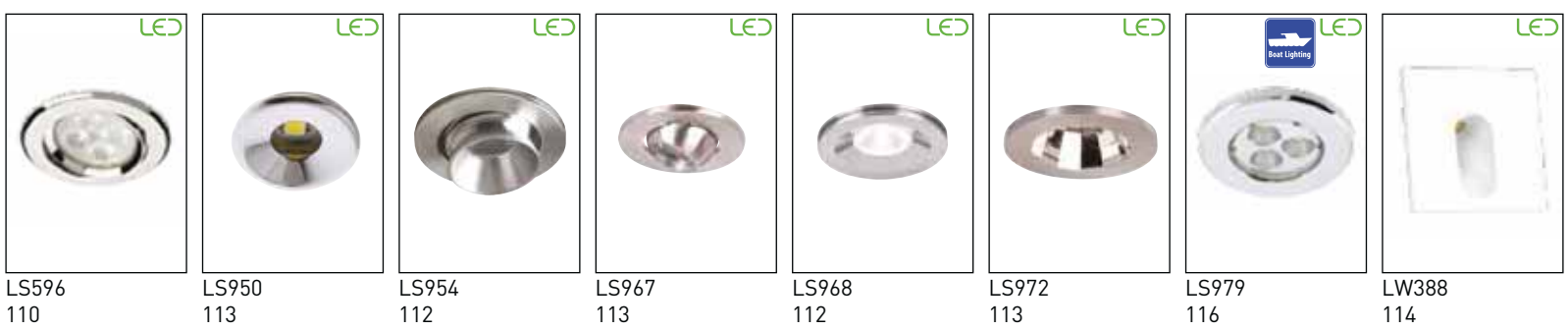

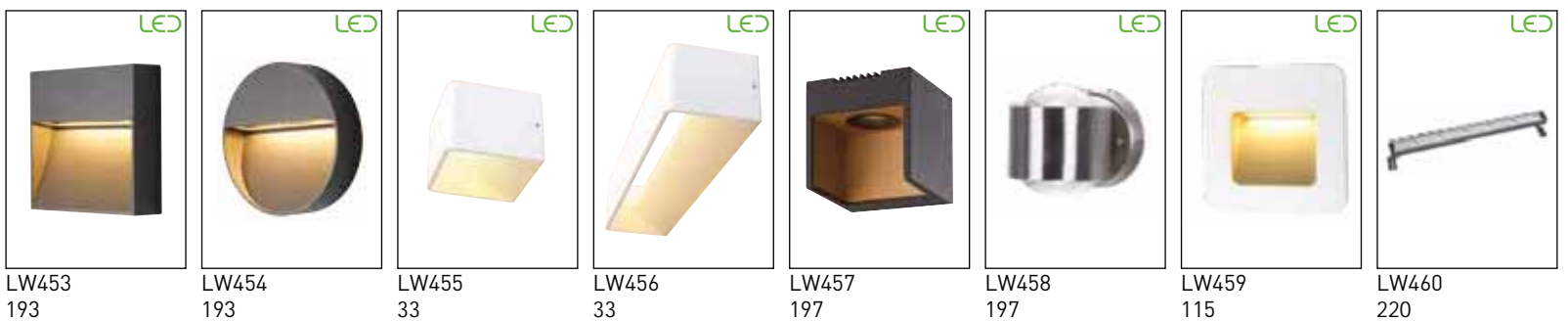
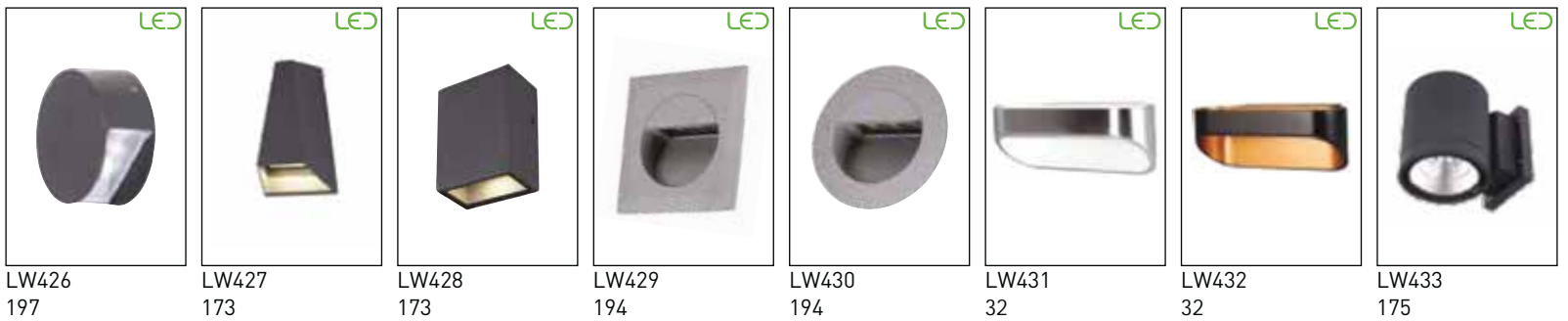



LW469
33



LW470
173



LW942
195



LW966
116



LW971
115



LW972
194



LW973, LW974
196



LW975
195



LW977
195



LW983
116



LW984
192



LW985
192



SİLİKON STÜDYO
158-163



EV619



EV624

EV620

**Malzeme:**

- Alüminyum gövde
- 1.5 metre kablolu

Material:

- Aluminium housing
- Supplied with 1.5 meter cable

Renk:

- Bakır & Beyaz

Colour:

- Copper & White

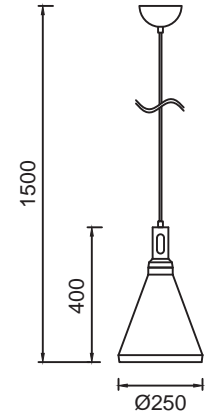

E 27



Spiral

20 W



32x30x30 cm / 1 pcs

Y

IP

20

EV622

**Malzeme:**

- Alüminyum gövde
- 1.5 metre kablolu

Material:

- Aluminium housing
- Supplied with 1.5 meter cable

Renk:

- Bakır & Beyaz

Colour:

- Copper & White

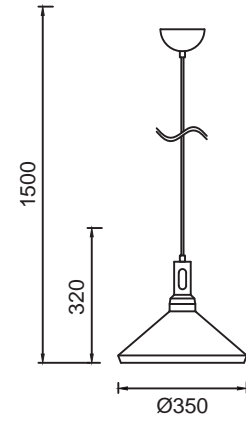

E 27



Spiral

20 W



41x41x23 cm / 1 pcs

Y

IP

20

EV621

**Malzeme:**

- Alüminyum gövde
- 1.5 metre kablolu

Material:

- Aluminium housing
- Supplied with 1.5 meter cable

Renk:

- Bakır & Beyaz

Colour:

- Copper & White

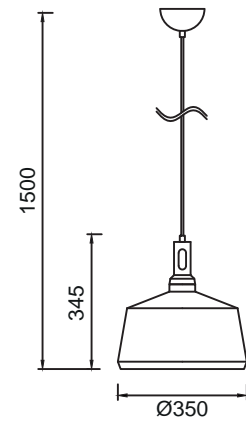

E 27



Spiral

20 W



41x41x29 cm / 1 pcs

Y

IP

20

EV615

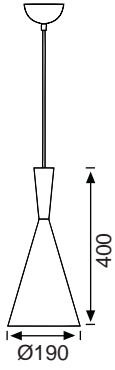

Malzeme:

- Alüminyum gövde
- 1.5 metre kablolu

Material:

- Aluminium housing
- Supplied with 1.5 meter cable

Renk:

- Siyah& Altın

Colour:

- Black & Gold



E 27



Spiral

20 W



47x26x26 / 1 pc

Y

IP

20

EV616

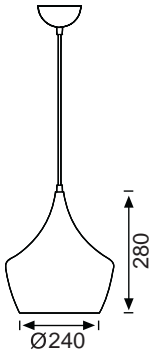

Malzeme:

- Alüminyum gövde
- 1.5 metre kablolu

Material:

- Aluminium housing
- Supplied with 1.5 meter cable

Renk:

- Siyah& Altın

Colour:

- Black & Gold



E 27



Spiral

20 W



35x32x32 / 1 pc

Y

IP

20

EV614

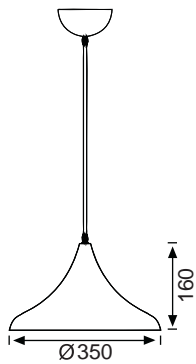

Malzeme:

- Alüminyum gövde
- 1.5 metre kablolu

Material:

- Aluminium housing
- Supplied with 1.5 meter cable

Renk:

- Siyah& Altın

Colour:

- Black & Gold



E 27



Spiral

20 W



45x23x45 cm / 1 pc

Y

IP

20

EV618

**Malzeme:**

- Alüminyum gövde
- 1.5 metre kablolu

Material:

- Aluminium housing
- Supplied with 1.5 meter cable

Renk:

- Siyah & Altın

Colour:

- Black & Gold

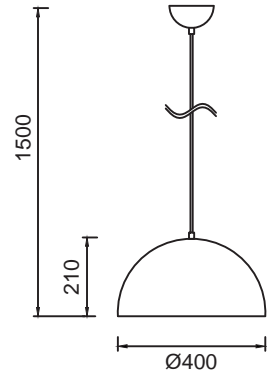

E 27



Spiral

20 W



44x44x23 cm / 1 pcs

Y

IP

20

EV619

**Malzeme:**

- Alüminyum gövde
- 1.5 metre kablolu

Material:

- Aluminium housing
- Supplied with 1.5 meter cable

Renk:

- Bakır & Beyaz

Colour:

- Copper & White

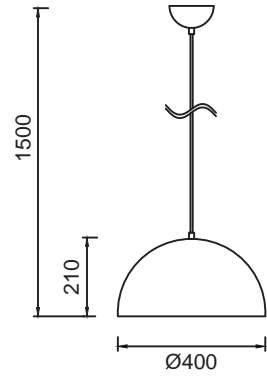

E 27



Spiral

20 W



44x44x23 cm / 1 pcs

Y

IP

20

EV623

**Malzeme:**

- Alüminyum gövde
- 1.5 metre kablolu

Material:

- Aluminium housing
- Supplied with 1.5 meter cable

Renk:

- Bakır & Beyaz

Colour:

- Copper & White

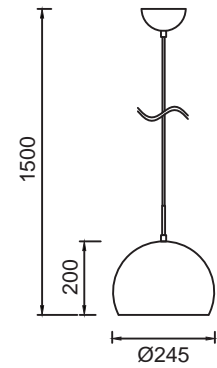

E 27



Spiral

20 W



34.5x29.5x34 cm / 1 pcs

Y

IP

20

EV624

NEW

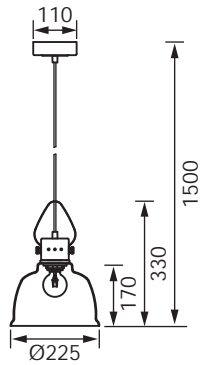
**Malzeme:**

- Karbon çelik
- Cam
- 1,5 metre kablolu

Material:

- Carbon steel
- Glass
- Supplied with 1,5 meter cable

Renk:

- Altın şampanya

Colour:

- Champagne gold



E27

Spiral

20 W

45x31x25 cm / 1 pc

Y

IP
20

NEW

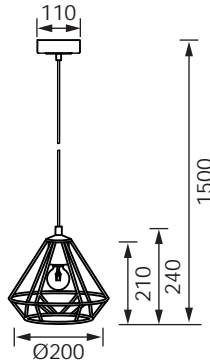
**Malzeme:**

- Karbon çelik
- 1,5 metre kablolu

Material:

- Carbon steel
- Supplied with 1,5 meter cable

Renk:

- Bakır

Colour:

- Copper



EV625

E27

Spiral

20 W

59x44x31 cm / 6 pc

Y

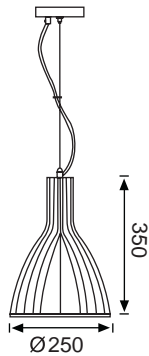
IP
20**Malzeme:**

- Alüminyum gövde
- 1.5 m şeffaf kablolu
- Elektrostatik toz boyama

Material:

- Aluminium housing
- With 1.5 m transparent cable
- Electrostatic powder coated

Renk:

- Siyah

Colour:

- Black



EV617

E 27

Spiral

20 W

46x29x29 / 1 pc

Y

IP
20

EV428

**Malzeme:**

- Alüminyum gövde
- Altın renkli Alüminyum reflektör
- 1.5 m siyah kablolu
- Elektrostatik toz boyama

Material:

- Aluminium housing
- Aluminium reflector in gold colour
- With 1.5 m black cable
- Electrostatic powder coated

Renk:

- Siyah & Altın

Colour:

- Black & Gold

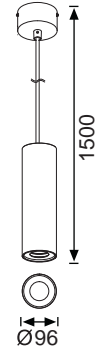

GU 10



LED Par 16

5 W



23x54x44 cm / 10 pcs



20

EV429

**Malzeme:**

- Alüminyum gövde
- 1.5 m şeffaf kablolu

Material:

- Aluminium housing
- With 1.5 m transparent cable

Renk:

- Fırçalanmış Alüminyum

Colour:

- Brushed Aluminium

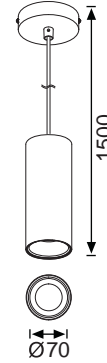

GU 10



LED Par 16

5 W



18x42x47 cm / 10 pcs



20

EV430

**Malzeme:**

- Alüminyum gövde
- 1.5 m şeffaf kablolu
- Elektrostatik toz boyama

Material:

- Aluminium housing
- With 1.5 m transparent cable
- Electrostatic powder coated

Renk:

- Beyaz

Colour:

- White

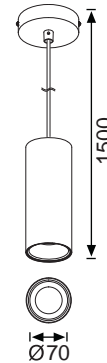

GU 10



LED Par 16

5 W



18x42x47 cm / 10 pcs



20

EV427

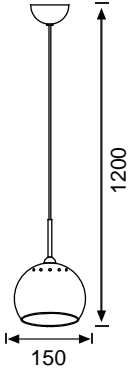

Malzeme:

- Metal gövde
- Kaplama

Material:

- Steel housing
- Plated

Renk:

- Krom

Colour:

- Chrome



E 14



Spiral

15 W



62x42x23 cm / 6 pcs



IP

20

EV422

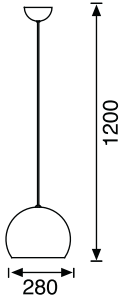

Malzeme:

- Metal gövde
- Kaplama

Material:

- Steel housing
- Plated

Renk:

- Krom

Colour:

- Chrome

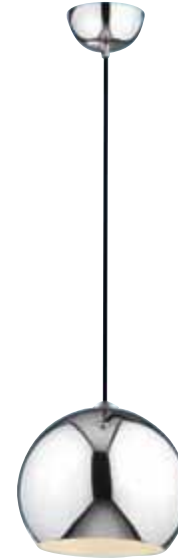

E 14



Spiral

15 W



34.5x29.5x34 cm / 1 pc



IP

20

EV423

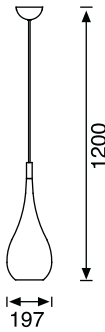

Malzeme:

- Metal gövde
- Alüminyum reflektör
- Kaplama

Material:

- Steel housing
- Aluminium reflector
- Plated

Renk:

- Krom

Colour:

- Chrome



E 14



Dulux Star

15 W



21x21x54 cm / 1 pc



IP

20

EV105

**Malzeme:**

- Metal gövde
- Buzlu cam
- Kaplama

Material:

- Steel housing
- Frosted glass
- Plated

Renk:

- Saten Nikel

Colour:

- Satin Nickel

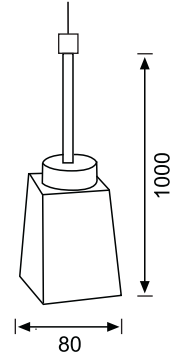

E 14



Classic B

20 W



68,5x28x23,5 cm / 10 pcs

Y

IP

20

EV421

**Malzeme:**

- Metal gövde
- Beyaz cam
- Kaplama
- Ampullü

Material:

- Steel housing
- White glass
- Plated
- Supplied with suitable bulb

Renk:

- Beyaz

Colour:

- White

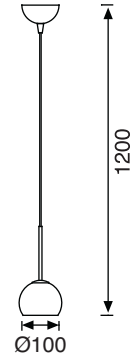

GU 10



LED Par 16

5 W



35x29x21 cm / 6 pcs

Y

IP

20

LC439

**Malzeme:**

- Metal gövde

Material:

- Steel housing

Renk:

- Beyaz

Colour:

- White

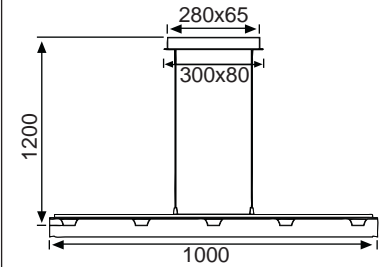

LED

LED Tipi

COB LED

Renk Sıcaklığı

3000 K

Işık Akısı

2000 lm

Sistem Gücü

25 W

Voltaj

230V



104x16x12 cm / 1 pc

Y

IP

20

EV211

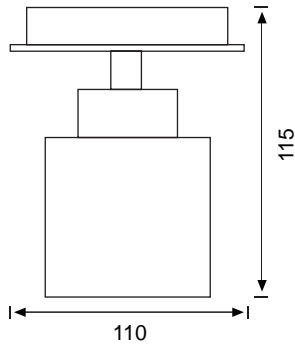

Malzeme:

- Metal gövde
- Buzlu cam
- Kaplama
- Ampullü

Material:

- Steel housing
- Frosted glass
- Plated
- Supplied with suitable bulb

Renk:

- Krom

Colour:

- Chrome



G 9



Halopin

40 W



62x25x38 cm / 30 pcs

Y

IP

20

EV121

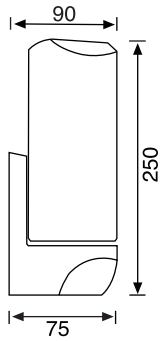

Malzeme:

- Metal gövde
- Opal cam
- Kaplama

Material:

- Steel housing
- Opal glass
- Plated

Renk:

- Saten Nikel

Colour:

- Satin Nickel



E 27



Dulux Star

15 W



74x30x37 cm / 10 pcs

Y

IP

20

EV404

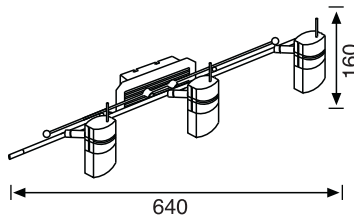

Malzeme:

- Metal gövde
- Opal cam
- Kaplama
- Dahili trafo
- Ampullü

Material:

- Steel housing
- Opal glass
- Plated
- Built-in transformer
- Supplied with suitable bulb

Renk:

- Saten Nikel

Colour:

- Satin Nickel



G 4



Halostar

3x20 W



78x36x44 cm / 8 pcs

Y

IP

20

EV116



Malzeme:
• Metal gövde
• Kaplama

Material:
• Steel housing
• Plated

Renk:
• Saten Nikel

Colour:
• Satin Nickel

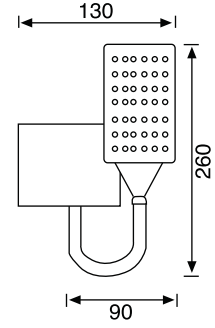

E 27

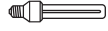

Dulux Star

15 W



51x32x29.5 cm / 10 pcs

Y

IP

20

EV501



Malzeme:
• Alüminyum gövde
• Buzlu cam

Material:
• Aluminium housing
• Frosted glass

Renk:
• Alüminyum

Colour:
• Aluminium

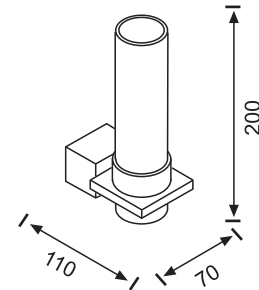

E 14



Spiral

12 W



37.5x33.5x23 cm / 12 pcs

Y

IP

20

EV502



Malzeme:
• Alüminyum gövde
• Buzlu cam

Material:
• Aluminium housing
• Frosted glass

Renk:
• Alüminyum

Colour:
• Aluminium

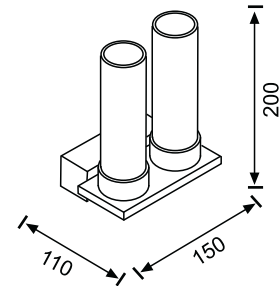

E 14



Spiral

2x12 W



43.5x33.5x38 cm / 12 pcs

Y

IP

20

EV707



Malzeme:
• Metal gövde
• Opal cam

Material:
• Steel housing
• Opal glass

Renk:
• Opal

Colour:
• Opal



E 27



Spiral

15 W



100x36x44 cm / 10 pcs

Y

IP

20

LED

EPISTAR

NEW

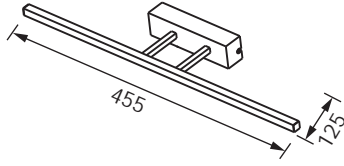

- Malzeme:**
- Alüminyum gövde
 - Krom kaplama
 - Dahili LED sürücülü

- Material:**
- Aluminium housing
 - Chrome plated
 - Built-in LED driver

- Renk:**
- Krom
- Colour:**
- Chrome

EV215



LED Tipi	Renk Sıcaklığı	Işık Akısı	Sistem Gücü	Voltaj		Y	IP
Epistar LED	3000 K	400 lm	8W	230 V	40x21x46,5 cm / 12 pcs		20

LED

SHARP

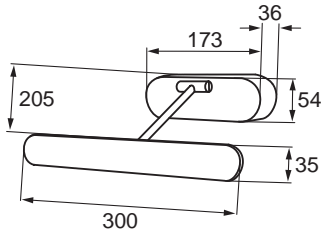

- Malzeme:**
- Alüminyum gövde
 - Dahili LED sürücülü

- Material:**
- Aluminium housing
 - Built-in LED driver

- Renk:**
- Antik sarı
- Colour:**
- Brass

LW463



LED Tipi	Renk Sıcaklığı	Işık Akısı	Sistem Gücü	Voltaj		Y	IP
SHARP LED	3000 K	620 lm	2x5 W	230V	51.5x34.5x39.4 cm / 8 pcs		20

LED

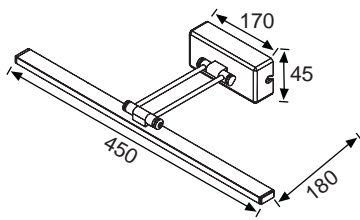

- Malzeme:**
- Metal gövde
 - Kaplama
 - Dahili LED sürücülü

- Material:**
- Steel housing
 - Plated
 - Built-in LED driver

- Renk:**
- Krom
- Colour:**
- Chrome

EV309



LED Tipi	Renk Sıcaklığı	Işık Akısı	Sistem Gücü	Voltaj		Y	IP
SMD LED	3000 K	500 lm	8 W	230V	47x35x35 cm / 12 pcs		20

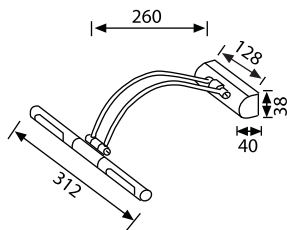

- Malzeme:**
- Metal gövde
 - Alüminyum reflektör
 - Dahili trafo
 - Ampüllü

- Material:**
- Steel housing
 - Aluminium reflector
 - Built-in transformer
 - Supplied with suitable bulb

- Renk:**
- Saten Nikel
- Colour:**
- Satin Nickel

EV306



						Y	IP
G 4	Halostar	2x20 W			53x52x29 cm / 20 pcs		20

LW423

**Malzeme:**

- Alüminyum gövde
- Elektrostatik toz boyama
- Dahili LED sürücülü

Material:

- Aluminium housing
- Electrostatic powder coated
- Built-in LED driver

Renk:

- Mat Beyaz

Colour:

- Matt White

CITIZEN™ inside

LED

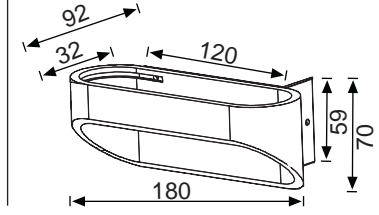

LED Tipi	Renk Sıcaklığı	Işık Akısı	Sistem Gücü	Voltaj
Citizen LED	3000 K	400 lm	6 W	230V

43.5x30x28 cm / 12 pcs

Y

IP

20

LW431

**Malzeme:**

- Alüminyum gövde
- Dahili LED sürücülü

Material:

- Aluminium housing
- Built-in LED driver

Renk:

- Fırçalanmış Alüminyum

Colour:

- Brushed Aluminium

CITIZEN™ inside

LED

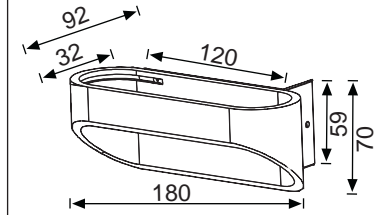

LED Tipi	Renk Sıcaklığı	Işık Akısı	Sistem Gücü	Voltaj
Citizen LED	3000 K	400 lm	6 W	230V

43.5x30x28 cm / 12 pcs

Y

IP

20

LW432

**Malzeme:**

- Alüminyum gövde
- Elektrostatik toz boyama
- Dahili LED sürücülü

Material:

- Aluminium housing
- Electrostatic powder coated
- Built-in LED driver

Renk:

- Siyah & Altın

Colour:

- Black & Gold

CITIZEN™ inside

LED

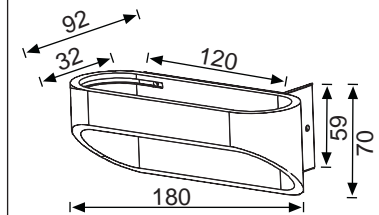

LED Tipi	Renk Sıcaklığı	Işık Akısı	Sistem Gücü	Voltaj
Citizen LED	3000 K	400 lm	6 W	230V

43.5x30x28 cm / 12 pcs

Y

IP

20

LW467

**Malzeme:**

- Alüminyum gövde
- Su bazlı boya
- Dahili LED sürücülü

Material:

- Aluminium housing
- Water painted
- Built-in LED driver

Renk:

- Mat Beyaz

Colour:

- Matt white

CITIZEN™ inside

LED

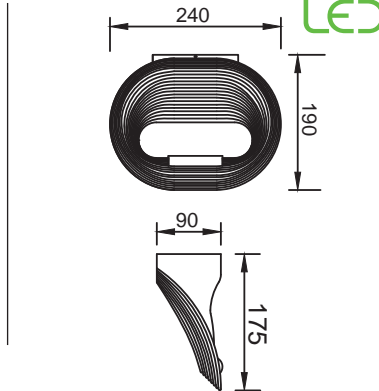

LED Tipi	Renk Sıcaklığı	Işık Akısı	Sistem Gücü	Voltaj
COB LED	3000 K	650 lm	13 W	230V

51x25x38 cm / 10 pcs

Y

IP

20

LED

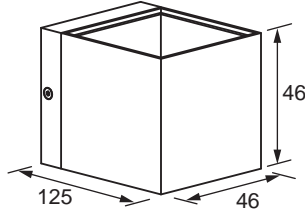
**Malzeme:**

- Alüminyum gövde
- Elektrostatik toz boyama
- Dahili LED sürücülü

Material:

- Aluminium housing
- Electrostatic powder coated
- Built-in LED driver

Renk:

- Siyah & Altın

Colour:

- Black & Gold



LW469

LED Tipi	Renk Sıcaklığı	Işık Akısı	Sistem Gücü	Voltaj		Y	IP
COB LED	3000 K	300 lm	6 W	230V	 54.5x23x31 cm / 20 pcs		20

LED

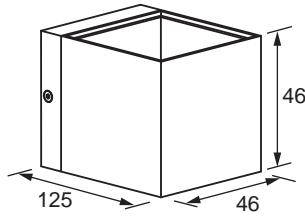
**Malzeme:**

- Alüminyum gövde
- Elektrostatik toz boyama
- Dahili LED sürücülü

Material:

- Aluminium housing
- Electrostatic powder coated
- Built-in LED driver

Renk:

- Beyaz & gümüş

Colour:

- White & silver



LW468

LED Tipi	Renk Sıcaklığı	Işık Akısı	Sistem Gücü	Voltaj		Y	IP
COB LED	3000 K	300 lm	6 W	230V	 54.5x23x31 cm / 20 pcs		20

LED

San'an inside

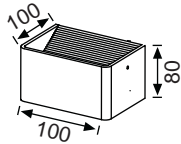
**Malzeme:**

- Alüminyum gövde
- Dahili LED sürücülü
- Su bazlı boya

Material:

- Aluminium housing
- Built-in Led driver
- Water painted

Renk:

- Mat Beyaz

Colour:

- Matt White



LW455

LED Tipi	Renk Sıcaklığı	Işık Akısı	Sistem Gücü	Voltaj		Y	IP
San'an SMD LED	3000 K	500 lm	6 W	230V	 45x11x23 cm / 10 pcs		54

LED

San'an inside

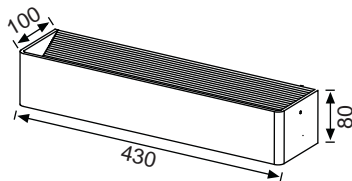
**Malzeme:**

- Alüminyum gövde
- Dahili LED sürücülü
- Su bazlı boya

Material:

- Aluminium housing
- Built-in LED driver
- Water painted

Renk:

- Mat Beyaz

Colour:

- Matt White

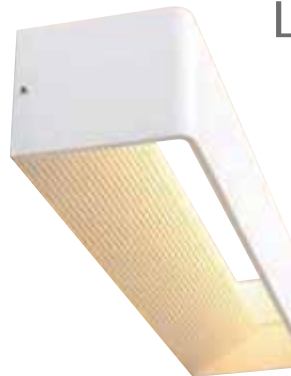

LW456

LED Tipi	Renk Sıcaklığı	Işık Akısı	Sistem Gücü	Voltaj		Y	IP
San'an SMD LED	3000 K	1100 lm	12 W	230V	 45x44x23 cm / 10 pcs		54

EV505

**Malzeme:**

- Alüminyum gövde
- Anahtarlı
- Elektrostatik toz boyama

Material:

- Aluminium body
- With switch
- Electrostatic powder painted

Renk:

- Beyaz & Siyah

Colour:

- White & Black

NEW

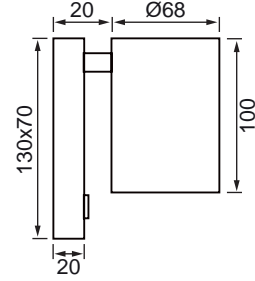

GU 10



LED Par 16

5 W



41x32x36 cm / 24 pcs



IP

20

LW451

**Malzeme:**

- Paslanmaz çelik gövde
- Anahtarlı
- Dahili LED sürücülü

Material:

- S.S. housing
- With switch
- Built-in LED driver

Renk:

- Krom

Colour:

- Chrome

EPISTAR inside

LED

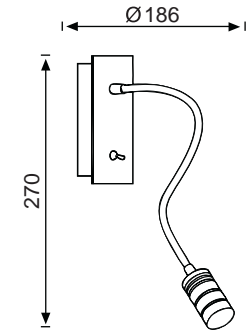
**LED Tipi**

Epistar Power LED

Renk Sıcaklığı

3000 K

Sistem Gücü

1 W

Voltaj

230V



60x20x15 cm / 10 pcs



IP

20

LW450

**Malzeme:**

- Paslanmaz çelik gövde
- Anahtarlı
- Dahili LED sürücülü

Material:

- S.S. housing
- With switch
- Built-in LED driver

Renk:

- Krom

Colour:

- Chrome

LED

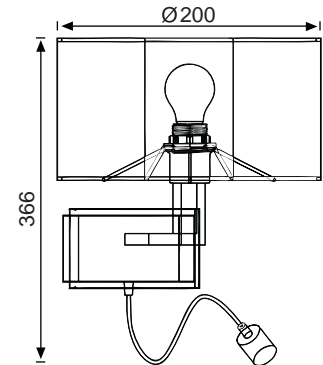

E27 & LED



Spiral

15 W & 1 W LED

Renk Sıcaklığı

3000 K



36x30x19 cm / 1 pc



IP

20

JW938

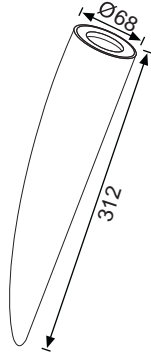

Malzeme:
• Alüminyum gövde

Material:
• Aluminium housing

Renk:
• Fırçalanmış
Alüminyum

Colour:
• Brushed
Aluminium



GU 10

LED Par 16

5 W

55.9x37x32.8 cm / 15 pcs

Y

IP
20

JW944

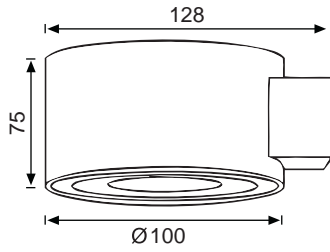

Malzeme:
• Alüminyum gövde
• Su bazlı boya

Material:
• Aluminium housing
• Water painted

Renk:
• Mat Beyaz &
Mat Siyah

Colour:
• Matt White &
Matt Black



GU 10

LED Par 16

5 W

57x41x18 cm / 30 pcs

Y

IP
20

JW945

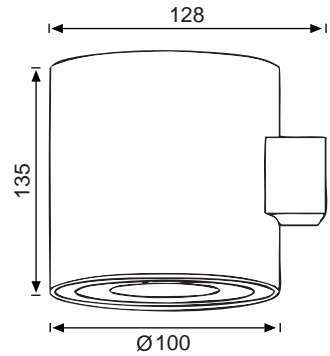

Malzeme:
• Alüminyum gövde
• Su bazlı boya

Material:
• Aluminium housing
• Water painted

Renk:
• Mat Beyaz &
Mat Siyah

Colour:
• Matt White &
Matt Black



GU 10

LED Par 16

2x 5 W

72x44x24 cm / 30 pcs

Y

IP
20



EV029

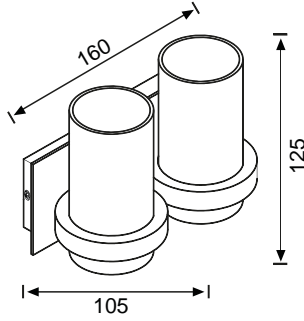

Malzeme:
• Alüminyum gövde
• Buzlu cam

Material:
• Aluminium housing
• Frosted glass

Renk:
• Alüminyum

Colour:
• Aluminium



G 9



Halopin

2x40 W



58x50x43.5 cm / 16 pcs

Y

IP

20

EV002

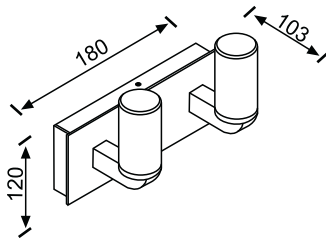

Malzeme:
• Paslanmaz çelik gövde
• Buzlu cam
• Kaplama

Material:
• Stainless steel housing
• Frosted glass
• Plated

Renk:
• Krom

Colour:
• Chrome



G 9



Halopin

2x40 W



59x36.5x27.5 cm / 10 pcs

Y

IP

44

EV006

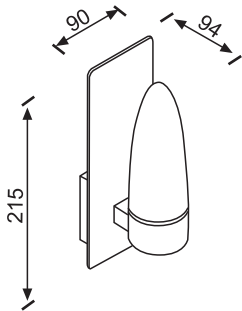

Malzeme:
• Paslanmaz çelik gövde
• Opal cam

Material:
• Stainless steel housing
• Opal glass

Renk:
• Krom

Colour:
• Chrome



E14



Halogen Eco Classic B

30 W



28x26.5x26 cm / 4 pcs

Y

IP

44

EV008

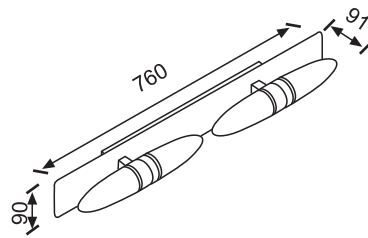

Malzeme:
• Paslanmaz çelik gövde
• Opal cam

Material:
• Stainless steel housing
• Opal glass

Renk:
• Krom

Colour:
• Chrome



E14



Halogen Eco Classic B

4x30 W



91.5x51.5x14.5 cm / 5 pcs

Y

IP

44

EV021



- Malzeme:**
- Paslanmaz çelik gövde
 - Opal cam
 - Kaplama

- Material:**
- *Stainless steel housing*
 - *Opal glass*
 - *Plated*

- Renk:**
- Krom

- Colour:**
- Chrome

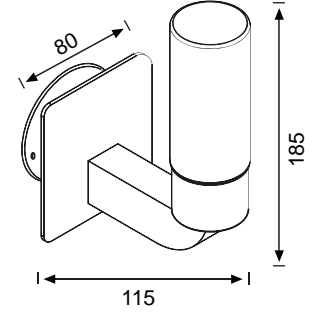

E14



Spiral

12 W



52x46.5x35 cm / 16 pcs



44

EV022



- Malzeme:**
- Paslanmaz çelik gövde
 - Opal cam
 - Kaplama

- Material:**
- *Stainless steel housing*
 - *Opal glass*
 - *Plated*

- Renk:**
- Krom

- Colour:**
- Chrome

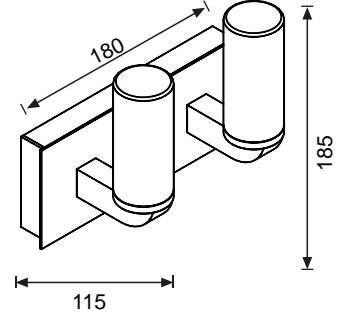

E14



Spiral

2x12 W



62x51.5x36.5 cm / 12 pcs



44

EV023



- Malzeme:**
- Paslanmaz çelik gövde
 - Opal cam
 - Kaplama

- Material:**
- *Stainless steel housing*
 - *Opal glass*
 - *Plated*

- Renk:**
- Krom

- Colour:**
- Chrome

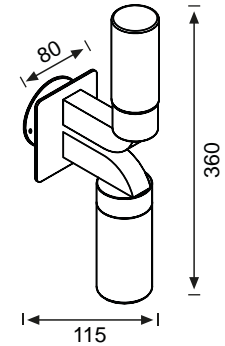

E14



Spiral

2x12 W



52x51.5x41 cm / 12 pcs



44

EV308

A-electronic

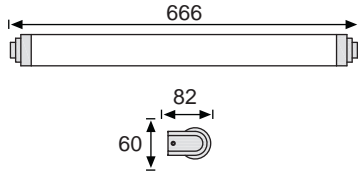
**Malzeme:**

- Alüminyum gövde
- Akrilik difüzör
- Dahili elektronik balast
- 3000 K ampüllü

Material:

- Aluminium housing
- Acrylic diffuser
- Built-in electronic ballast
- Supplied with 3000 K bulb

Renk:

- Krom

Colour:

- Chrome



T 5

24 W



70x39.5x24.5cm / 8 pcs

Y

IP

44

A-electronic

EV313

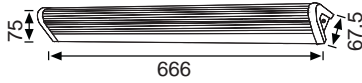
**Malzeme:**

- Alüminyum gövde
- Akrilik difüzör
- Dahili elektronik balast
- 3000 K ampüllü

Material:

- Aluminium housing
- Acrylic diffuser
- Built-in electronic ballast
- Supplied with 3000 K bulb

Renk:

- Krom

Colour:

- Chrome



T 5

24 W



62.5x32x26 cm / 12 pcs

Y

IP

20

A-electronic

EV315

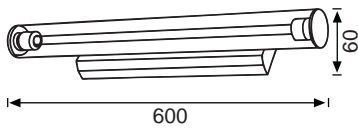
**Malzeme:**

- Metal gövde
- Şeffaf cam
- 3000 K ampüllü
- Dahili elektronik balast
- Kaplama

Material:

- Steel housing
- Clear glass
- Supplied with 3000 K bulb
- Built in electronic ballast
- Plated

Renk:

- Krom

Colour:

- Chrome



T 5

24 W



70x39.5x24.5cm / 8 pcs

Y

IP

20

EV304



Malzeme:

- Metal gövdeli ayna
- Kaplama
- İpli anahtarlı
- Dahili LED sürücülü

Material:

- Steel housing with mirror
- Plated
- With pull switch
- Built-in LED driver

- Renk:**
- Krom

- Colour:**
- Chrome

LED

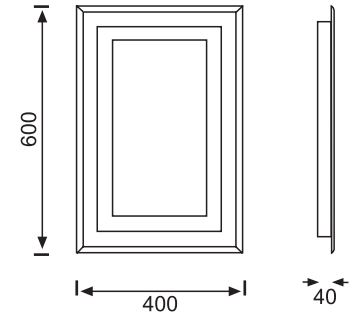

LED Tipi	Renk Sıcaklığı	Işık Akısı	Sistem Gücü	Volтаж		Y	IP
LED	6500 K	50 lm	3.6 W	230V	47.5x23x68 cm / 2 pcs		44

LW424



Malzeme:

- Zamak gövde
- Opal cam
- Kaplama
- Dahili LED sürücülü

Material:

- Die-cast zinc housing
- Opal glass
- Plated
- Built-in LED driver

- Renk:**
- Krom

- Colour:**
- Chrome

CREE inside

LED

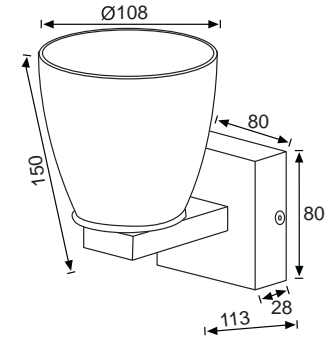

LED Tipi	Renk Sıcaklığı	Işık Akısı	Sistem Gücü	Volтаж		Y	IP
Cree LED	3000 K	100 lm	4 W	230V	51.3x49x30.6 cm / 12 pcs		20

EV413



Malzeme:

- Zamak gövde
- Porselen kafa
- Kaplama

Material:

- Die-cast zinc housing
- Porcelain shade
- Plated

- Renk:**
- Krom

- Colour:**
- Chrome

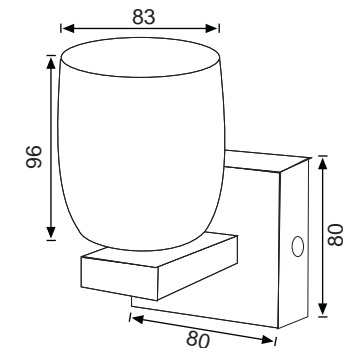

						Y	IP
G 9	Halopin	40 W			56x42x39 cm / 12 pcs		20



LC476



LC473



LC475

LC473



- Malzeme:**
- Fırçalanmış alüminyum gövde
 - Anahtarlı
 - Dahili LED sürücülü

- Material:**
- *Brushed aluminium housing*
 - *With switch*
 - *Built-in LED driver*

- Renk:**
- F. Alüminyum

- Colour:**
- B. Aluminium

EDISON inside **LED**

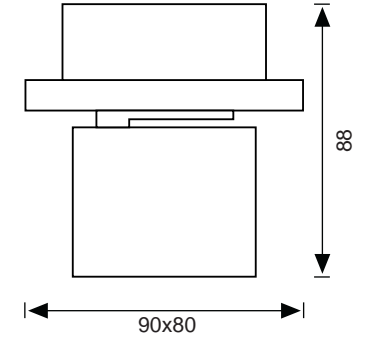

LED Tipi	Renk Sıcaklığı	Işık Akısı	Sistem Gücü	Voltaj	Y	IP	
EDISON COB	3000 K	400 lm	6 W	230V	24	52x32x24 cm / 30 pcs	20

LC474



- Malzeme:**
- Fırçalanmış alüminyum gövde
 - Dahili LED sürücülü

- Material:**
- *Brushed aluminium housing*
 - *Built-in LED driver*

- Renk:**
- F. Alüminyum

- Colour:**
- B. Aluminium

EDISON inside **LED**

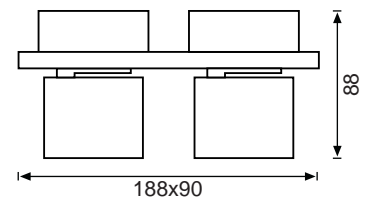

LED Tipi	Renk Sıcaklığı	Işık Akısı	Sistem Gücü	Voltaj	Y	IP	
EDISON COB	3000 K	800 lm	2x6 W	230V	24	52x22x24 cm / 10 pcs	20

LED

EDISON inside

LC475

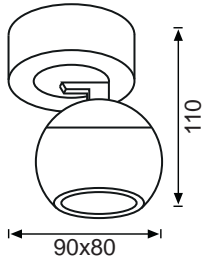
**Malzeme:**

- Alüminyum gövde
- Su bazlı boya
- Anahtarlı
- Dahili LED sürücülü

Material:

- Aluminium housing
- Water painted
- With switch
- Built-in LED driver

Renk:

- Beyaz & Siyah

Colour:

- White & Black



LED Tipi	Renk Sıcaklığı	Işık Akısı	Sistem Gücü	Voltaj	Y	IP
EDISON COB	3000 K	400 lm	6 W	230V	24	52x32x28 cm / 30 pcs

LED

EDISON inside

LC476

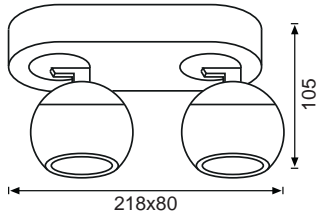
**Malzeme:**

- Alüminyum gövde
- Su bazlı boya
- Dahili LED sürücülü

Material:

- Aluminium housing
- Water painted
- Built-in LED driver

Renk:

- Beyaz & Siyah

Colour:

- White & Black



LED Tipi	Renk Sıcaklığı	Işık Akısı	Sistem Gücü	Voltaj	Y	IP
EDISON COB	3000 K	400 lm	2x6 W	230V	24	52x46x14 cm / 30 pcs

JC065



Malzeme:

- Alüminyum gövde
- Siyah renkli alüminyum reflektör
- Elektrostatik toz boyama

Material:

- Aluminium housing
- Aluminium reflector in black colour
- Electrostatic powder coated

Renk:

- Beyaz & Siyah

Colour:

- White & Black

LED

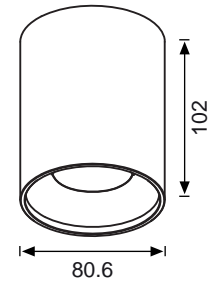

GU 10



LED Par 16

5 W



54x23x31 cm / 20 pcs

Y

IP

20

JC046



Malzeme:

- Alüminyum gövde
- Altın renkli alüminyum reflektör
- Elektrostatik toz boyama

Material:

- Aluminium housing
- Aluminium reflector in gold colour
- Electrostatic powder coated

Renk:

- Siyah & Altın

Colour:

- Black & Gold

LED

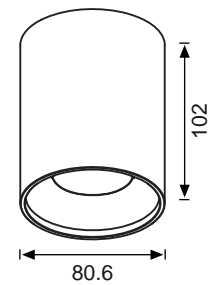

GU 10



LED Par 16

5 W



54x23x31 cm / 20 pcs

Y

IP

20

LED

JC061

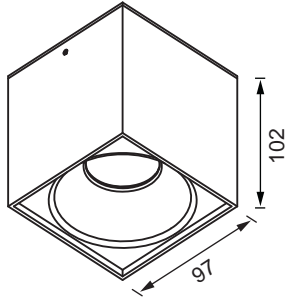
**Malzeme:**

- Alüminyum gövde
- Siyah renkli alüminyum reflektör
- Elektrostatik toz boyama

Material:

- Aluminium housing
- Aluminium reflector in black colour
- Electrostatic powder coated

Renk:

- Beyaz & Siyah

Colour:

- White & Black



GU 10



LED Par 16

5 W



49.5x21x26 cm / 20 pcs

Y

IP

20

LED

JC062

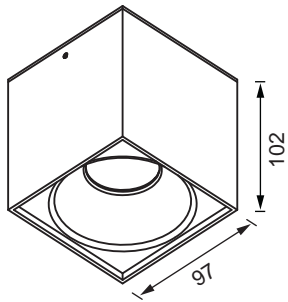
**Malzeme:**

- Alüminyum gövde
- Altın renkli alüminyum reflektör
- Elektrostatik toz boyama

Material:

- Aluminium housing
- Aluminium reflector in gold colour
- Electrostatic powder coated

Renk:

- Siyah & Altın

Colour:

- Black & Gold



GU 10



LED Par 16

5 W



49.5x21x26 cm / 20 pcs

Y

IP

20

JC066



- Malzeme:**
- Alüminyum gövde
 - Elektrostatik toz boyama
- Material:**
- Aluminium housing
 - Electrostatic powder coated

- Renk:**
- Beyaz
- Colour:**
- White

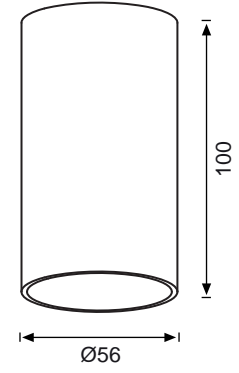

LED



GU 10



LED PAR 16

5 W



34.5x34.5x24 cm / 20 pcs

Y

IP

20

JC067



- Malzeme:**
- Alüminyum gövde
 - Elektrostatik toz boyama
- Material:**
- Aluminium housing
 - Electrostatic powder coated

- Renk:**
- Siyah
- Colour:**
- Black

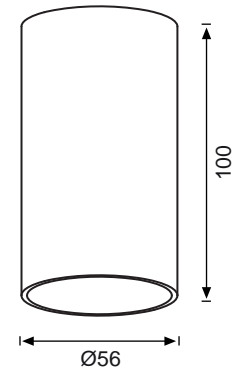

LED



GU 10



LED PAR 16

5 W



34.5x34.5x24 cm / 20 pcs

Y

IP

20

LED NEW

JC068

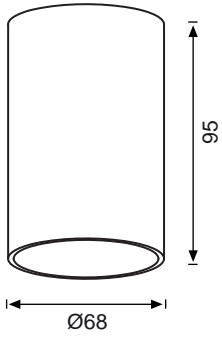
**Malzeme:**

- Alüminyum gövde
- Siyah renkli alüminyum reflektör
- Elektrostatik toz boyama

Material:

- Aluminium housing
- Aluminium reflector in black color
- Electrostatic powder coated

Renk:

- Beyaz & Siyah

Colour:

- Black & White



GU10



LED PAR 16

5 W



38x29x23 cm / 24 pcs

Y

IP

20

LED NEW

JC069

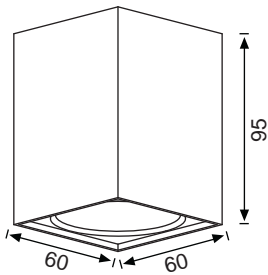
**Malzeme:**

- Alüminyum gövde
- Siyah renkli alüminyum reflektör
- Elektrostatik toz boyama

Material:

- Aluminium housing
- Aluminium reflector in black color
- Electrostatic powder coated

Renk:

- Beyaz & Siyah

Colour:

- Black & White



GU10



LED PAR 16

5 W



38x29x23 cm / 24 pcs

Y

IP

20

JC053



Malzeme:

- Alüminyum gövde
- Hareketli

Material:

- Aluminium housing
- Adjustable lamp position

Renk:

- Fırçalanmış Alüminyum

Colour:

- Brushed Aluminium

LED

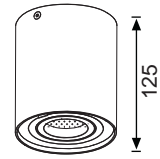

GU 10



LED Par 16

5 W



54.5x23x31 cm / 20 pcs

Y

IP

20

JC054



Malzeme:

- Alüminyum gövde
- Hareketli

Material:

- Aluminium housing
- Adjustable lamp position

Renk:

- Fırçalanmış Alüminyum

Colour:

- Brushed Aluminium

LED

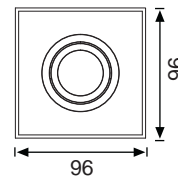
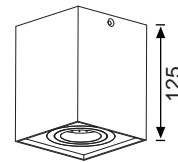

GU 10



LED Par 16

5 W



54.5x23x31 cm / 20 pcs

Y

IP

20

LED

JC045

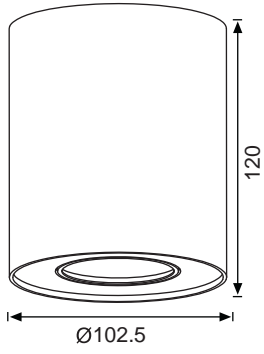

Malzeme:

- Alüminyum gövde
- Hareketli
- Elektrostatik toz boyama

Material:

- Aluminium housing
- Adjustable lamp position
- Electrostatic powder coated

Renk:

- Beyaz & Gümüş
- Gri

Colour:

- White & Silver
- Gray



GU 10



LED Par 16

5 W



54.5x23x27 cm / 20 pcs

Y

IP

20

LED

JC055

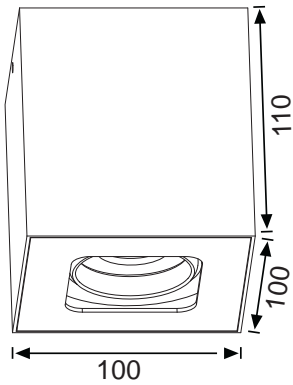

Malzeme:

- Alüminyum gövde
- Hareketli
- Elektrostatik toz boyama

Material:

- Aluminium housing
- Adjustable lamp position
- Electrostatic powder coated

Renk:

- Beyaz & Gümüş
- Gri

Colour:

- White & Silver
- Gray



GU 10



LED Par 16

5 W



54.5x23x27 cm / 20 pcs

Y

IP

20

JC060



Malzeme:

- Alüminyum gövde
- Elektrostatik toz boyama

Material:

- Aluminium housing
- Electrostatic powder coated

Renk:

- Mat Beyaz

Colour:

- Matt White

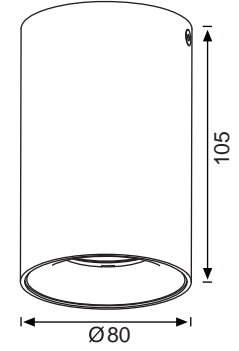

GU 10



LED Par 16

5 W



47x20x32 / 20 pcs

Y

IP

20

JC057



Malzeme:

- Alüminyum gövde
- Elektrostatik toz boyama

Material:

- Aluminium housing
- Electrostatic powder coated

Renk:

- Beyaz

Colour:

- White

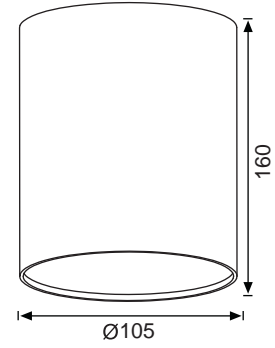

E 27



LED CLA 60

10 W



54.5x23x35 cm / 20 pcs

Y

IP

20

JC058



Malzeme:

- Alüminyum gövde
- Hareketli
- Elektrostatik toz boyama

Material:

- Aluminium housing
- Adjustable lamp position
- Electrostatic powder coated

Renk:

- Beyaz

Colour:

- White

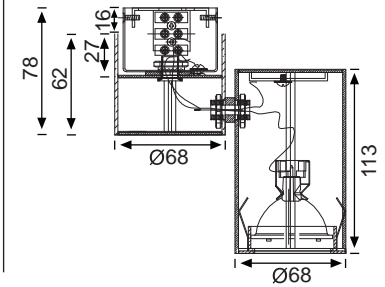

GU 10



LED Par 16

5 W



47x32x19 cm / 12 pcs

Y

IP

20

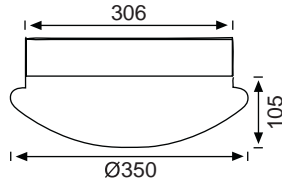
**Malzeme:**

- Alüminyum gövde
- Polikarbonat kapak
- Sensörlü
- Dahili LED sürücülü

Material:

- Aluminium housing
- Polycarbonate cover
- Built-in sensor
- Built-in LED driver

Renk:
• Beyaz**Colour:**
• White

LC440

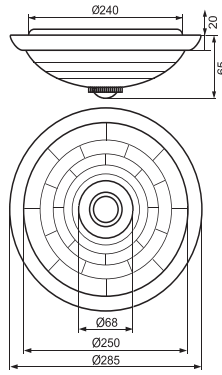

LED Tipi	Renk Sıcaklığı	Işık Akısı	Sistem Gücü	Voltaj	120°	75x40x41 / 6 pcs	Y	IP 20
SMD LED	3000 K	1150 lm	16 W	230V				

**Malzeme:**

- Alüminyum gövde
- Polikarbonat kapak
- Sensörlü
- Dahili LED sürücülü

Material:

- Aluminium housing
- Polycarbonate cover
- Built-in sensor
- Built-in LED driver

Renk:
• Beyaz**Colour:**
• White

LC441

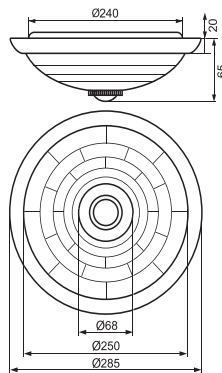

LED Tipi	Renk Sıcaklığı	Sistem Gücü	Voltaj	120°	83.5x31x61 / 20 pcs	Y	IP 20
SMD LED	4000 K	12 W	230V				

**Malzeme:**

- Alüminyum gövde
- Polikarbonat kapak
- Sensörlü
- Dahili LED sürücülü
- 3 saat acil durum ışıklı

Material:

- Aluminium housing
- Polycarbonate cover
- Built-in sensor
- Built-in LED driver
- 3 hours emergency lighting

Renk:
• Beyaz**Colour:**
• White

LC442



LED Tipi	Renk Sıcaklığı	Sistem Gücü	Voltaj	120°	83.5x31x61 / 20 pcs	Y	IP 20
SMD LED	4000 K	12 W	230V				

JC698



- Malzeme:**
- Metal gövde
 - Opal cam
 - Elektrostatik toz boyama

- Material:**
- Steel housing
 - Opal glass
 - Electrostatic powder coated

- Renk:**
- Mat Beyaz

- Colour:**
- Matt White

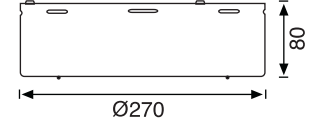

E 27

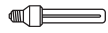

Dulux Star

2x20 W



57x29x36.5 cm / 8 pcs

Y

IP

20

JC762



- Malzeme:**
- Metal gövde
 - Krom çerçeve
 - Opal cam
 - Kaplama

- Material:**
- Steel housing
 - Chrome frame
 - Opal glass
 - Plated

- Renk:**
- Krom

- Colour:**
- Chrome

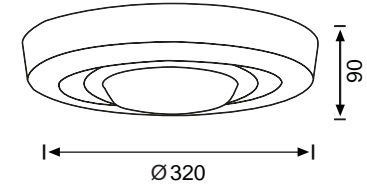

E 27



Spiral

2x20 W



37x37x20 cm / 1 pc

Y

IP

20

JC052



- Malzeme:**
- Metal Gövde
 - Akrilik difüzör
 - Kaplama

- Material:**
- Steel Housing
 - Acrylic Diffuser
 - Plated

- Renk:**
- Krom

- Colour:**
- Chrome

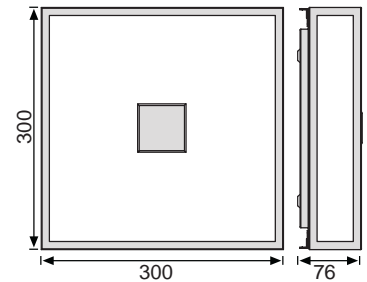

A+ electronic



E 27

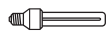

Dulux Star

2x20 W



71x52x36.5 cm / 8 pcs

Y

IP

44

e-electronic

JC043

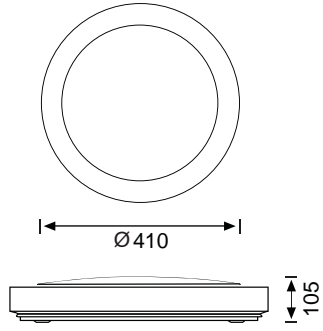
**Malzeme:**

- Metal gövde
- Paslanmaz çelik çerçeve
- Akriklik difüzör
- Dahili elektronik balast
- 4000 K ampüllü

Material:

- Steel housing
- Stainless steel frame
- Acrylic diffuser
- Built-in electronic ballast
- Supplied with 4000 K bulb

Renk:

- Krom

Colour:

- Chrome



2Gx13

T 5 FC

55 W

60x49x49 cm / 5 pcs

Y

IP

20

e-electronic

JC040

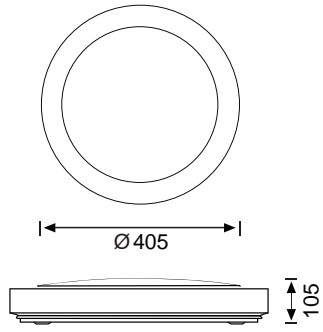
**Malzeme:**

- ABS gövde
- Polistren kapak
- Dahili elektronik balast
- 4000 K ampüllü

Material:

- ABS housing
- Polystyrene cover
- Built-in electronic ballast
- Supplied with 4000 K lamp

Renk:

- Beyaz
- Gümüş Gri

Colour:

- White
- Silver Gray



2Gx13

T5 FC

40 W

65x42x43 cm / 6 pcs

Y

IP

20

e-electronic

JC041

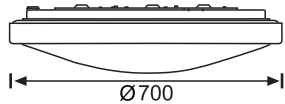
**Malzeme:**

- Metal gövde
- Polistren kapak
- Dahili elektronik balast
- 4000 K ampüllü

Material:

- Steel housing
- Polystyrene cover
- Built-in electronic ballast
- Supplied with 4000 K lamp

Renk:

- Beyaz

Colour:

- White



2G 11

Dulux L

3x36 W

79.5x74x80 cm / 3 pcs

Y

IP

20

LC480



Malzeme:

- Alüminyum enjeksiyon gövde
- Opal polikarbonat difüzör
- Elektrostatik toz boyama
- LED sürücülü

Material:

- Die-cast aluminium housing
- Opal polycarbonate diffuser
- Electrostatic powder coated
- With LED driver

Renk:

- Beyaz

Colour:

- White

LED

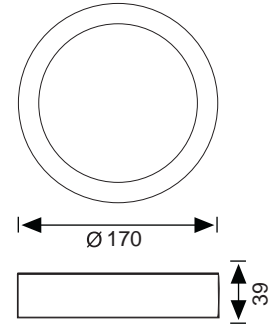

LED Tipi	Renk Sıcaklığı	Işık Akısı	Sistem Gücü	Voltaj		Y	IP
SMD 2835	3000 K / 6500 K	720 lm	12 W	230V	 37x25x37 cm / 20 pcs		20

LC453



Malzeme:

- Alüminyum enjeksiyon gövde
- Opal polikarbonat difüzör
- Elektrostatik toz boyama
- LED sürücülü

Material:

- Die-cast aluminium housing
- Opal polycarbonate diffuser
- Electrostatic powder coated
- With LED driver

Renk:

- Beyaz

Colour:

- White

LED

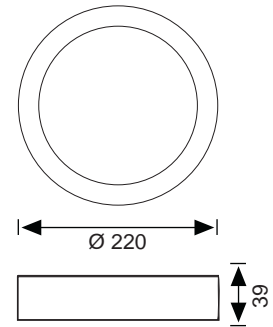

LED Tipi	Renk Sıcaklığı	Işık Akısı	Sistem Gücü	Voltaj		Y	IP
SMD 2835	3000 K / 6500 K	1100 lm	18 W	230V	 49x48x25 cm / 20 pcs		20

LC454



Malzeme:

- Alüminyum enjeksiyon gövde
- Opal polikarbonat difüzör
- Elektrostatik toz boyama
- LED sürücülü

Material:

- Die-cast aluminium housing
- Opal polycarbonate diffuser
- Electrostatic powder coated
- With LED driver

Renk:

- Beyaz

Colour:

- White

LED

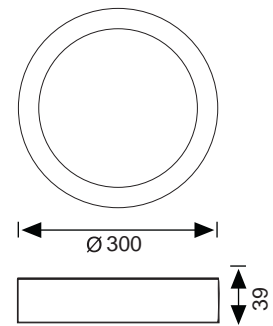

LED Tipi	Renk Sıcaklığı	Işık Akısı	Sistem Gücü	Voltaj		Y	IP
SMD 2835	3000 K / 6500 K	1440 lm	24 W	230V	 47x33x33 cm / 10 pcs		20

LED

LC481

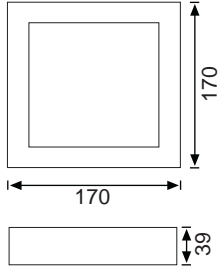
**Malzeme:**

- Alüminyum enjeksiyon gövde
- Opal polikarbonat difüzör
- Elektrostatik toz boyama
- LED sürücülü

Material:

- Die-cast aluminium housing
- Opal polycarbonate diffuser
- Electrostatic powder coated
- With LED driver

Renk:

- Beyaz

Colour:

- White



LED Tipi

Renk Sıcaklığı

Işık Akısı

Sistem Gücü

Voltaj

SMD 2835

3000 / 6500 K

720 lm

12 W

230V

 37x25x37 cm / 20 pcs

Y

IP
20

LED

LC455

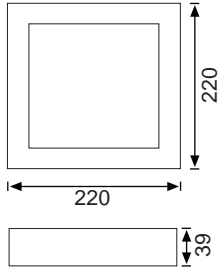
**Malzeme:**

- Alüminyum enjeksiyon gövde
- Opal polikarbonat difüzör
- Elektrostatik toz boyama
- LED sürücülü

Material:

- Die-cast aluminium housing
- Opal polycarbonate diffuser
- Electrostatic powder coated
- With LED driver

Renk:

- Beyaz

Colour:

- White



LED Tipi

Renk Sıcaklığı

Işık Akısı

Sistem Gücü

Voltaj

SMD 2835

3000 / 6500 K

1100 lm

18 W

230V

 49x48x25 cm / 20 pcs

Y

IP
20

LED

LC456

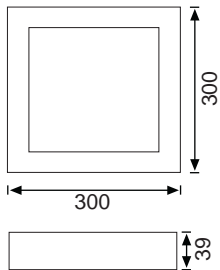
**Malzeme:**

- Alüminyum enjeksiyon gövde
- Opal polikarbonat difüzör
- Elektrostatik toz boyama
- LED sürücülü

Material:

- Die-cast aluminium housing
- Opal polycarbonate diffuser
- Electrostatic powder coated
- With LED driver

Renk:

- Beyaz

Colour:

- White



LED Tipi

Renk Sıcaklığı

Işık Akısı

Sistem Gücü

Voltaj

SMD 2835

3000 / 6500 K

1440 lm

24 W

230V

 47x33x33 cm / 10 pcs

Y

IP
20

LC437



Malzeme:

- Alüminyum enjeksiyon gövde
- Opal polikarbonat difüzör
- Elektrostatik toz boyama
- Dahili LED trafolu

Material:

- Die-cast aluminium housing
- Opal polycarbonate diffuser
- Electrostatic powder coated
- Built-in LED driver

Renk:

- Beyaz

Colour:

- White

EPistar inside

LED

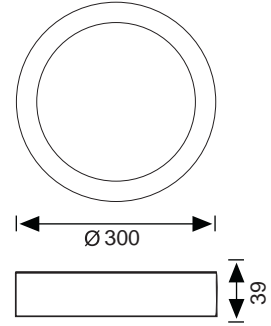

LED Tipi	Renk Sıcaklığı	Işık Akısı	Sistem Gücü	Voltaj		Y	IP
Epistar SMD LED	3000 / 6500 K	1850 / 2050 lm	24 W	230V	 50x32.5x33.5 cm / 10 pcs		20

LC438



Malzeme:

- Alüminyum enjeksiyon gövde
- Opal polikarbonat difüzör
- Elektrostatik toz boyama
- Dahili LED trafolu

Material:

- Die-cast aluminium housing
- Opal polycarbonate diffuser
- Electrostatic powder coated
- Built-in LED driver

Renk:

- Beyaz

Colour:

- White

EPistar inside

LED

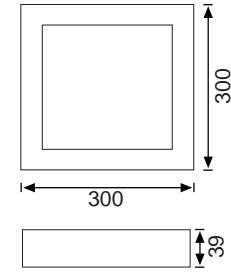

LED Tipi	Renk Sıcaklığı	Işık Akısı	Sistem Gücü	Voltaj		Y	IP
Epistar SMD LED	3000 / 6500 K	2200 / 2400 lm	24 W	230V	 50x32.5x33.5 cm / 10 pcs		20

LC458



Malzeme:

- Alüminyum enjeksiyon gövde
- Plastik çerçeve
- Opal polikarbonat difüzör
- Elektrostatik toz boyama
- Dahili LED trafolu

Material:

- Die-cast aluminium housing
- Plastic frame
- Opal polycarbonate diffuser
- Electrostatic powder coated
- Built-in LED driver

Renk:

- Beyaz

Colour:

- White

LED

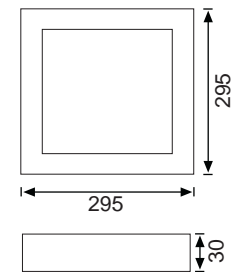

LED Tipi	Renk Sıcaklığı	Işık Akısı	Sistem Gücü	Voltaj		Y	IP
SMD LED	3000 K	950 lm	16 W	230V	 35x27x35 / 6 pcs		20

LED NEW

LE486

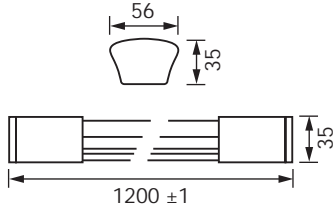
**Malzeme:**

- Plastik muhafazalı plastik gövde
- Dahili LED sürücülü

Renk:

- Beyaz

Material:

- Plastic housing with plastic cover
- Built-in LED driver

Colour:

- White

LED Tipi	Renk Sıcaklığı	Işık Akısı	Sistem Gücü	Voltaaj		Y	IP
SMD LED	3000 K / 6500 K	2300 lm	32 W	230 V	 127,5x27x23,5 cm / 20 pcs		65

LED NEW

LE487

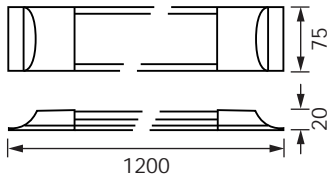
**Malzeme:**

- Plastik muhafazalı alüminyum gövde
- Dahili LED sürücülü

Renk:

- Beyaz

Material:

- Aluminium housing with plastic cover
- Built-in LED driver

Colour:

- White

LED Tipi	Renk Sıcaklığı	Işık Akısı	Sistem Gücü	Voltaaj		Y	IP
SMD LED	3000 K / 6500 K	2600 lm	36 W	230 V	 125,5x30,5x18 cm / 20 pcs		20

JE108
JE113
JE114
JE121
JE128

 A-electronic



Malzeme:

- Plastik muhafazalı, anahtarlı plastik gövde
- Dahili elektronik balast
- 1.5 m fişli kablolu
- Birbirine eklenebilir
- Besleme: 230 V/50 Hz
- 6500 K ampullü

Material:

- Plastic housing with plastic cover and switch
- Built-in electronic ballast
- 1.5 m power cord with plug
- Linkable
- Operating voltage: 230 V/50 Hz
- Supplied with 6500 K lamp

Renk:
• Beyaz

Colour:
• White

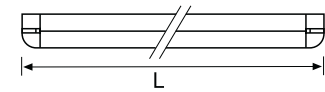

							
JE108	G 5	T 5	1x8 W	343 mm	37x42x21 cm / 30 pcs		
JE113	G 5	T 5	1x13 W	573 mm	58.5x42x21 cm / 30 pcs		
JE114	G 5	T 5	1x14 W	585 mm	63.5x42x21 cm / 30 pcs		
JE121	G 5	T 5	1x21 W	904 mm	92x33.5x18 cm / 20 pcs		
JE128	G 5	T 5	1x28 W	1204 mm	123x33.5x18 cm / 20 pcs		

JE208
JE213
JE214
JE221
JE228

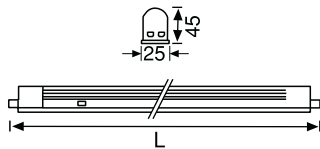
**Malzeme:**

- Plastik muhafazalı, anahtarlı alüminyum gövde
- Dahili elektronik balast
- 1.5 m fişli kablolu
- Birbirine eklenebilir
- Besleme: 230 V/50 Hz
- 6500 K ampullü

Material:



- Light-Weight aluminium housing with plastic cover and switch
- Built-in electronic ballast
- 1.5 m power cord with plug
- Linkable
- Operating voltage: 230 V/50 Hz
- Supplied with 6500 K lamp

Renk:

- Gümüş Gri

Colour:

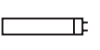
- Silver Gray

						Y	IP 20
JE208	G 5	T 5	1x8 W	341 mm	35.5x44.5x21 cm / 30 pcs		
JE213	G 5	T 5	1x13 W	571 mm	71x32x21 cm / 30 pcs		
JE214	G 5	T 5	1x14 W	583 mm	74x32x21 cm / 30 pcs		
JE221	G 5	T 5	1x21 W	903 mm	104x26x18 cm / 20 pcs		
JE228	G 5	T 5	1x28 W	1202 mm	133.5x26x17.5 cm / 20 pcs		

JE318

aj-electronic



Malzeme:

- Plastik muhafazalı, alüminyum gövde
- Dahili elektronik balast
- Besleme: 230 V/50 Hz
- 6500 K ampullü

Material:

- Light-Weight aluminium housing with plastic cover
- Built-in electronic ballast
- Operating voltage: 230 V/50 Hz
- Supplied with 6500 K lamp

Renk:
• Beyaz

Colour:
• White

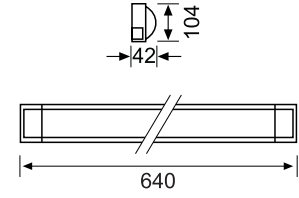

G 13



T 8

1x18 W



65.5x48x25 cm / 20 pcs

Y

IP

20

JE336

aj-electronic



Malzeme:

- Plastik muhafazalı, alüminyum gövde
- Dahili elektronik balast
- Besleme: 230 V/50 Hz
- 6500 K ampullü

Material:

- Light-Weight aluminium housing with plastic cover
- Built-in electronic ballast
- Operating voltage: 230 V/50 Hz
- Supplied with 6500 K lamp

Renk:
• Beyaz

Colour:
• White

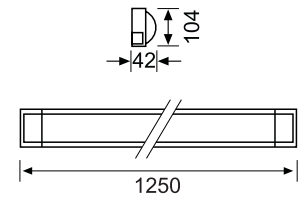

G 13



T 8

1x36 W



127x36x20.5 cm / 12 pcs

Y

IP

20

**Malzeme:**

- Plastik muhafazalı, alüminyum gövde
- Dahili elektronik balast
- Besleme: 230 V/50 Hz
- 6500 K ampullü

Material:

- Light-Weight aluminium housing with plastic cover
- Built-in electronic ballast
- Operating voltage: 230 V/50 Hz
- Supplied with 6500 K lamp

Renk:

- Beyaz

Colour:

- White

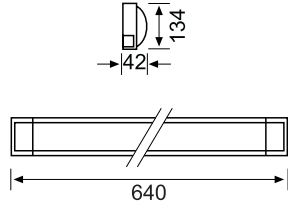

G 13



T 8

2x18 W



65.5x43.5x22 cm / 12 pcs

Y

IP
20**Malzeme:**

- Plastik muhafazalı, alüminyum gövde
- Dahili elektronik balast
- Besleme: 230 V/50 Hz
- 6500 K ampullü

Material:

- Light-Weight aluminium housing with plastic cover
- Built-in electronic ballast
- Operating voltage: 230 V/50 Hz
- Supplied with 6500 K lamp

Renk:

- Beyaz

Colour:

- White

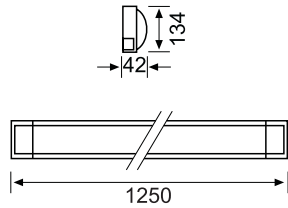

G 13



T 8

2x36 W



126.5x43.5x22 cm / 12 pcs

Y

IP
20

JE118
JE136



- Malzeme:**
- Plastik muhafazalı, anahtarlı, alüminyum gövde
 - Dahili elektronik balast
 - Besleme: 230 V/50 Hz
 - 6500 K ampullü

- Material:**
- Light-Weight aluminium housing with plastic cover and switch
 - Built-in electronic ballast
 - Operating voltage: 230 V/50 Hz
 - Supplied with 6500 K lamp

- Renk:**
- Beyaz

- Colour:**
- White

aelectronic

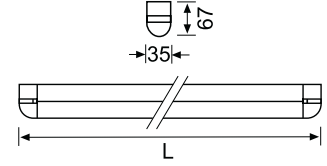

Kod			L		Y	IP
JE118	G 13	T 8	1x18 W	670 mm	68.5x36x20 cm / 20 pcs	20
JE136	G 13	T 8	1x36 W	1280 mm	129.5x22x20 cm / 12 pcs	

JE508
JE513



- Malzeme:**
- Plastik muhafazalı, anahtarlı, plastik gövde
 - Dahili elektronik balast
 - 1.5 m fişli kablolu
 - Besleme: 230 V/50 Hz
 - 6500 K ampullü

- Material:**
- Plastic housing with plastic cover and switch
 - Built-in electronic ballast
 - 1.5 m power cord with plug
 - Operating voltage: 230 V/50 Hz
 - Supplied with 6500 K lamp

- Renk:**
- Beyaz

- Colour:**
- White

aelectronic

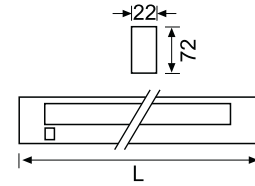

Kod			L		Y	IP
JE508	G 5	T 5	1x8 W	346 mm	36x24x32 cm / 20 pcs	20
JE513	G 5	T 5	1x13 W	578 mm	57x24x32 cm / 20 pcs	

JE218



- Malzeme:**
- Plastik muhafazalı, anahtarlı, prizli alüminyum gövde
 - Dahili elektronik balast
 - Besleme: 230 V/50 Hz
 - 6500 K ampullü

- Material:**
- Light-weight aluminium housing with plastic cover, switch and sockets
 - Built-in electronic ballast
 - Operating voltage: 230 V/50 Hz
 - Supplied with 6500 K lamp

- Renk:**
- Beyaz

- Colour:**
- White

aelectronic

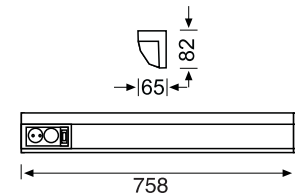

		L		Y	IP
G 13	T 8	1x18 W	78x28x30.5 cm / 12 pcs		20

LED

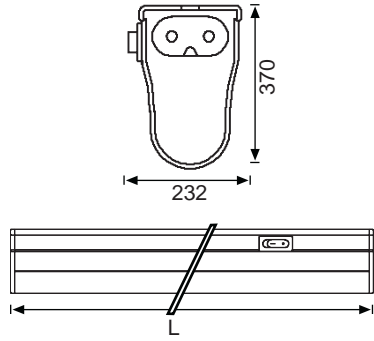
**Malzeme:**

- Plastik muhafazalı, anahtarlı plastik gövde
- 1.8 m fişli kablolu
- Birbirine eklenebilir
- Dahili LED sürücülü

Material:

- Plastic housing with plastic cover and switch
- 1.8 m power cord with plug
- Linkable
- Built-in LED driver

Renk:
• Beyaz**Colour:**
• WhiteLE108
LE121
LE128

Kod	LED Tipi	Renk Sıcaklığı	Işık Akısı	Sistem Gücü	Voltaj	L		Y	IP
LE108	SMD LED	3000 K	410 lm	4.8 W	230V	296 mm	40x32x21 cm / 30 pcs		20
LE121	SMD LED	3000 K	1000 lm	12 W	230V	904 mm	92x40x21 cm / 30 pcs		
LE128	SMD LED	3000 K	1370 lm	16.2 W	230V	1157 mm	58.5x42x21 cm / 30 pcs		

LED

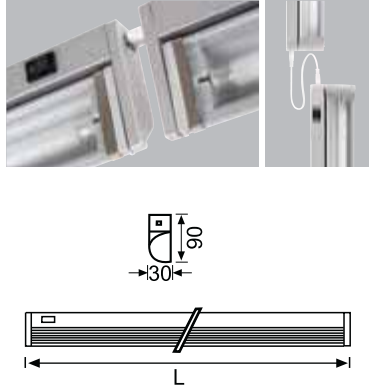
**Malzeme:**

- Cam muhafazalı, anahtarlı alüminyum gövde
- 1.8 m fişli kablolu
- Birbirine eklenebilir
- Dahili LED sürücülü

Material:

- Light-Weight aluminium housing with glass cover and switch
- 1.8 m power cord with plug
- Linkable
- Built-in LED driver

Renk:
• Gümüş Gri**Colour:**
• Silver GrayLE421
LE428

Kod	LED Tipi	Renk Sıcaklığı	Işık Akısı	Sistem Gücü	Voltaj	L		Y	IP
LE421	SMD LED	3000 K	1000 lm	12 W	230V	890 mm	60x40x21.5 cm / 20 pcs		20
LE428	SMD LED	3000 K	1370 lm	16.2 W	230V	1191 mm	60x40x21.5 cm / 20 pcs		

electronic

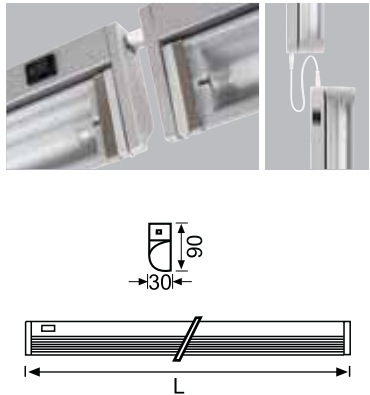
**Malzeme:**

- Cam muhafazalı, anahtarlı alüminyum gövde
- Dahili elektronik balast
- 1.5 m fişli kablolu
- Birbirine eklenebilir
- Besleme: 230 V/50 Hz
- 6500 K ampullü

Material:

- Light-Weight aluminium housing with glass cover and switch
- Built-in electronic ballast
- 1.5 m power cord with plug
- Linkable
- Operating voltage: 230 V/50 Hz
- Supplied with 6500 K lamp

Renk:
• Gümüş Gri**Colour:**
• Silver Gray

JE408

Kod			L		Y	IP
JE408	G 5	T 5	1x8 W	350 mm	40x37x25 cm / 20 pcs	20

LE494
LE495
LE496
LE497



Malzeme:

- Plastik muhafazalı plastik gövde
- Birbirine eklenebilir
- Dahili sürücülü

Material:

- Plastic housing with plastic cover
- Linkable
- Built-in driver

Renk:

- Beyaz

Colour:

- White

NEW LED

Birleşme yerinde karanlık gölge olmadan devamlı ışık

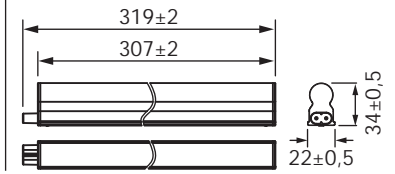

Kod	LED Tipi	Renk Sıcaklığı	Işık Akısı	Sistem Gücü	Voltaj	L	Y	IP
LE494	SMD LED	3000 K/6500 K	320 lm	4 W	230 V	319 mm	45x20x15 cm / 25 pcs	20
LE495	SMD LED	3000 K/6500 K	560 lm	7 W	230 V	580 mm	71x20x15 cm / 25 pcs	
LE496	SMD LED	3000 K/6500 K	960 lm	12 W	230 V	880 mm	101x20x15 cm / 25 pcs	
LE497	SMD LED	3000 K/6500 K	1260 lm	14 W	230 V	1180 mm	131x20x15 cm / 25 pcs	

LE030
LE060
LE090
LE120



Malzeme:

- Plastik muhafazalı alüminyum gövde
- Birbirine eklenebilir
- Dahili LED sürücülü
- Anahtarlı

Material:

- Aluminium housing with plastic cover
- Linkable
- Built-in LED driver
- Built-in switch

Renk:

- Alüminyum

Colour:

- Aluminium

Birbirine Ekleme Adedi:

- LE030 = 16 Ad.
- LE060 = 10 Ad.
- LE090 = 7 Ad.
- LE120 = 5 Ad.

Maximum possible links:

- LE030 = 16 pcs
- LE060 = 10 pcs
- LE090 = 7 pcs
- LE120 = 5 pcs

LED

Birleşme yerinde karanlık gölge olmadan devamlı ışık

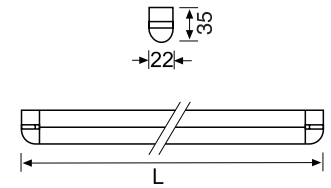

Kod	LED Tipi	Renk Sıcaklığı	Işık Akısı	Sistem Gücü	Voltaj	L	Y	IP
LE030	SMD LED	3000 K/6500 K	320 lm	4.5 W	230V	300 mm	45x20x15 cm / 25 pcs	20
LE060	SMD LED	3000 K/6500 K	560 lm	7.5 W	230V	600 mm	71x20x15 cm / 25 pcs	
LE090	SMD LED	3000 K/6500 K	800 lm	11.5 W	230V	900 mm	191x20x15 cm / 25 pcs	
LE120	SMD LED	3000 K/6500 K	1120 lm	14.5 W	230V	1200 mm	131x20x15 cm / 25 pcs	

LED

LE498



Birleşme yerinde karanlık gölge olmadan devamlı ışık

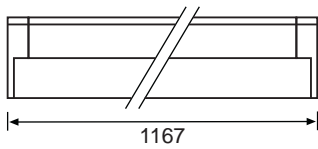
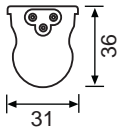

Malzeme:

- Alüminyum gövde
- Elektrostatik toz boyama
- Opal polikarbonat difüzör
- Dahili LED sürücülü

Material:

- Aluminium housing
- Electrostatic powder coated
- Opal polycarbonate diffuser
- Built-in LED driver

Renk:

- Beyaz

Colour:

- White

LED Tipi	Renk Sıcaklığı	Işık Akısı	Sistem Gücü	Voltaj		Y	IP
SMD LED	3000 K / 6500 K	1600 lm	18 W	230V	129.6x18x18 cm / 25 pcs		20



LE220

LE210

LED NEW



Renk:

- 3000 K
- 6500 K
- Kırmızı
- Mavi
- Yeşil

Colour:

- 3000 K
- 6500 K
- Red
- Blue
- Green

Malzeme:

- 220 V Şerit LED
- 60 adet 5050 SMD/m
- 14x7 mm boyut

Material:

- 220 V LED Strip
- 60 pcs 5050 SMD/m
- Size 14x7 mm



220 V Güç Kablosu Pin Uç Parçası
Bağlantı Parçası Montaj Parçası Vida

LED Tipi	Işık Akısı	Sistem Gücü	Voltaj	120°	33x33x14 cm / 50 m	IP 67
SMD LED	1560 lm/m	9 W/m	220V			

LED NEW

LE220



Renk:

- 3000 K
- 6500 K
- Kırmızı
- Mavi
- Yeşil

Colour:

- 3000 K
- 6500 K
- Red
- Blue
- Green

Malzeme:

- 220 V Neon Şerit LED
- Tek yönlü
- 120 adet 2835 SMD/m
- 14x7 mm boyut

Material:

- 220 V Neon LED Strip
- Single sided
- 120 pcs 2835 SMD/m
- Size 14x7 mm



220 V Güç Kablosu Pin Uç Parçası
Bağlantı Parçası Montaj Parçası Vida

LED Tipi	Işık Akısı	Sistem Gücü	Voltaj	34x34x18,5 cm / 50 m	IP 68
SMD LED	3120 lm/m	9 W/m	220V		

LE209



Malzeme:

- Üç çipli iç mekan için şerit LED

Material:

- Three chip LED strip for indoors

Renk:

- 3000 K
- 4000 K
- 6500 K

Colour:

- 3000 K
- 4000 K
- 6500 K

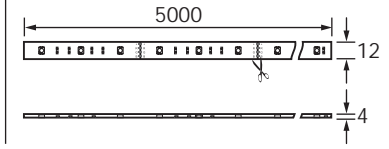

LED Tipi	Renk Sıcaklığı	Işık Akısı	Sistem Gücü	Voltaj	42x26x22 cm / 2x5 m (200m)	IP 20
SMD LED	3000 K	1560 lm/m	14,4 W/m	DC 12V		

LE219



Malzeme:

- Üç çipli dış mekan için şerit LED

Material:

- Three chip LED strip for outdoors

Renk:

- 3000 K
- 4000 K
- 6500 K

Colour:

- 3000 K
- 4000 K
- 6500 K

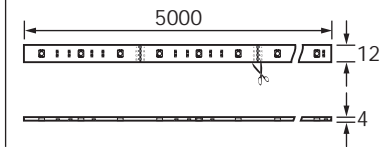

LED Tipi	Renk Sıcaklığı	Işık Akısı	Sistem Gücü	Voltaj	38x22x20 cm / 2x5 m (200m)	IP 44
SMD LED	3000 K	1560 lm/m	14,4 W/m	DC 12V		

LED

LE208

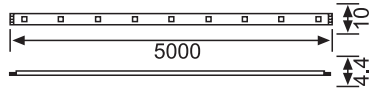
**Malzeme:**

- Üç çipli iç mekan için şerit LED

Material:

- Three chip LED strip for indoors

IP
20

Kod Code	K	Max W/M	V	Lm/M	Işık Açısı Beam Angle	Led/M	IP	Kutu Adedi Quantity Per Carton	Kutu Ölçüleri Packaging Meas. (cm)
LE208 B	6500	12	DC 12	960	140°	60 SMD 5050	20	2x5 M	34x26x23.5/200 M
LE208 S	3000	12	DC 12	940	140°	60 SMD 5050	20	2x5 M	34x26x23.5/200 M
LE208 M	Mavi/Blue	12	DC 12	-	140°	60 SMD 5050	20	2x5 M	34x26x23.5/200 M

LED

LE218

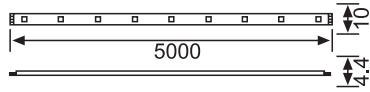
**Malzeme:**

- Üç çipli dış mekan için şerit LED

Material:

- Three chip LED strip for outdoors

IP
44

Kod Code	K	Max W/M	V	Lm/M	Işık Açısı Beam Angle	Led/M	IP	Kutu Adedi Quantity Per Carton	Kutu Ölçüleri Packaging Meas. (cm)
LE218 B	6500	12	DC 12	960	140°	60 SMD 5050	44	5 M	34x26x23.5/100 M
LE218 S	3000	12	DC 12	940	140°	60 SMD 5050	44	5 M	34x26x23.5/100 M
LE218 M	Mavi/Blue	12	DC 12	-	140°	60 SMD 5050	44	5 M	34x26x23.5/100 M



JH638 B



JH638 K



JH638 SN



JH639 B



JH639 K



JH639 SN

JD228



Malzeme:

- Metal gövde
- Alüminyum enjeksiyon çerçeve
- Hareketli
- Elektrostatik toz boyama

Material:

- Steel housing
- Die-cast aluminium frame
- Adjustable lamp position
- Electrostatic powder coated

Renk:

- Beyaz

Colour:

- White

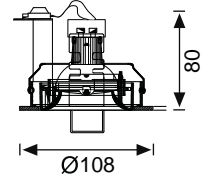

GU 10



LED Par 16

5 W



Ø100 mm



36.5x36.5x34 cm / 36 pcs



IP 20

JD229



Malzeme:

- Metal gövde
- Alüminyum enjeksiyon çerçeve
- Hareketli
- Elektrostatik toz boyama

Material:

- Steel housing
- Die-cast aluminium frame
- Adjustable lamp position
- Electrostatic powder coated

Renk:

- Beyaz

Colour:

- White

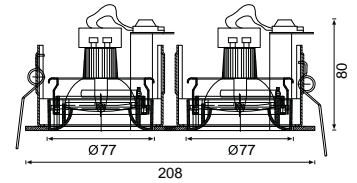

GU 10



LED Par 16

2x5 W



200x95 mm



36.5x23.5x34 cm / 12 pcs



IP 20

JD230

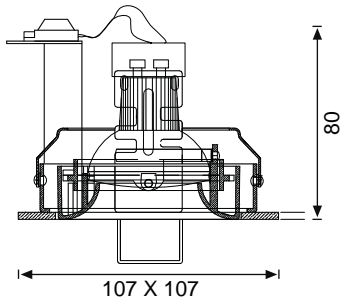
**Malzeme:**

- Metal gövde
- Alüminyum enjeksiyon çerçeve
- Hareketli
- Elektrostatik toz boyama

Material:

- Steel housing
- Die-cast aluminium frame
- Adjustable lamp position
- Electrostatic powder coated

Renk:

- Beyaz

Colour:

- White



GU 10



LED Par 16

5 W



Ø100 mm



36.5x36.5x34 cm / 36 pcs



IP 20

JD231

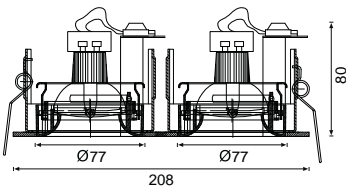
**Malzeme:**

- Metal gövde
- Alüminyum enjeksiyon çerçeve
- Hareketli
- Elektrostatik toz boyama

Material:

- Steel housing
- Die-cast aluminium frame
- Adjustable lamp position
- Electrostatic powder coated

Renk:

- Beyaz

Colour:

- White



GU 10



LED Par 16

2x5 W



200x95 mm



36.5x23.5x34 cm / 12 pcs



IP 20

JD233



- Malzeme:**
- Alüminyum enjeksiyon gövde
 - Elektrostatik toz boyama

- Material:**
- Die-cast aluminium housing
 - Electrostatic powder coated

- Renk:**
- Mat Beyaz

- Colour:**
- Matt White

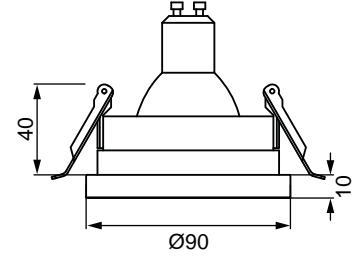

GU 10



LED Par 16

5 W



Ø80 mm

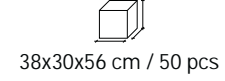

38x30x56 cm / 50 pcs



Y



IP

20

JD640



- Malzeme:**
- Alüminyum gövde
 - Elektrostatik toz boyama

- Material:**
- Aluminium housing
 - Electrostatic powder coated

- Renk:**
- Altın
 - Beyaz

- Colour:**
- Gold
 - White

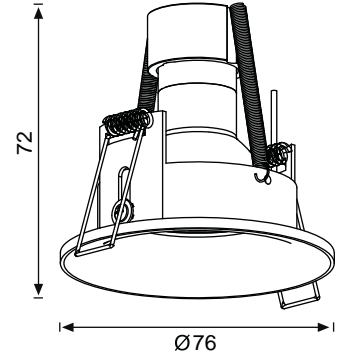

GU 10



LED Par 16

5 W



Ø65 mm

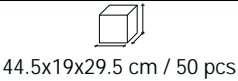

44.5x19x29.5 cm / 50 pcs



Y



IP

20

JH684



- Malzeme:**
- Alüminyum gövde
 - Çok yönlü hareketli
 - Elektrostatik toz boyama
 - Ampülü önden değiştirilebilir

- Material:**
- Aluminium housing
 - Multi-directional adjustable lamp position
 - Electrostatic powder coated
 - Bulb replaceable without dismantling

- Renk:**
- Mat Beyaz

- Colour:**
- Matt White

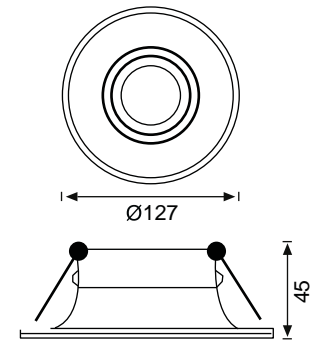

GU 10



LED Par 16

5 W



Ø105 mm

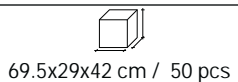

69.5x29x42 cm / 50 pcs



Y



IP

20

JH659

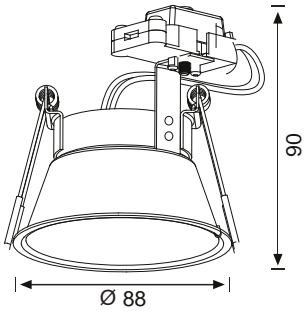
**Malzeme:**

- Alüminyum gövde
- Elektrostatik toz boyama

Material:

- Aluminium housing
- Electrostatic powder coated

Renk:

- Mat Beyaz
- Mat Siyah

Colour:

- Matt White
- Matt Black



GU 10



LED Par 16

5 W



Ø80 mm



52x21.5x52 cm / 50 pcs

Y

IP

20

JH688

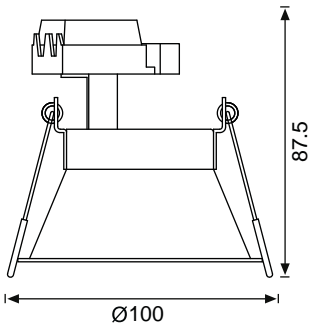
**Malzeme:**

- Alüminyum gövde
- Elektrostatik toz boyama

Material:

- Aluminium housing
- Electrostatic powder coated

Renk:

- Mat Beyaz

Colour:

- Matt White



GU 10



LED Par 16

5 W



Ø92 mm



52x24x54.5 cm / 50 pcs

Y

IP

20

JH660

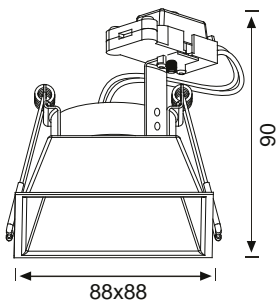
**Malzeme:**

- Alüminyum gövde
- Elektrostatik toz boyama

Material:

- Aluminium housing
- Electrostatic powder coated

Renk:

- Mat Beyaz

Colour:

- Matt White



GU 10



LED Par 16

5 W



80x80 mm



52x21.5x52 cm / 50 pcs

Y

IP

20

JH671



- Malzeme:**
- Metal gövde
 - Yönlendirilebilir ampul
 - Elektrostatik toz boyama

- Material:**
- Steel housing
 - Adjustable lamp position
 - Electrostatic powder coated

- Renk:**
- Beyaz
 - Siyah
 - Gümüş Gri

- Colour:**
- White
 - Black
 - Silver Gray

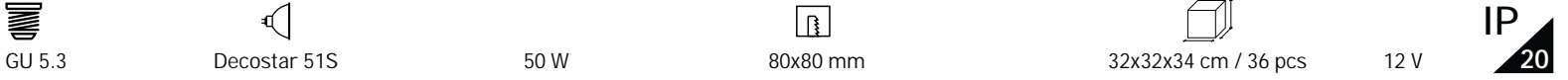
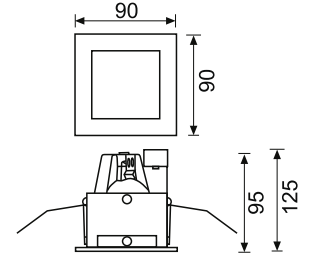

JD232



- Malzeme:**
- Metal gövde
 - Yönlendirilebilir ampul
 - Elektrostatik toz boyama

- Material:**
- Steel housing
 - Adjustable lamp position
 - Electrostatic powder coated

- Renk:**
- Beyaz
 - Siyah
 - Gümüş Gri

- Colour:**
- White
 - Black
 - Silver Gray

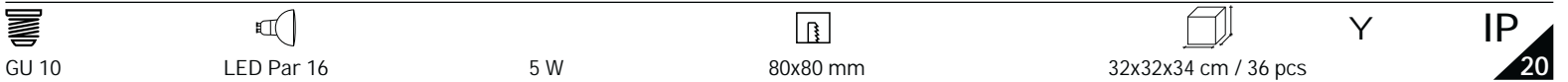
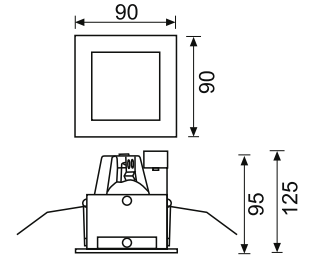

JD634



- Malzeme:**
- Alüminyum enjeksiyon gövde
 - Elektrostatik toz boyama

- Material:**
- Die-cast aluminium housing
 - Electrostatic powder coated

- Renk:**
- Beyaz
 - Siyah

- Colour:**
- White
 - Black

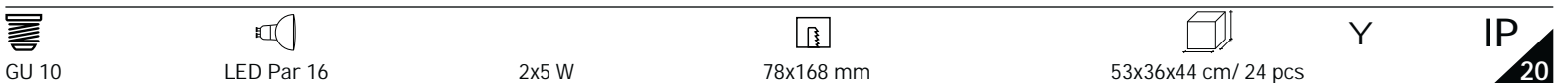
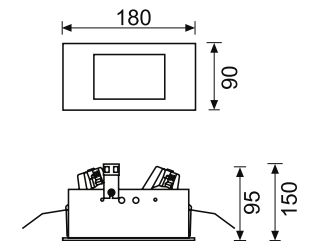

JH603

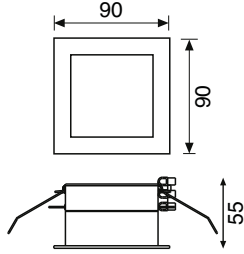
**Malzeme:**

- Zamak gövde
- Çok yönlü hareketli
- Elektrostatik toz boyama

Material:

- Die-cast zinc housing
- Multi-directional adjustable lamp position
- Electrostatic powder coated

Renk:

- Mat Beyaz
- Saten Nikel

Colour:

- Matt White
- Satin Nickel



GU 5.3



Decostar 51S

50 W



80x80 mm



65x43.5x48.5 cm / 50 pcs

12 V

IP

20

JH639

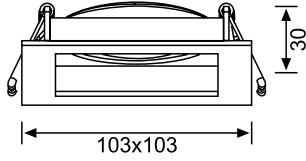
**Malzeme:**

- Zamak gövde
- Çok yönlü hareketli
- Elektrostatik toz boyama veya kaplama

Material:

- Die-cast zinc housing
- Multi-directional adjustable lamp position
- Electrostatic powder coated or plated

Renk:

- Beyaz
- Krom
- Saten Nikel

Colour:

- White
- Chrome
- Satin Nickel



GU 5.3



Decostar 51S

50 W



90x90 mm



62x25x27.5cm / 50 pcs

12 V

IP

20

JH638

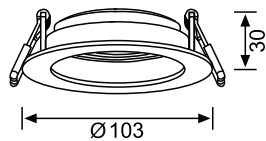
**Malzeme:**

- Zamak gövde
- Çok yönlü hareketli
- Elektrostatik toz boyama veya kaplama

Material:

- Die-cast zinc housing
- Multi-directional adjustable lamp position
- Electrostatic powder coated or plated

Renk:

- Beyaz
- Krom
- Saten Nikel

Colour:

- White
- Chrome
- Satin Nickel



GU 5.3



Decostar 51S

50 W



Ø90 mm



57x23x29 cm / 50 pcs

12 V

IP

20

JH624



Malzeme:

- Alüminyum gövde
- Buzlu cam
- Kaplama

Material:

- Aluminium housing
- Frosted glass
- Plated

Renk:

- Krom

Colour:

- Chrome

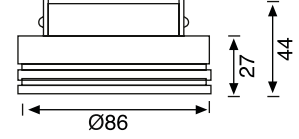

GU 5.3



Decostar 51S

50 W



Ø68 mm



57x24x32 cm / 50 pcs

12 V

IP

44

JH618



Malzeme:

- Zamak gövde
- Buzlu cam
- Kaplama
- Ampulü önden değiştirilebilir

Material:

- Die-cast zinc housing
- Frosted glass
- Plated
- Bulb replaceable without dismounting

Renk:

- Saten Nikel & Krom

Colour:

- Satin Nickel & Chrome

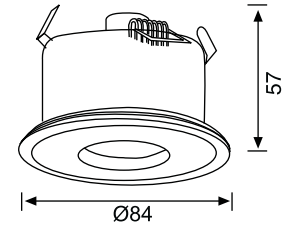

GU 5.3



Decostar 51S

50 W



Ø74 mm



47x20x37.5 cm / 50 pcs

12 V

IP

65

JH515



Malzeme:

- Alüminyum enjeksiyon gövde
- Buzlu cam
- Elektrostatik toz boyama veya kaplama
- Ampulü önden değiştirilebilir

Material:

- Die-cast aluminium housing
- Frosted glass
- Electrostatic powder coated or plated
- Bulb replaceable without dismounting

Renk:

- Krom
- Beyaz

Colour:

- Chrome
- White

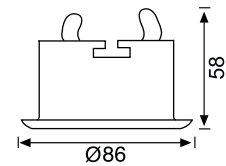

GU 5.3



Decostar 51S

50 W



Ø72 mm



47x30x58 cm / 50 pcs

12 V

IP

65

LED

EPISTAR inside

LS453

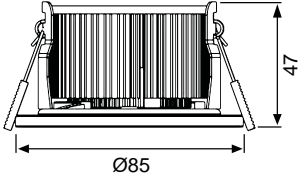
**Malzeme:**

- Alüminyum enjeksiyon gövde
- Kaplama
- LED sürücülü

Material:

- Die-cast aluminium housing
- Plated
- With LED driver

Renk:

- Krom

Colour:

- Chrome



LED Tipi	Renk Sıcaklığı	Işık Akısı	Sistem Gücü	Voltaj	Ø75 mm	51x21x52 cm / 50 pcs	Y	IP 65
Epistar COB	3000 K	480 lm	6 W	230V				

JH680

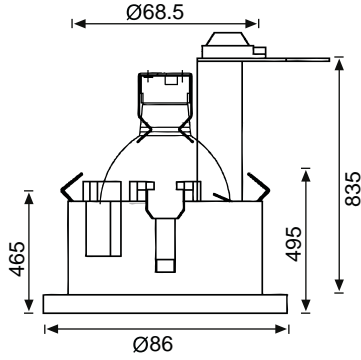
**Malzeme:**

- Alüminyum enjeksiyon gövde
- Zamak çerçeve
- Isıya dayanıklı cam
- Elektrostatik toz boyama
- Ampülü önden değiştirilebilir

Material:

- Die-cast aluminium housing
- Die-cast zinc frame
- Tempered glass
- Electrostatic powder coated
- Bulb replaceable without dismounting

Renk:

- Beyaz

Colour:

- White



GU 5.3	Decostar 51S	50 W	Ø73 mm	32x32x34 cm / 36 pcs	12 V	IP 65
--------	--------------	------	--------	----------------------	------	-------

LED

LS455

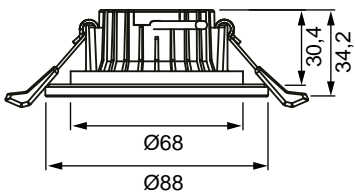
**Malzeme:**

- Plastik gövde
- Dahili LED sürücülü

Material:

- Plastic housing
- Built-in LED driver

Renk:

- Beyaz

Colour:

- White



LED Tipi	Renk Sıcaklığı	Işık Akısı	Sistem Gücü	Voltaj	Ø60 mm	120	62x49x23.5 cm / 100 pcs	Y	IP 65
SMD LED	3000 K	400 lm	5 W	230V					

JH710



Malzeme:
• Metal gövde
• Plastik halka

Material:
• Metal housing
• Plastic ring

Renk:
• Beyaz & Siyah

Colour:
• White & Black

NEW

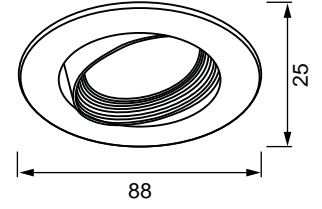

		5 W			Y	IP
GU10	LED Par 16		Ø75 mm	47,5x38,5x22 cm / 100 pcs		20

JH509



Malzeme:
• Zamak gövde
• Elektrostatik toz boyama veya kaplama

Material:
• Die-cast zinc housing
• Electrostatic powder coated or plated

Renk:
• Beyaz
• Krom
• Mat Krom
• Altın
• Saten Nikel

Colour:
• White
• Chrome
• Matt Chrome
• Gold
• Satin Nickel

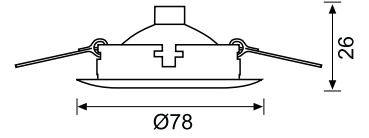

		50 W			12 V	IP
GU 5.3	Decostar 51S		Ø60 mm	45x19x32 cm / 100 pcs	12 V	20

JH510



Malzeme:
• Zamak gövde
• Hareketli
• Elektrostatik toz boyama veya kaplama

Material:
• Die-cast zinc housing
• Adjustable lamp position
• Electrostatic powder coated or plated

Renk:
• Beyaz
• Krom
• Mat Krom
• Altın
• Saten Nikel

Colour:
• White
• Chrome
• Matt Chrome
• Gold
• Satin Nickel

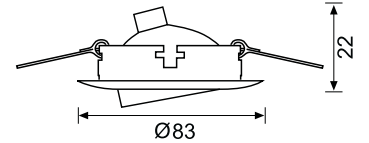

		50 W			12 V	IP
GU 5.3	Decostar 51S		Ø70 mm	45x19x27.5 cm / 100 pcs	12 V	20

JH516



Malzeme:
• Zamak gövde
• Prizmatik cam
• Elektrostatik toz boyama veya kaplama

Material:
• Die-cast zinc housing
• Prismatic glass
• Electrostatic powder coated or plated

Renk:
• Beyaz
• Krom

Colour:
• White
• Chrome

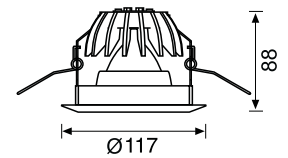

		50 W			12 V	IP
GU 5.3	Decostar 51S		Ø107 mm	58x24x57 cm / 50 pcs	12 V	20

JH627

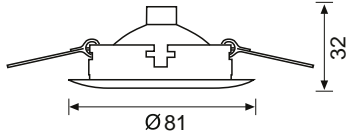
**Malzeme:**

- Zamak gövde
- Elektrostatik toz boyama
- Önden ampul değiştirme

Material:

- Die-cast zinc housing
- Electrostatic powder coated
- Frontal bulb replacement

Renk:

- Beyaz

Colour:

- White



GU 5.3



Decostar 51S

50 W



Ø68 mm



45x18x25 cm / 50 pcs

12 V

IP
20

JH628

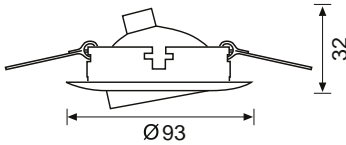
**Malzeme:**

- Zamak gövde
- Elektrostatik toz boyama
- Önden ampul değiştirme
- Hareketli

Material:

- Die-cast zinc housing
- Electrostatic powder coated
- Frontal bulb replacement
- Adjustable lamp position

Renk:

- Beyaz

Colour:

- White



GU 5.3



Decostar 51S

50 W



Ø80 mm



53x22x25 cm / 50 pcs

12 V

IP
20

JH541

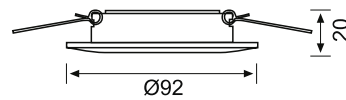
**Malzeme:**

- Zamak gövde
- Hareketli
- Kaplama

Material:

- Die-cast zinc housing
- Adjustable lamp position
- Plated

Renk:

- Krom & İncili Krom

Colour:

- Chrome & Pearly Chrome



GU 5.3



Decostar 51S

50 W



Ø75 mm



52x21.5x27.5 cm / 50 pcs

12 V

IP
20

JH521

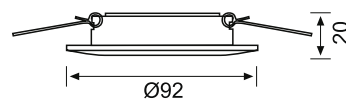
**Malzeme:**

- Zamak gövde
- Hareketli
- Kaplama

Material:

- Die-cast zinc housing
- Adjustable lamp position
- Plated

Renk:

- Gümüş & İncili Altın

Colour:

- Silver & Pearly Gold



GU 5.3



Decostar 51S

50 W



Ø75 mm



52x21.5x27.5 cm / 50 pcs

12 V

IP
20

JH619



- Malzeme:**
- Zamak gövde
 - Hareketli
 - Önden ampul değiştirme
 - Kaplama

- Material:**
- Die-cast zinc housing
 - Adjustable lamp position
 - Frontal bulb replacement
 - Plated

- Renk:**
- Saten Nikel

- Colour:**
- Satin Nickel

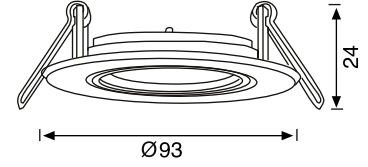

 GU 5.3	 Decostar 51S	50 W	 Ø80 mm	 52x21.5x28 cm / 50 pcs	12 V	IP 20
--	--	------	--	--	------	------------------------

JH564



- Malzeme:**
- Zamak gövde
 - Hareketli
 - Önden ampul değiştirme
 - Kaplama

- Material:**
- Die-cast zinc housing
 - Adjustable lamp position
 - Frontal bulb replacement
 - Plated

- Renk:**
- Saten Nikel

- Colour:**
- Satin Nickel

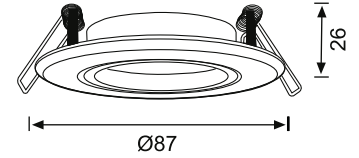

 GU 5.3	 Decostar 51S	50 W	 Ø77 mm	 47x20x28 cm / 50 pcs	12 V	IP 20
--	--	------	--	--	------	------------------------

JH650



- Malzeme:**
- Zamak gövde
 - Alüminyum reflektör
 - Kaplama

- Material:**
- Die-cast zinc housing
 - Aluminium reflector
 - Plated

- Renk:**
- Krom

- Colour:**
- Chrome

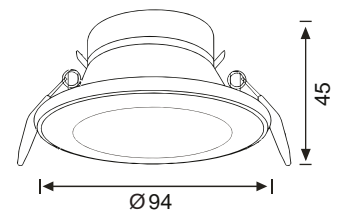

 GU 5.3	 Decostar 51S	50 W	 Ø85 mm	 51x21x35 cm / 50 pcs	12 V	IP 20
--	--	------	--	--	------	------------------------

JH620

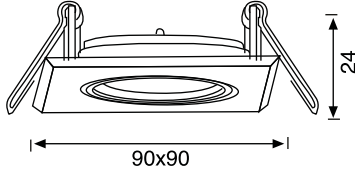
**Malzeme:**

- Zamak gövde
- Hareketli
- Önden ampul değiştirme
- Kaplama

Material:

- Die-cast zinc housing
- Adjustable lamp position
- Frontal bulb replacement
- Plated

Renk:

- Saten Nikel

Colour:

- Satin Nickel



GU 5.3



Decostar 51S

50 W



Ø80 mm



52x21.5x28 cm / 50 pcs

12 V

IP

20

JH565

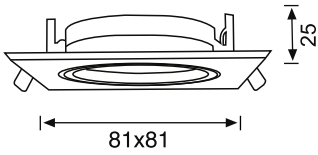
**Malzeme:**

- Zamak gövde
- Hareketli
- Kaplama

Material:

- Die-cast zinc housing
- Adjustable lamp position
- Plated

Renk:

- Saten Nikel

Colour:

- Satin Nickel



GU 5.3



Decostar 51S

50 W



Ø70 mm



46x36x29 cm / 100 pcs

12 V

IP

20

JH697

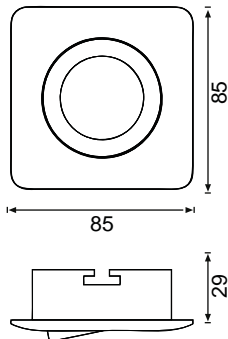
**Malzeme:**

- Alüminyum gövde
- Hareketli
- Kaplama

Material:

- Aluminium housing
- Adjustable lamp position
- Plated

Renk:

- Krom

Colour:

- Chrome



GU 5.3



Decostar 51S

50 W



Ø75 mm



50x30x10 cm / 30 pcs

12 V

IP

20

JH573

**Malzeme:**

- Zamak gövde
- Hareketli
- Kaplama

Material:

- Die-cast zinc housing
- Adjustable lamp position
- Plated

Renk:

- Krom
- Saten Nikel

Colour:

- Chrome
- Satin Nickel

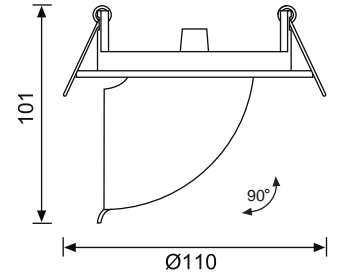

GU 5.3



Decostar 51S

50 W



Ø95 mm



59.5x25x45 cm / 50 pcs

12 V

IP

20

JH505

**Malzeme:**

- Alüminyum enjeksiyon gövde
- Hareketli
- Elektrostatik toz boyama

Material:

- Die-cast aluminium housing
- Adjustable lamp position
- Electrostatic powder coated

Renk:

- Beyaz
- Gümüş Gri

Colour:

- White
- Silver Gray

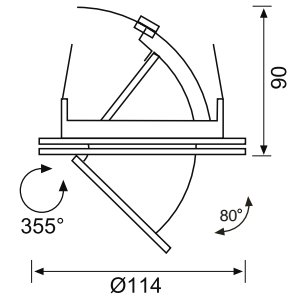

GU 5.3



Decostar 51S

50 W



Ø100 mm



24x60x60 cm / 50 pcs

12 V

IP

20

JH661

**Malzeme:**

- Alüminyum enjeksiyon gövde
- Hareketli
- Elektrostatik toz boyama

Material:

- Die-cast aluminium housing
- Adjustable lamp position
- Electrostatic powder coated

Renk:

- Beyaz

Colour:

- White

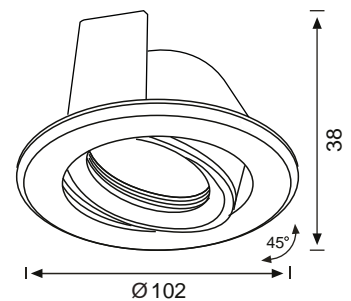

GU 5.3



Decostar 51S

50 W



Ø94 mm



54x43x28 cm / 100 pcs

12 V

IP

20

JH676

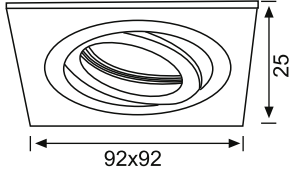
**Malzeme:**

- Alüminyum gövde
- Çok yönlü hareketli
- Ampülü önden değiştirilebilir

Material:

- Aluminium housing
- Multi-directional adjustable lamp position
- Bulb replaceable without dismounting

Renk:

- Saten Alüminyum & CD

Colour:

- Satin Aluminium & CD



GU 5.3



Decostar 51S

50 W



Ø80 mm



50x24x24 cm / 50 pcs

12 V

IP

20

JH677

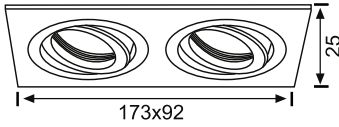
**Malzeme:**

- Alüminyum gövde
- Çok yönlü hareketli
- Ampülü önden değiştirilebilir

Material:

- Aluminium housing
- Multi-directional adjustable lamp position
- Bulb replaceable without dismounting

Renk:

- Saten Alüminyum & CD

Colour:

- Satin Aluminium & CD



GU 5.3



Decostar 51S

2x50 W



80x163 mm



59x19x27 cm / 30 pcs

12 V

IP

20

JH678

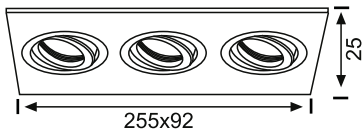
**Malzeme:**

- Alüminyum gövde
- Çok yönlü hareketli
- Ampülü önden değiştirilebilir

Material:

- Aluminium housing
- Multi-directional adjustable lamp position
- Bulb replaceable without dismounting

Renk:

- Saten Alüminyum & CD

Colour:

- Satin Aluminium & CD



GU 5.3



Decostar 51S

3x50 W



80x242 mm



59x27x27 cm / 30 pcs

12 V

IP

20

JH602



Malzeme:

- Alüminyum gövde
- Buzlu cam
- Kaplama

Material:

- Aluminium housing
- Frosted glass
- Plated

Renk:

- Alüminyum
- Krom

Colour:

- Aluminium
- Chrome

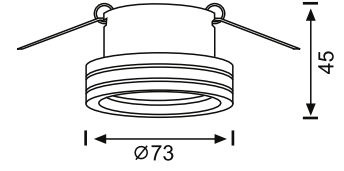

		50 W			42x18x31 cm / 50 pcs	12 V	IP 20
--	--	------	--	--	----------------------	------	--------------

JH593



Malzeme:

- Alüminyum gövde
- Hareketli

Material:

- Aluminium housing
- Adjustable lamp position

Renk:

- Saten Alüminyum & CD

Colour:

- Satin Aluminium & CD

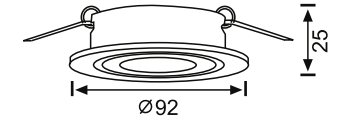

		50 W			50x24x24 cm / 50 pcs	12 V	IP 20
--	--	------	--	--	----------------------	------	--------------

JH622



Malzeme:

- Alüminyum gövde
- Hareketli

Material:

- Aluminium housing
- Adjustable lamp position

Renk:

- CD

Colour:

- CD

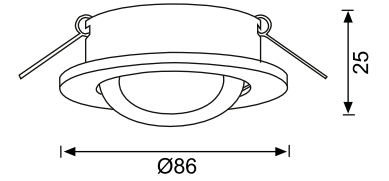

		50 W			46.5x37x23.5 cm / 100 pcs	12 V	IP 20
--	--	------	--	--	---------------------------	------	--------------

JH651



Malzeme:

- Zamak gövde
- Hareketli
- Elektrostatik toz boyama veya kaplama

Material:

- Die-cast zinc housing
- Adjustable lamp position
- Electrostatic powder coated or plated

Renk:

- Beyaz
- Krom
- Saten Nikel

Colour:

- White
- Chrome
- Satin Nickel

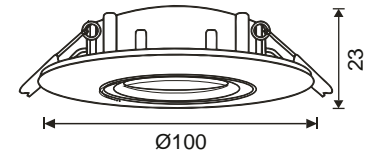

		50 W			54.5x22.5x20 cm / 50 pcs	12 V	IP 20
--	--	------	--	--	--------------------------	------	--------------

JH605

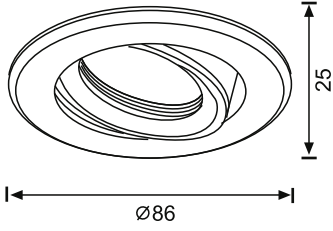

- Malzeme:**
- Alüminyum gövde
 - Hareketli
- Material:**
- Aluminium housing
 - Adjustable lamp position

- Renk:**
- Saten Alüminyum & CD
- Colour:**
- Satin Aluminium & CD



50 W

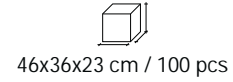

12 V



JH606

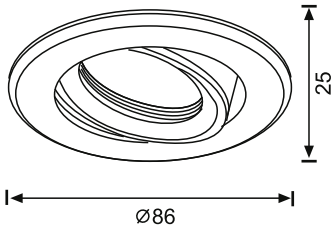

- Malzeme:**
- Alüminyum gövde
 - Hareketli
- Material:**
- Aluminium housing
 - Adjustable lamp position

- Renk:**
- Saten Alüminyum & CD
- Colour:**
- Satin Aluminium & CD



50 W

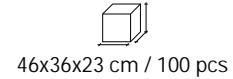

12 V



JH613

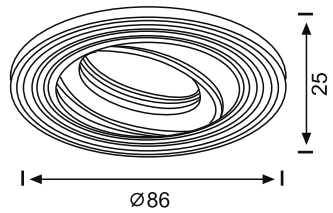

- Malzeme:**
- Alüminyum gövde
 - Hareketli
- Material:**
- Aluminium housing
 - Adjustable lamp position

- Renk:**
- CD & Siyah
- Colour:**
- CD & Black



50 W

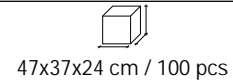

12 V



JH696

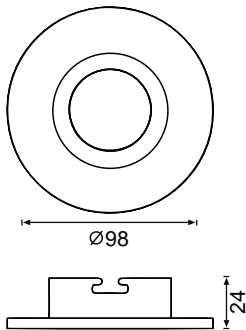

- Malzeme:**
- Alüminyum gövde
 - Elektrostatik toz boyama
- Material:**
- Aluminium housing
 - Electrostatic powder coated

- Renk:**
- Beyaz & Krom
- Colour:**
- White & Chrome



50 W

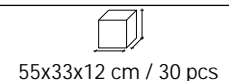

12 V



JH590







Malzeme:
• Alüminyum gövde

Material:
• Aluminium housing

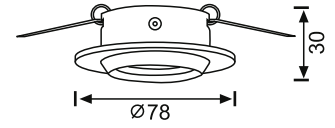
Renk:
• CD

Colour:
• CD



 GU 5.3	 Decostar 51S	50 W	 Ø60 mm	 52x21.5x30.5 cm / 50 pcs	12 V	IP 20
--	--	------	--	--	------	------------------------

JH591







Malzeme:
• Alüminyum gövde
• Hareketli

Material:
• Aluminium housing
• Adjustable lamp position

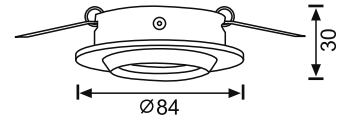
Renk:
• CD

Colour:
• CD



 GU 5.3	 Decostar 51S	50 W	 Ø75 mm	 52x21.5x30.5 cm / 50 pcs	12 V	IP 20
--	--	------	--	--	------	------------------------

JH594







Malzeme:
• Alüminyum gövde
• Hareketli

Material:
• Aluminium housing
• Adjustable lamp position

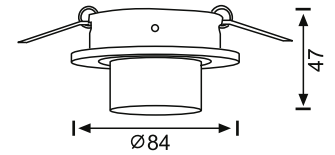
Renk:
• Alüminyum

Colour:
• Aluminium



 GU 5.3	 Decostar 51S	50 W	 Ø70 mm	 52x21.5x30.5 cm / 50 pcs	12 V	IP 20
--	--	------	--	--	------	------------------------

JH566







Malzeme:
• Alüminyum gövde
• Isıya dayanıklı cam

Material:
• Aluminium housing
• Tempered glass

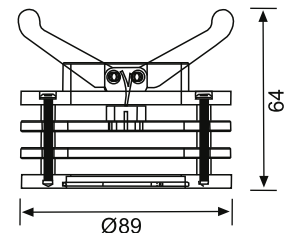
Renk:
• Alüminyum

Colour:
• Aluminium



 GU 5.3	 Decostar 51S	50 W	 Ø60 mm	 52x21.5x30.5 cm / 50 pcs	12 V	IP 20
--	--	------	--	--	------	------------------------

JH626

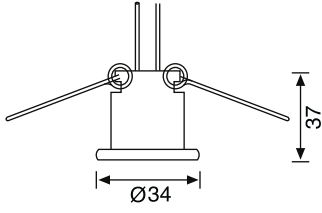
**Malzeme:**

- Zamak gövde
- Kaplama

Material:

- Die-cast zinc housing
- Plated

Renk:

- Krom

Colour:

- Chrome



G 4



Halostar

20 W



Ø30 mm



38x28x25 cm / 100 pcs

12 V

IP
20

JH629

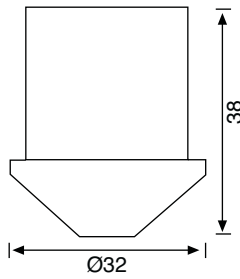
**Malzeme:**

- Zamak gövde
- Kaplama

Material:

- Die-cast zinc housing
- Plated

Renk:

- Krom

Colour:

- Chrome



G 4



Halostar

20 W



Ø26 mm



38x28x25 cm / 100 pcs

12 V

IP
20

JH511

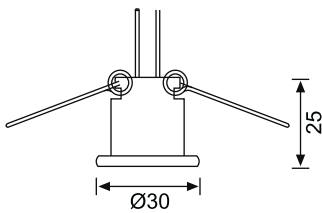
**Malzeme:**

- Zamak gövde
- Kaplama

Material:

- Die-cast zinc housing
- Plated

Renk:

- Krom

Colour:

- Chrome



G 4



Halostar

20 W



Ø24 mm



35x16x27 cm / 100 pcs

12 V

IP
20

JH522

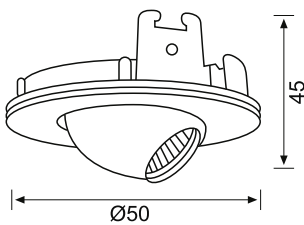
**Malzeme:**

- Zamak gövde
- Hareketli
- Kaplama

Material:

- Die-cast zinc housing
- Adjustable lamp position
- Plated

Renk:

- Krom
- Saten Nikel

Colour:

- Chrome
- Satin Nickel



G 4



Halostar

20 W



Ø45 mm



30x37x32 cm / 100 pcs

12 V

IP
20

LS452



Malzeme:

- Metal gövde
- Kaplama
- LED sürücülü

Material:

- Steel housing
- Plated
- With LED driver

Renk:

- Saten Nikel

Colour:

- Satin Nickel

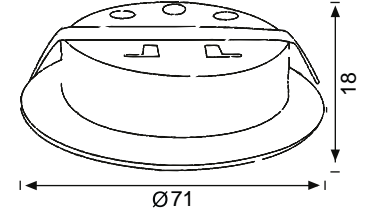

LED

LED Tipi	Renk Sıcaklığı	Işık Akısı	Sistem Gücü	Voltaj	Ø68 mm	40x32x15 cm / 100 pcs	Y	IP 20
SMD LED	3000 K	150 lm	2.5 W	230V				

LS438



Malzeme:

- Anahtarlı paslanmaz çelik gövde
- Dahili LED sürücülü

Material:

- S.S. housing with switch
- Built-in LED driver

Renk:

- Saten Nikel

Colour:

- Satin Nickel

CREE inside

LED

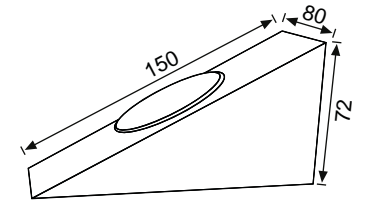

LED Tipi	Renk Sıcaklığı	Işık Akısı	Sistem Gücü	Voltaj	56x36x32 cm / 36 pcs	Y	IP 20
Cree COB LED	3000 K	200 lm	3 W	230V			

LS445



Malzeme:

- Anahtarlı ve topraklı prizli paslanmaz çelik gövde
- Dahili LED sürücülü

Material:

- S.S. housing with switch and grounding plug
- Built-in LED driver

Renk:

- Saten Nikel

Colour:

- Satin Nickel

EPISTAR inside

LED

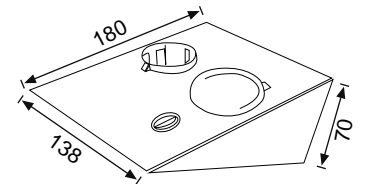

LED Tipi	Renk Sıcaklığı	Işık Akısı	Sistem Gücü	Voltaj	40x36x32 cm / 20 pcs	Y	IP 20
Epistar SMD LED	3000 K	200 lm	3 W	230V			



JH700



JH692



JH699



JH693

JH700



- Malzeme:**
- Alüminyum enjeksiyon gövde
 - Su bazlı boya

- Material:**
- Die-cast aluminium housing
 - Water painted

- Renk:**
- Mat Beyaz

- Colour:**
- Matt White

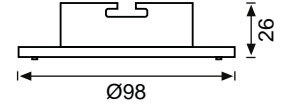

 GU 5.3	 Decostar 51S	50 W	 Ø70 mm	 55x34x14 cm / 30 pcs	12 V	IP 20
--	--	------	--	--	------	------------------------

JH692







- Malzeme:**
- Alüminyum gövde
 - Kaplama

- Material:**
- Aluminium housing
 - Plated

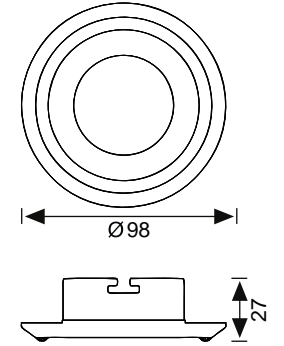
- Renk:**
- Krom

- Colour:**
- Chrome



 GU 5.3	 Decostar 51S	50 W	 Ø65 mm	 55x33x12 cm / 30 pcs	12 V	IP 20
--	--	------	--	--	------	------------------------

JH693



- Malzeme:**
- Alüminyum gövde
 - Kaplama

- Material:**
- Aluminium housing
 - Plated

- Renk:**
- Altın

- Colour:**
- Gold

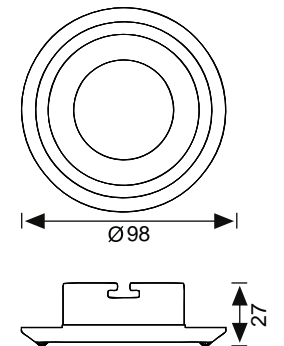

 GU 5.3	 Decostar 51S	50 W	 Ø65 mm	 55x33x12 cm / 30 pcs	12 V	IP 20
--	--	------	--	--	------	------------------------

JH699

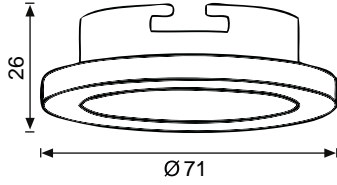
**Malzeme:**

- Alüminyum gövde
- Su bazlı boya

Material:

- Aluminium housing
- Water painted

Renk:

- Beyaz

Colour:

- White



GU 5.3



Decostar 51S

50 W



Ø65 mm



40x30x12 cm / 30 pcs

12 V

IP

20

JH575

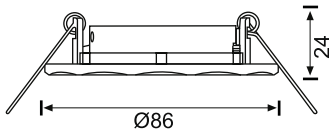
**Malzeme:**

- Zamak gövde
- Hareketli
- Kaplama

Material:

- Die-cast zinc housing
- Adjustable lamp position
- Plated

Renk:

- Krom & Kırmızı

Colour:

- Chrome & Red



GU 5.3



Decostar 51S

50 W



Ø73 mm



47x38x27.5 cm / 100 pcs

12 V

IP

20

JH503

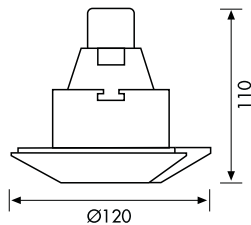
**Malzeme:**

- Alüminyum enjeksiyon gövde
- Isiya dayanıklı cam
- Elektrostatik toz boya veya kaplama

Material:

- Die cast aluminium housing
- Tempered glass
- Electrostatic powder coated or plated

Renk:

- Beyaz
- Altın

Colour:

- White
- Gold



GU 5.3



Decostar 51S

50 W



Ø83 mm



63x26x25 cm / 20 pcs

12 V

IP

20

JH641



- Malzeme:**
- Metal gövde
 - Şeffaf cam
 - Kaplama

- Material:**
- Steel housing
 - Clear glass
 - Plated

- Renk:**
- Krom
- Colour:**
- Chrome

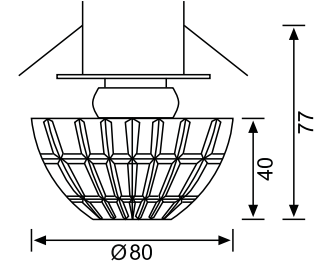

G 4



Halostar

20 W



Ø45 mm



57x23.5x35 cm / 30 pcs

12 V

IP

20

JH681



- Malzeme:**
- Alüminyum gövde
 - Şeffaf cam
 - Kaplama

- Material:**
- Aluminium housing
 - Clear glass
 - Plated

- Renk:**
- Krom
- Colour:**
- Chrome

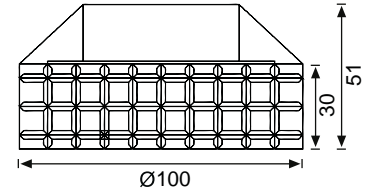

GU 5.3



Decostar 51S

50 W



Ø60 mm



50x30x26 cm / 30 pcs

12 V

IP

20

JH690



- Malzeme:**
- Metal gövde
 - Şeffaf cam
 - Kaplama

- Material:**
- Steel housing
 - Clear glass
 - Plated

- Renk:**
- Krom
- Colour:**
- Chrome

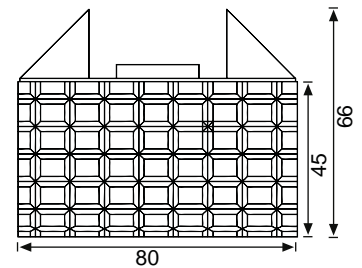

GY 6.35



Halostar

50 W



Ø60 mm



47x20x32 cm / 30 pcs

12 V

IP

20

JH642

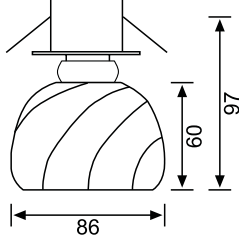
**Malzeme:**

- Metal gövde
- Şeffaf cam
- Kaplama

Material:

- Steel housing
- Clear glass
- Plated

Renk:

- Krom

Colour:

- Chrome



G 4



Halostar

20 W



Ø45 mm



57x23.5x35 cm / 30 pcs

12 V

IP
20

JH701

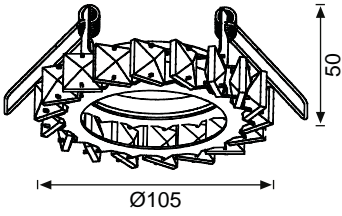
**Malzeme:**

- Paslanmaz çelik gövde
- Kaplama

Material:

- Stainless steel housing
- Plated

Renk:

- Krom

Colour:

- Chrome



GU 5.3



Decostar 51S

50 W



Ø60 mm



57x23x20 cm / 30 pcs

12 V

IP
20

JH702

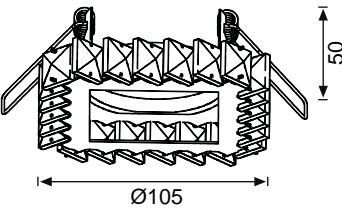
**Malzeme:**

- Paslanmaz çelik gövde
- Kaplama

Material:

- Stainless steel housing
- Plated

Renk:

- Krom

Colour:

- Chrome



GU 5.3



Decostar 51S

50 W



Ø60 mm



57x23x20 cm / 30 pcs

12 V

IP
20

JH561

**Malzeme:**

- Zamak gövde
- Şeffaf cam
- Kaplama

Material:

- Die-cast zinc housing
- Clear glass
- Plated

Renk:
• Krom

Colour:
• Chrome

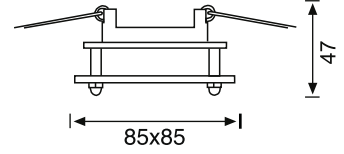

GU 5.3



Decostar 51S

50 W



Ø65 mm



50x20.5x27 cm / 50 pcs

12 V

IP

20

JH513

**Malzeme:**

- Alüminyum enjeksiyon gövde
- Buzlu cam
- Elektrostatik toz boyama

Material:

- Die-cast aluminium housing
- Frosted glass
- Electrostatic powder coated

Renk:
• Mat Krom

Colour:
• Matt Chrome

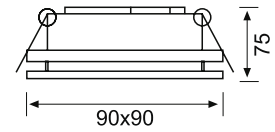

GU 5.3



Decostar 51S

50 W



Ø70 mm



50.5x21x28 cm / 50 pcs

12 V

IP

20

JH527

**Malzeme:**

- Alüminyum enjeksiyon gövde
- Alüminyum reflektör
- Buzlu cam
- Elektrostatik toz boyama

Material:

- Die-cast aluminium housing
- Aluminium reflector
- Frosted glass
- Electrostatic powder coated

Renk:
• Krom

Colour:
• Chrome

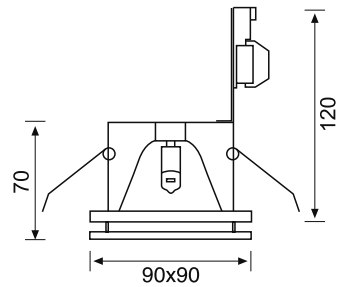

GY 6.35



Halostar

50 W



77x77 mm



50x35x45 cm / 50 pcs

12 V

IP

20

JH567

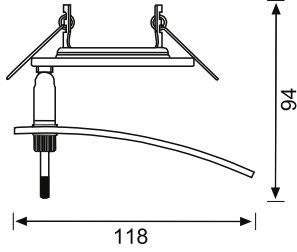
**Malzeme:**

- Zamak gövde
- Buzlu cam
- Kaplama

Material:

- Die-cast zinc housing
- Frosted glass
- Plated

Renk:

- Krom

Colour:

- Chrome



GU 5.3



Decostar 51S

50 W



Ø62 mm



64.5x29x45 cm / 50 pcs

12 V

IP

20

JH582

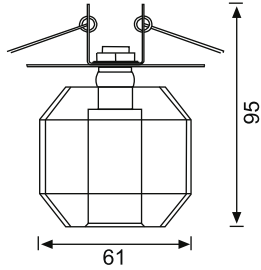
**Malzeme:**

- Metal gövde
- Şeffaf cam
- Kaplama

Material:

- Steel housing
- Clear glass
- Plated

Renk:

- Krom

Colour:

- Chrome



G 4



Halostar

20 W



Ø45 mm



52x52x25 cm / 40 pcs

12 V

IP

20

JH502

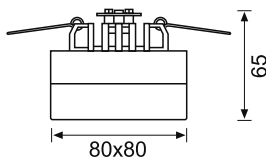
**Malzeme:**

- Zamak gövde
- Buzlu cam
- Kaplama

Material:

- Die-cast zinc housing
- Frosted glass
- Plated

Renk:

- Krom

Colour:

- Chrome



GY 6.35



Halostar

50 W



Ø65 mm



39.5x39.5x20 cm / 50 pcs

12 V

IP

20

JH632





- Malzeme:**
- Metal gövde
 - Süt beyazı cam

- Material:**
- Steel housing
 - Milky white glass

- Renk:**
- Krom

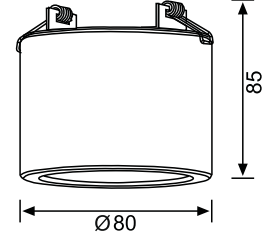
- Colour:**
- Chrome



 GY 6.35	 Halostar	50 W	 Ø45 mm	 48x20x23 cm / 20 pcs	12 V	IP 20
---	--	------	--	--	------	------------------------

JH658



- Malzeme:**
- Alüminyum gövde
 - Buzlu cam
 - Kaplama

- Material:**
- Aluminium housing
 - Frosted glass
 - Plated

- Renk:**
- Krom

- Colour:**
- Chrome

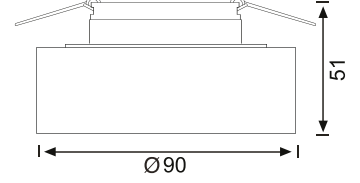

 GU 5.3	 Decostar 51S	50 W	 Ø60 mm	 57x24x26 cm / 30 pcs	12 V	IP 20
--	--	------	--	--	------	------------------------

JH657



- Malzeme:**
- Alüminyum gövde
 - Şeffaf cam
 - Kaplama

- Material:**
- Aluminium housing
 - Clear glass
 - Plated

- Renk:**
- Krom

- Colour:**
- Chrome

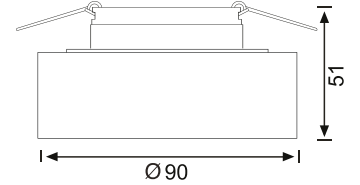

 GU 5.3	 Decostar 51S	50 W	 Ø60 mm	 57x24x26 cm / 30 pcs	12 V	IP 20
--	--	------	--	--	------	------------------------

JH543



- Malzeme:**
- Zamak gövde
 - Opal cam
 - Kaplama

- Material:**
- Die-cast zinc housing
 - Opal glass
 - Plated

- Renk:**
- Krom

- Colour:**
- Chrome

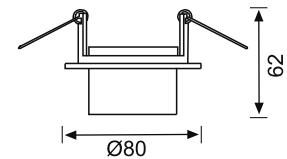

 GU 5.3	 Decostar 51S	50 W	 Ø58 mm	 45x19x37.5 cm / 50 pcs	12 V	IP 20
--	--	------	--	--	------	------------------------

JH560

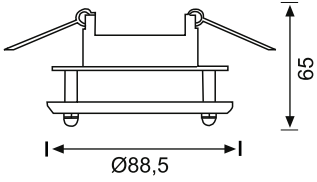
**Malzeme:**

- Zamak gövde
- Cam difüzör
- Kaplama

Material:

- Die-cast zinc housing
- Glass diffuser
- Plated

Renk:

- Krom

Colour:

- Chrome



GU 5.3



Decostar 51S

50 W



Ø65 mm



50x20.5x27 cm / 50 pcs

12 V

IP

20

JH537

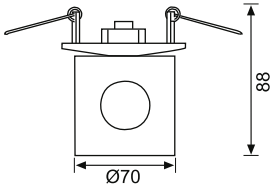
**Malzeme:**

- Zamak gövde
- Kaplama

Material:

- Die-cast zinc housing
- Plated

Renk:

- Krom

Colour:

- Chrome



G 4



Halostar

20 W



Ø60 mm



42x18x32.5 cm / 50 pcs

12 V

IP

20

JH604

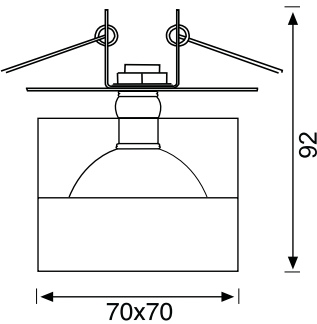
**Malzeme:**

- Metal gövde
- Şeffaf ve amber cam
- Kaplama

Material:

- Steel housing
- Clear and amber glass
- Plated

Renk:

- Krom

Colour:

- Chrome



G 4



Halostar

20 W



Ø45 mm



49x20x49 cm / 40 pcs

12 V

IP

20

JH683



Malzeme:
• Metal gövde
• Şeffaf cam
• Kaplama

Material:
• Steel housing
• Clear glass
• Plated

Renk:
• Krom

Colour:
• Chrome

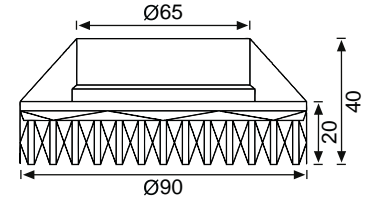

GU 5.3



Decostar 51S

50 W



Ø65 mm



50x30x26 cm / 30 pcs

12 V

IP

20

JH611



Malzeme:
• Alüminyum enjeksiyon ve paslanmaz çelik gövde
• Şeffaf cam
• Kaplama

Material:
• Die-cast aluminium and SS housing
• Clear glass
• Plated

Renk:
• Krom

Colour:
• Chrome

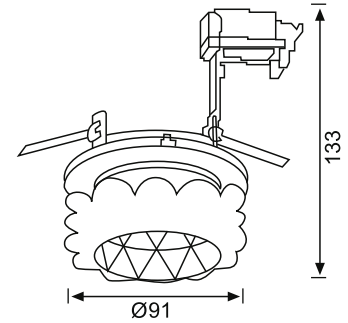

GU 5.3



Decostar 51S

50 W



Ø75 mm



59.5x27x47.5 cm / 50 pcs

12 V

IP

20

JH557

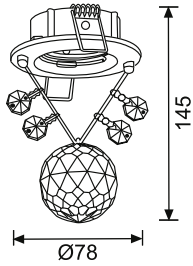
**Malzeme:**

- Metal gövde
- Şeffaf cam
- Kaplama

Material:

- Steel housing
- Clear glass
- Plated

Renk:

- Krom

Colour:

- Chrome



GU 5.3



Decostar 51S

50 W



Ø62 mm



45x19x60 cm / 50 pcs

12 V

IP

20

JH558

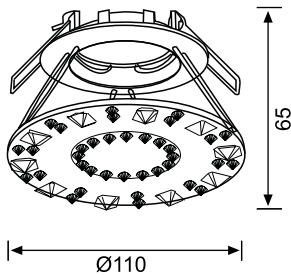
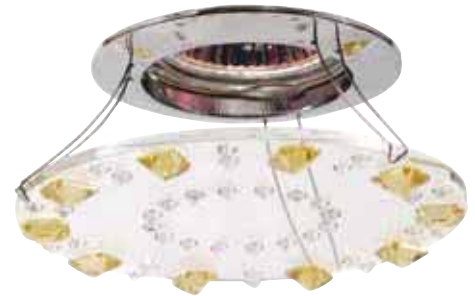
**Malzeme:**

- Zamak gövde
- Şeffaf ve zirkon cam
- Kaplama

Material:

- Die-cast zinc housing
- Clear and zircon glass
- Plated

Renk:

- Krom

Colour:

- Chrome



GU 5.3



Decostar 51S

50 W



Ø62 mm



62x26x45 cm / 50 pcs

12 V

IP

20

JH616



Malzeme:

- Alüminyum gövde
- Aynalı cam
- Kaplama

Material:

- Aluminium housing
- Mirror glass
- Plated

Renk:
• Krom

Colour:
• Chrome

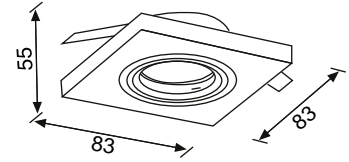

GU 5.3



Decostar 51S

50 W



Ø62 mm



57x24x27.5 cm / 50 pcs

12 V

IP

20

JH647



Malzeme:

- Alüminyum gövde
- Aynalı cam
- Kaplama

Material:

- Aluminium housing
- Mirror glass
- Plated

Renk:
• Krom

Colour:
• Chrome

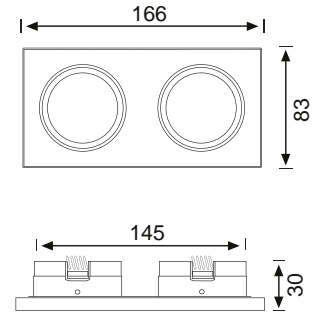

GU 5.3



Decostar 51S

2x50 W



65x145 mm



57x37x16 cm / 30 pcs

12 V

IP

20

JH649



Malzeme:

- Alüminyum gövde
- Aynalı cam
- Kaplama

Material:

- Aluminium housing
- Mirror glass
- Plated

Renk:
• Krom

Colour:
• Chrome

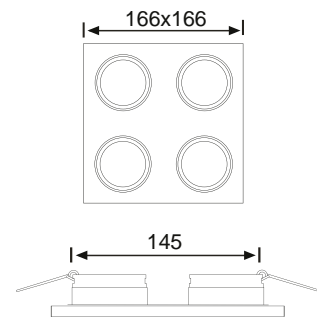

GU 5.3



Decostar 51S

4x50 W



145x145 mm



41x41x25 cm / 20 pcs

12 V

IP

20

JH615

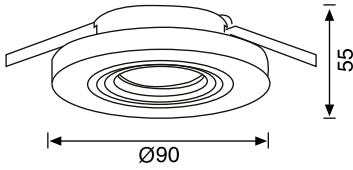
**Malzeme:**

- Alüminyum gövde
- Aynalı cam
- Kaplama

Material:

- Aluminium housing
- Mirror glass
- Plated

Renk:

- Krom

Colour:

- Chrome



GU 5.3



Decostar 51S

50 W



Ø62 mm



57x24x27.5 cm / 50 pcs

12 V

IP
20

JH635

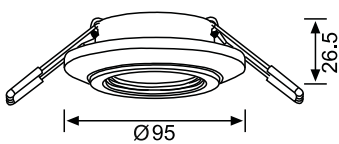
**Malzeme:**

- Alüminyum gövde
- Aynalı cam
- Kaplama

Material:

- Aluminium housing
- Mirror glass
- Plated

Renk:

- Krom

Colour:

- Chrome



GU 5.3



Decostar 51S

50 W



Ø60 mm



52x21.5x19.5 cm / 50 pcs

12 V

IP
20



LS444



LS443



LS457

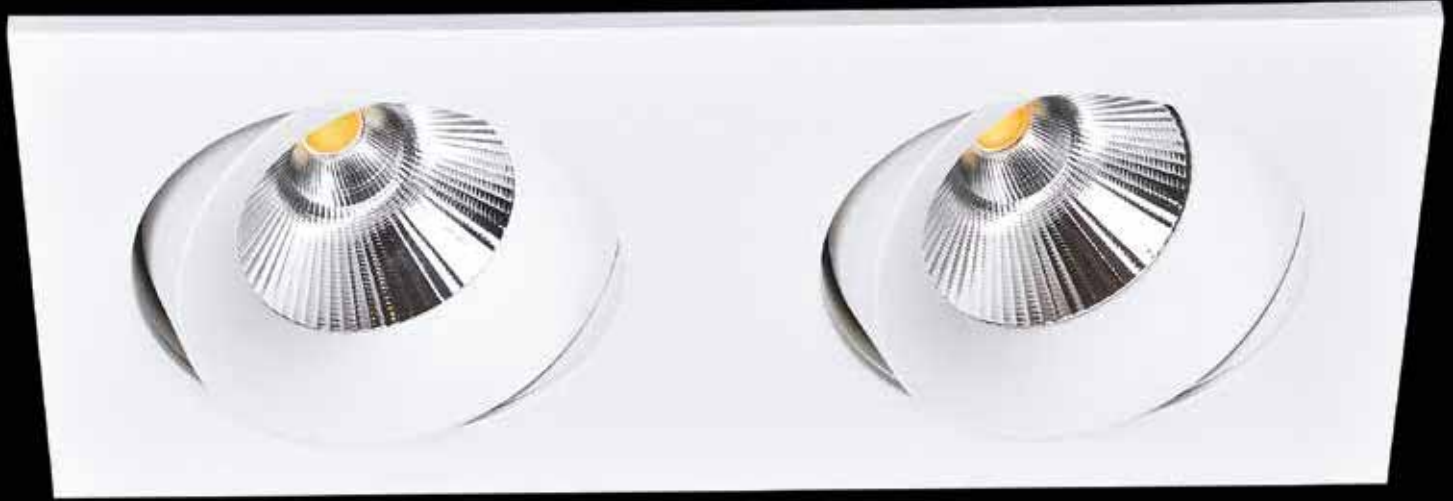

LS442



LS440



LS441

LS457



Malzeme:

- Alüminyum gövde
- Elektrostatik toz boyama
- LED sürücülü

Material:

- Aluminium housing
- Electrostatic powder coated
- With LED driver

Renk:

- Beyaz

Colour:

- White

bridgelux. inside

LED

NEW

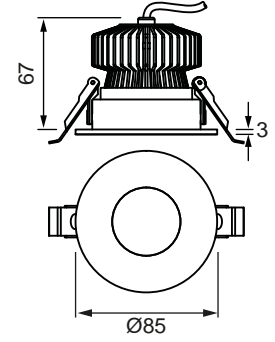

LED Tipi	Renk Sıcaklığı	Işık Akısı	Sistem Gücü	Voltaj	Ø	Y	IP
Bridgelux COB LED	3000 K	628 lm	6 W	230 V	Ø72 mm	36°	55,5x45,5x32 cm / 48 pcs

LS444



Malzeme:

- Tornalanmış alüminyum gövde
- Hareketli
- Elektrostatik toz boyama
- LED sürücülü 500mA

Material:

- Die-cast aluminium housing
- Adjustable lamp position
- Electrostatic powder coated
- Built-in 500mA LED driver

Renk:

- Beyaz

Colour:

- White

bridgelux. inside

LED

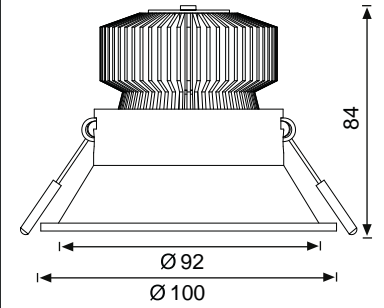

LED Tipi	Renk Sıcaklığı	Işık Akısı	Sistem Gücü	Voltaj	Ø	Y	IP
Bridgelux COB LED	3000 K	850 lm	11 W	230V	Ø92 mm	30°	45x35x35 cm / 36 pcs

LS443



Malzeme:

- Alüminyum enjeksiyon gövde
- Elektrostatik toz boyama
- LED sürücülü 500mA

Material:

- Die-cast aluminium housing
- Electrostatic powder coated
- Built-in 500mA LED driver

Renk:

- Beyaz

Colour:

- White

bridgelux. inside

LED

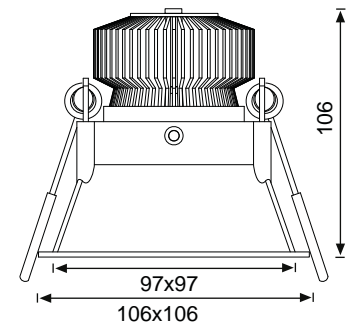

LED Tipi	Renk Sıcaklığı	Işık Akısı	Sistem Gücü	Voltaj	Ø	Y	IP
Bridgelux COB LED	3000 K	850 lm	11 W	230V	97x97 mm	30°	48x39x42 cm / 36 pcs

LED bridgelux® inside

LS440

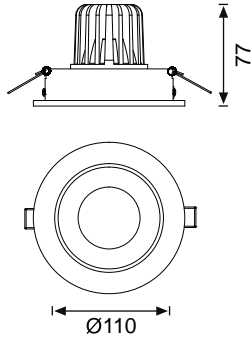
**Malzeme:**

- Alüminyum gövde
- Plastik reflektör
- Hareketli
- Elektrostatik toz boyama
- LED sürücülü 500mA

Material:

- Aluminium housing
- Plastic reflector
- Adjustable lamp position
- Electrostatic powder coated
- Built-in 500mA LED driver

Renk:

- Beyaz

Colour:

- White



LED Tipi	Renk Sıcaklığı	Işık Akısı	Sistem Gücü	Voltaj	Ø100 mm	30°	77x64.5x24 cm / 50 pcs	Y	IP 20
Bridgelux COB LED	3000 K	850 lm	11 W	230V	Ø100 mm	30°	77x64.5x24 cm / 50 pcs	Y	IP 20

LED bridgelux® inside

LS441

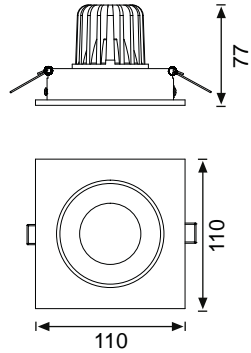
**Malzeme:**

- Alüminyum gövde
- Plastik reflektör
- Hareketli
- Elektrostatik toz boyama
- LED sürücülü 500mA

Material:

- Aluminium housing
- Plastic reflector
- Adjustable lamp position
- Electrostatic powder coated
- Built-in 500mA LED driver

Renk:

- Beyaz

Colour:

- White



LED Tipi	Renk Sıcaklığı	Işık Akısı	Sistem Gücü	Voltaj	Ø100 mm	30°	77x64.5x24 cm / 50 pcs	Y	IP 20
Bridgelux COB LED	3000 K	850 lm	11 W	230V	Ø100 mm	30°	77x64.5x24 cm / 50 pcs	Y	IP 20

LED bridgelux® inside

LS442

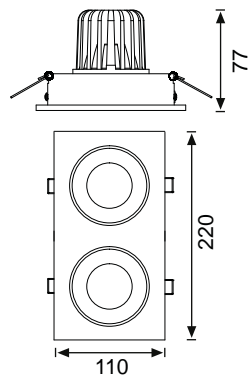
**Malzeme:**

- Alüminyum gövde
- Plastik reflektör
- Hareketli
- Elektrostatik toz boyama
- LED sürücülü 500mA

Material:

- Aluminium housing
- Plastic reflector
- Adjustable lamp position
- Electrostatic powder coated
- Built-in 500mA LED driver

Renk:

- Beyaz

Colour:

- White



LED Tipi	Renk Sıcaklığı	Işık Akısı	Sistem Gücü	Voltaj	190x100 mm	30°	77x49x24 cm / 20 pcs	Y	IP 20
Bridgelux COB LED	3000 K	1700 lm	2x11 W	230V	190x100 mm	30°	77x49x24 cm / 20 pcs	Y	IP 20

LS448



Malzeme:

- Alüminyum gövde
- LED sürücülü
- Su bazlı boya

Material:

- Aluminium housing
- With LED driver
- Water painted

Renk:

- Beyaz

Colour:

- White

EPISTAR inside

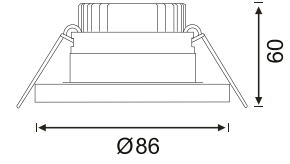

LED Tipi	Renk Sıcaklığı	Işık Akısı	Sistem Gücü	Voltaj	Ø75 mm	24°	46x24x40 cm / 40 pcs	Y	IP 20
Epistar COB LED	3000 K	510 lm	8 W	230V					

LS447



Malzeme:

- Alüminyum gövde
- LED sürücülü

Material:

- Aluminium housing
- With LED driver

Renk:

- CD

Colour:

- CD

EPISTAR inside

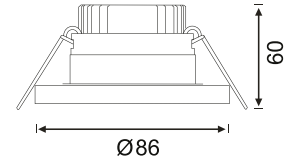

LED Tipi	Renk Sıcaklığı	Işık Akısı	Sistem Gücü	Voltaj	Ø75 mm	24°	46x24x39.5 cm / 40 pcs	Y	IP 20
Epistar COB LED	3000 K	510 lm	8 W	230V					

LS449



Malzeme:

- Alüminyum gövde
- LED sürücülü
- Kaplama

Material:

- Aluminium housing
- With LED driver
- Plated

Renk:

- Saten Nikel

Colour:

- Satin Nickel

EPISTAR inside

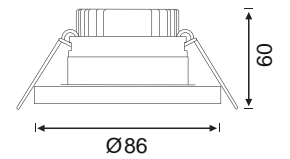

LED Tipi	Renk Sıcaklığı	Işık Akısı	Sistem Gücü	Voltaj	Ø75 mm	24°	48x25x40 cm / 40 pcs	Y	IP 20
Epistar COB LED	3000 K	510 lm	8 W	230V					

LED

LS456

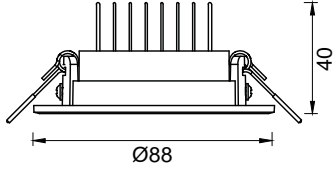

- Malzeme:**
- Plastik gövde
 - LED sürücülü
 - Alüminyum soğutuculu

- Material:**
- Plastic housing
 - With LED driver
 - Aluminium heatsink

- Renk:**
- Beyaz

- Colour:**
- White



LED Tipi	Renk Sıcaklığı	Işık Akısı	Sistem Gücü	Voltaj	Ø72 mm	120°	55x55x24.5 cm / 100 pcs	Y	IP 20
COB LED	3000 K / 6500 K	425 lm	6 W	230 V					

LED

EPISTAR inside

LS450

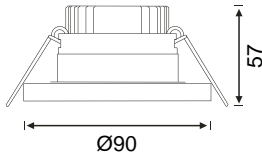

- Malzeme:**
- Alüminyum gövde
 - Aynalı cam
 - LED sürücülü

- Material:**
- Aluminium housing
 - Mirror glass
 - With LED driver

- Renk:**
- Krom & Ayna Cam

- Colour:**
- Chrome & Mirror Glass



LED Tipi	Renk Sıcaklığı	Işık Akısı	Sistem Gücü	Voltaj	Ø75 mm	24°	35x25x39.5 cm / 30 pcs	Y	IP 20
Epistar COB LED	3000 K	510 lm	8 W	230V					

LED

EPISTAR inside

LS451

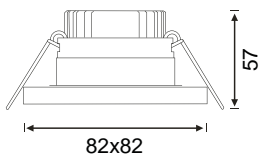

- Malzeme:**
- Alüminyum gövde
 - Aynalı cam
 - LED sürücülü

- Material:**
- Aluminium housing
 - Mirror glass
 - With LED driver

- Renk:**
- Krom & Ayna Cam

- Colour:**
- Chrome & Mirror Glass



LED Tipi	Renk Sıcaklığı	Işık Akısı	Sistem Gücü	Voltaj	Ø75 mm	24°	46x24x39.5 cm / 30 pcs	Y	IP 20
Epistar COB LED	3000 K	510 lm	8 W	230V					

LS590



- Malzeme:**
- Alüminyum enjeksiyon gövde
 - Aynalı cam
 - Kaplama
 - LED sürücülü

- Material:**
- Aluminium housing
 - Mirror glass
 - Plated
 - With LED driver

- Renk:**
- Krom

- Colour:**
- Chrome

EPISTAR inside

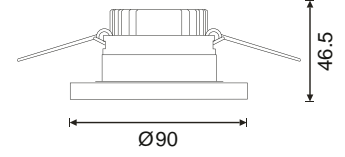

LED Tipi	Renk Sıcaklığı	Işık Akısı	Sistem Gücü	Voltaj	Ø	Y	IP
Epistar Power LED	6500 K	400 lm	7 W	230V	Ø65 mm	30°	52x22x26 cm / 30 pcs

LS595



- Malzeme:**
- Alüminyum gövde
 - Hareketli
 - LED sürücülü

- Material:**
- Aluminium housing
 - Adjustable lamp position
 - With LED driver

- Renk:**
- Alüminyum

- Colour:**
- Aluminium

EPISTAR inside

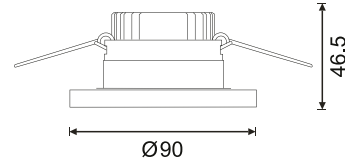

LED Tipi	Renk Sıcaklığı	Işık Akısı	Sistem Gücü	Voltaj	Ø	Y	IP
Epistar Power LED	6500 K	400 lm	7 W	230V	Ø72 mm	30°	41x21x38 cm / 40 pcs

LS596



- Malzeme:**
- Zamak gövde
 - Hareketli
 - Kaplama
 - LED sürücülü

- Material:**
- Die-cast zinc housing
 - Adjustable lamp position
 - Plated
 - With LED driver

- Renk:**
- Saten Nikel

- Colour:**
- Satin Nickel

EPISTAR inside

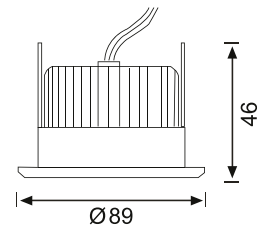

LED Tipi	Renk Sıcaklığı	Işık Akısı	Sistem Gücü	Voltaj	Ø	Y	IP
Epistar Power LED	6500 K	400 lm	7 W	230V	Ø82 mm	30°	42.5x22x40 cm / 40 pcs

LED

EPISTAR inside

LS591

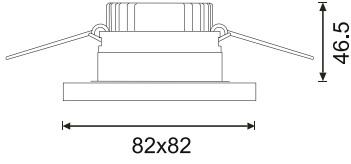
**Malzeme:**

- Alüminyum gövde
- Aynalı cam
- Kaplama
- LED sürücülü

Material:

- Aluminium housing
- Mirror glass
- Plated
- With LED driver

Renk:

- Krom

Colour:

- Chrome



LED Tipi	Renk Sıcaklığı	Işık Akısı	Sistem Gücü	Voltaj	Ø65 mm	30°	56x23x24 cm / 30 pcs	Y	IP 20
Epistar Power LED	3000 / 6500 K	400 lm	7 W	230V					

LED

EPISTAR inside

LS593

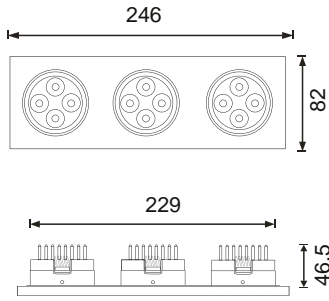
**Malzeme:**

- Alüminyum gövde
- Aynalı cam
- Kaplama
- LED sürücülü

Material:

- Aluminium housing
- Mirror glass
- Plated
- With LED driver

Renk:

- Krom

Colour:

- Chrome



LED Tipi	Renk Sıcaklığı	Işık Akısı	Sistem Gücü	Voltaj	65x230 mm	30°	56x25x37 cm / 20 pcs	Y	IP 20
Epistar Power LED	3000 K	1100 lm	21 W	230V					

LED

EPISTAR inside

LS594

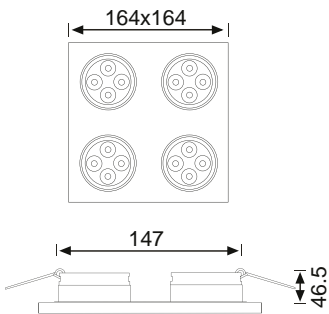
**Malzeme:**

- Alüminyum gövde
- Aynalı cam
- Kaplama
- LED sürücülü

Material:

- Aluminium housing
- Mirror glass
- Plated
- With LED driver

Renk:

- Krom

Colour:

- Chrome



LED Tipi	Renk Sıcaklığı	Işık Akısı	Sistem Gücü	Voltaj	145x145 mm	30°	41x41x23 cm / 20 pcs	Y	IP 20
Epistar Power LED	3000 K	1480 lm	28 W	230V					

LS454



Malzeme:

- Alüminyum enjeksiyon gövde
- LED sürücülü

Material:

- Die-cast aluminium housing
- With LED driver

Renk:

- Mat Beyaz

Colour:

- Matt White

EPISTAR inside

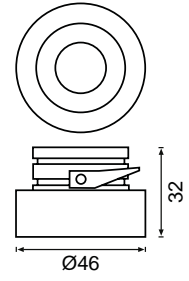

LED Tipi	Renk Sıcaklığı	Işık Akısı	Sistem Gücü	Voltaj	Ø	Yükseklik	Y	IP
Epistar COB LED	3000 K	150 lm	3 W	230 V	Ø40 mm	38x28x25 cm / 100 pcs	Y	IP 20

LS968



Malzeme:

- Alüminyum gövde
- LED sürücülü

Material:

- Aluminium housing
- With LED driver

Renk:

- Alüminyum

Colour:

- Aluminium

EPISTAR inside

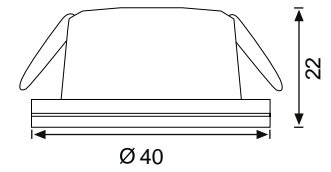

LED Tipi	Renk Sıcaklığı	Işık Akısı	Sistem Gücü	Voltaj	Ø	Açı	Yükseklik	Y	IP
Epistar Power LED	3000 / 6500 K	150 lm	3 W	230V	Ø32 mm	32°	38x15x27 cm / 50 pcs	Y	IP 20

LS954



Malzeme:

- Alüminyum gövde
- Hareketli
- LED sürücülü

Material:

- Aluminium housing
- Adjustable lamp position
- With LED driver

Renk:

- Alüminyum

Colour:

- Aluminium

EPISTAR inside

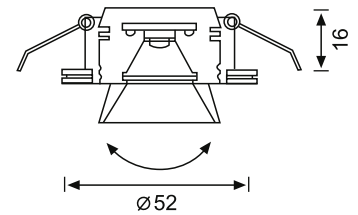

LED Tipi	Renk Sıcaklığı	Işık Akısı	Sistem Gücü	Voltaj	Ø	Açı	Yükseklik	Y	IP
Epistar Power LED	6500 K	150 lm	3 W	230V	Ø44 mm	30°	33.5x15x28 cm / 100 pcs	Y	IP 20

LS430



Malzeme:

- Alüminyum gövde
- Akrilik difüzör
- Elektrostatik toz boyama
- LED sürücülü

Material:

- Aluminium housing
- Acrylic diffuser
- Electrostatic powder coated
- With LED driver

Renk:

- Beyaz

Colour:

- White

EPISTAR inside

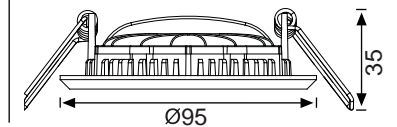

LED Tipi	Renk Sıcaklığı	Işık Akısı	Sistem Gücü	Voltaj	Ø	Açı	Yükseklik	Y	IP
Epistar SMD LED	3000 / 6500 K	300 lm	6 W	230V	Ø80 mm	120°	54x22.5x34.5 cm / 50 pcs	Y	IP 20

LED EPISTAR inside

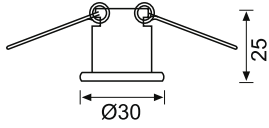

Malzeme:

- Zamak gövde
- Kaplama
- LED sürücülü

Material:

- Die-cast zinc housing
- Plated
- With LED driver

Renk:

- Krom

Colour:

- Chrome



LS950

LED Tipi	Renk Sıcaklığı	Işık Akısı	Sistem Gücü	Voltaj	Ø	Y	Y	IP
Epistar SMD LED	3000 / 6500 K	50 lm	1 W	230V	Ø25 mm	120°	38x29x27 cm / 100 pcs	20

LED EPISTAR inside

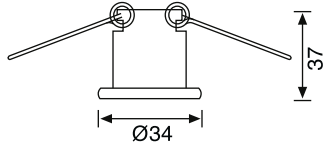

Malzeme:

- Zamak gövde
- LED sürücülü
- Kaplama

Material:

- Die-cast zinc housing
- With LED driver
- Plated

Renk:

- Krom

Colour:

- Chrome



LS972

LED Tipi	Renk Sıcaklığı	Işık Akısı	Sistem Gücü	Voltaj	Ø	Y	Y	IP
Epistar Power LED	3000 / 6500 K	100 lm	2 W	230V	Ø30 mm	30°	45x18x25 cm / 50 pcs	20

LED EPISTAR inside

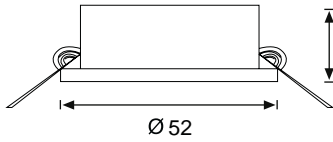

Malzeme:

- Zamak gövde
- Hareketli
- Kaplama
- LED sürücülü

Material:

- Die-cast zinc housing
- Adjustable lamp position
- Plated
- With LED driver

Renk:

- Krom

Colour:

- Chrome



LS967

LED Tipi	Renk Sıcaklığı	Işık Akısı	Sistem Gücü	Voltaj	Ø	Y	Y	IP
Epistar Power LED	3000 / 6500 K	100 lm	2 W	230V	Ø45 mm	30°	38x15x27 cm / 50 pcs	20

LED EPISTAR inside

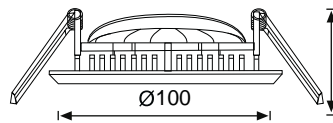

Malzeme:

- Alüminyum enjeksiyon gövde
- Akrilik difüzör
- LED sürücülü
- Kaplama

Material:

- Die-cast aluminium housing
- Acrylic diffuser
- With LED driver
- Plated

Renk:

- Saten Nikel

Colour:

- Satin Nickel



LS437

LED Tipi	Renk Sıcaklığı	Işık Akısı	Sistem Gücü	Voltaj	Ø	Y	Y	IP
Epistar SMD LED	3000 / 6500 K	300 lm	6 W	230V	Ø80 mm	120°	54x22.5x34.5 cm / 50 pcs	20

LW389



Malzeme:

- Alüminyum gövde
- LED sürücülü
- Su bazlı boya

Material:

- Aluminium housing
- With LED driver
- Water painted

Renk:

- Mat Beyaz

Colour:

- Matt White

EPISTAR inside

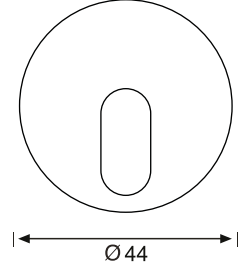

LED Tipi	Renk Sıcaklığı	Işık Akısı	Sistem Gücü	Voltaj	Ø40 mm	30°	38x29x27 cm / 100 pcs	Y	IP 20
Epistar Power LED	3000 K	50 lm	2 W	230V					

LW388



Malzeme:

- Alüminyum gövde
- LED sürücülü
- Su bazlı boya

Material:

- Aluminium housing
- With LED driver
- Water painted

Renk:

- Mat Beyaz

Colour:

- Matt White

EPISTAR inside

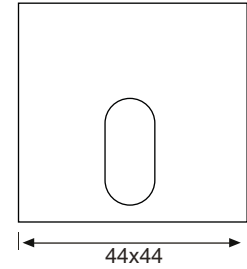

LED Tipi	Renk Sıcaklığı	Işık Akısı	Sistem Gücü	Voltaj	Ø40 mm	30°	38x29x27 cm / 100 pcs	Y	IP 20
Epistar Power LED	3000 K	50 lm	2 W	230V					

LW422



Malzeme:

- Alüminyum enjeksiyon gövde
- Elektrostatik toz boyama
- LED sürücülü
- Metal kör kasalı
- Çerçevesiz

Material:

- Die-cast aluminium housing
- Electrostatic powder coated
- With LED driver
- With steel sleeve
- Frameless

Renk:

- Mat Beyaz

Colour:

- Matt White

EPISTAR inside

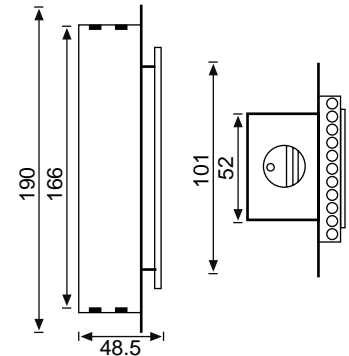

LED Tipi	Renk Sıcaklığı	Işık Akısı	Sistem Gücü	Voltaj	135x45 mm	30°	58x22x14 cm / 10 pcs	Y	IP 20
Epistar Power LED	3000 K	150 lm	3.5 W	230V					

LED

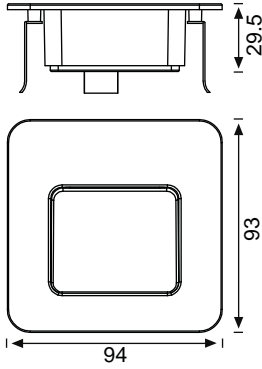
**Malzeme:**

- Alüminyum enjeksiyon gövde
- Dahili LED sürücüsü

Material:

- Die-cast aluminium housing
- Built-in LED driver

Renk:

- Kumlu Beyaz

Colour:

- Sandy White

LW459



LED Tipi	Renk Sıcaklığı	Işık Akısı	Sistem Gücü	Voltaj			Y	IP
SMD LED	3000 K	200 lm	4 W	230V	90x83 mm	54x22x24 cm / 30 pcs		44

LED

EPISTAR inside

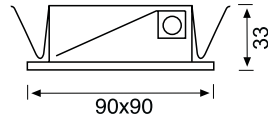
**Malzeme:**

- Alüminyum enjeksiyon gövde
- LED sürücüsü

Material:

- Die-cast aluminium housing
- With LED driver

Renk:

- Gümüş Gri

Colour:

- Silver Gray

LW399



LED Tipi	Renk Sıcaklığı	Işık Akısı	Sistem Gücü	Voltaj			Y	IP
Epistar COB LED	3000 K	150 lm	3 W	230V	77x77 mm	59x40x28 cm / 50 pcs		20

LED

EPISTAR inside

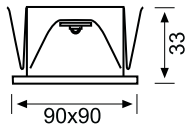
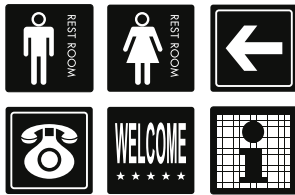
**Malzeme:**

- Alüminyum enjeksiyon gövde
- Buzlu cam
- LED sürücüsü

Material:

- Die-cast aluminium housing
- Frosted glass
- With LED driver

Renk:

- Gümüş Gri

Colour:

- Silver Gray

LW971



LED Tipi	Renk Sıcaklığı	Işık Akısı	Sistem Gücü	Voltaj			Y	IP
Epistar Power LED	3000 K / Kırmızı	50 lm	1 W	230V	77x77 mm	49x24.8x50 cm / 50 pcs		20

LS979



- Malzeme:**
- Polikarbonat gövde
 - ABS çerçeve
 - Besleme: 10-30 V AC/DC dahili LED sürücülü

- Material:**
- Polycarbonate housing
 - ABS frame
 - Operating voltage: 10-30 V AC/DC LED driver

- Renk:**
- Krom, Beyaz
- Colour:**
- Chrome, White

EPISTAR inside

LED



LED Tipi	Renk Sıcaklığı	Işık Akısı	Sistem Gücü	Voltaj	Ø	°	Y	IP
Epistar Power LED	3000 K	150 lm	4 W	12/24 V	Ø63mm	30°	55x21x37 cm / 50 pcs	65

LW966



- Malzeme:**
- Alüminyum gövde
 - Buzlu opal polikarbonat difüzör
 - Kaplama
 - Dahili LED sürücülü

- Material:**
- Aluminium housing
 - Frosted opal polycarbonate diffuser
 - Plated
 - Built-in LED driver

- Renk:**
- Saten Nikel
- Colour:**
- Satin Nickel

EPISTAR inside

LED

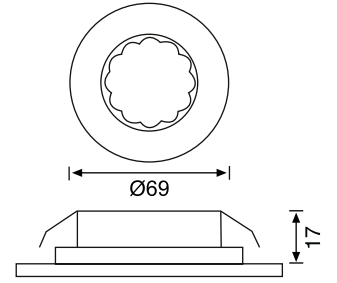

LED Tipi	Renk Sıcaklığı	Işık Akısı	Sistem Gücü	Voltaj	Ø	°	Y	IP
Epistar SMD LED	3000 K	130 lm	1.5 W	230V	Ø55mm	90°	37x40x19 cm / 100 pcs	20

LW983



- Malzeme:**
- Alüminyum gövde
 - Buzlu opal polikarbonat difüzör
 - Kaplama
 - Dahili LED sürücülü

- Material:**
- Aluminium housing
 - Frosted opal polycarbonate diffuser
 - Plated
 - Built-in LED driver

- Renk:**
- Saten Nikel
- Colour:**
- Satin Nickel

EPISTAR inside

LED

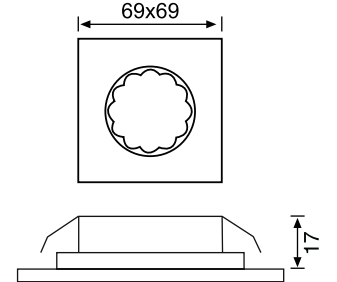

LED Tipi	Renk Sıcaklığı	Işık Akısı	Sistem Gücü	Voltaj	Ø	°	Y	IP
Epistar SMD LED	3000 K	130 lm	1.5 W	230V	Ø55mm	90°	45x40x19 cm / 100 pcs	20

LS398



- Malzeme:**
- Zamak gövde
 - LED sürücülü
 - Kaplama

- Material:**
- Die-cast zinc housing
 - With LED driver
 - Plated

- Renk:**
- Saten Nikel
- Colour:**
- Satin Nickel

EPISTAR inside

LED

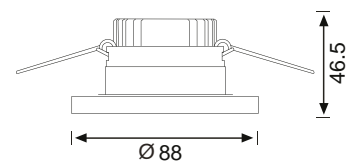

LED Tipi	Renk Sıcaklığı	Işık Akısı	Sistem Gücü	Voltaj	Ø	°	Y	IP
Epistar Power LED	3000 K	300 lm	3 W	230V	Ø77 mm	120°	38.5x31x23 cm / 100 pcs	20

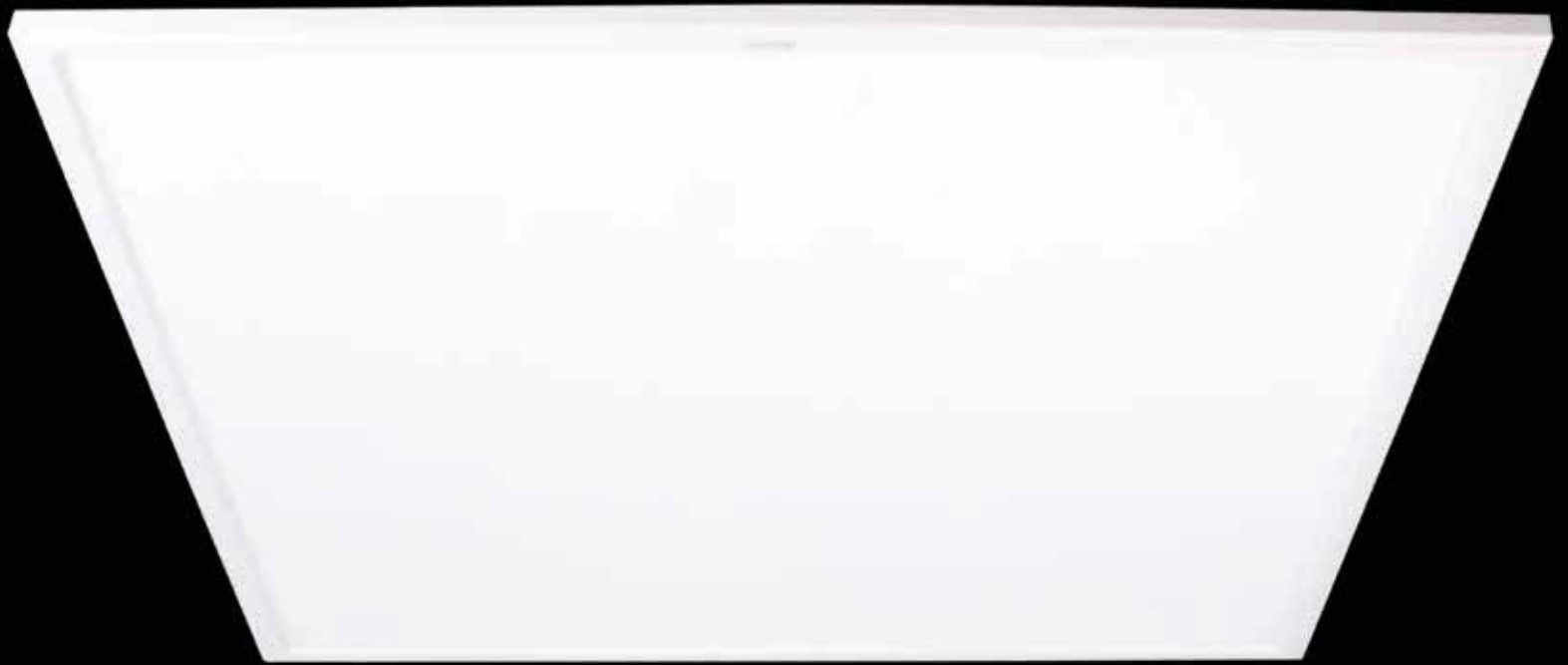

LD467



LD413



LD414

LD412

LED



Kullanım Yeri:

- 60x60 kaset tavana
- JK999 askı sistemi ile sarkıt olarak
- JC105 mandal ile alçıpan tavan

Usage:

- With 60x60 ceiling cassette
- With JK999 hanging apparatus
- With JC105 bolted to the dry wall ceiling

Malzeme:

- Alüminyum gövde
- Plastik çerçeve
- Opal polikarbonat difüzör
- LED sürücülü
- Side light

Material:

- Aluminium housing
- Plastic frame
- Opal polycarbonate diffuser
- With LED driver
- Side light

Renk:
• Beyaz

Colour:
• White

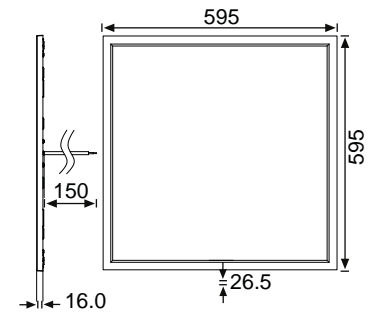

LED Tipi	Renk Sıcaklığı	Işık Akısı	Sistem Gücü	Voltaj	110°	65.8x65.8x32 cm / 5 pcs	Y	IP 20
SMD LED	3000 / 6500 K	2800 / 3000 lm	38 W	230V				

LED

LD467

**Kullanım Yeri:**

- 60x60 kaset tavana
- JK999 askı sistemi ile sarkıt olarak
- JC105 mandal ile alçıpan tavan

Usage:

- With 60x60 ceiling cassette
- With JK999 hanging apparatus
- With JC105 bolted to the dry wall ceiling

Malzeme:

- Alüminyum gövde
- Plastik çerçeve
- Opal polikarbonat difüzör
- LED sürücülü
- Back light

Material:

- Aluminium housing
- Plastic frame
- Opal polycarbonate diffuser
- With LED driver
- Back light

Renk:

- Beyaz

Colour:

- White

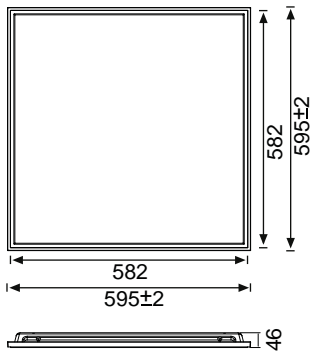

LED Tipi	Renk Sıcaklığı	Işık Akısı	Sistem Gücü	Voltaj			Y	IP
Power LED	3000 / 6500 K	2500 / 2700 lm	38 W	230V	110°	63x36.5x63 cm / 6 pcs		20

LD414



- Malzeme:**
- Alüminyum enjeksiyon gövde
 - Opal akrilik difüzör
 - Elektrostatik toz boyama
 - LED sürücülü

- Material:**
- Die-cast aluminium housing
 - Opal acrylic diffuser
 - Electrostatic powder coated
 - With LED driver

- Renk:**
- Beyaz

- Colour:**
- White

EPISTAR inside

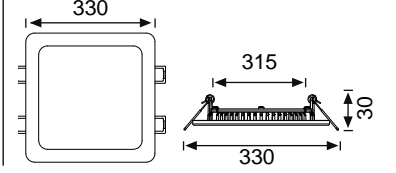

LED Tipi	Renk Sıcaklığı	Işık Akısı	Sistem Gücü	Voltaj	Ø	Y	IP
Epistar SMD LED	3000 / 6500 K	2800 / 3000 lm	32 W	230 V	315x315 mm	93x36x36 cm / 20 pcs	20

LD413

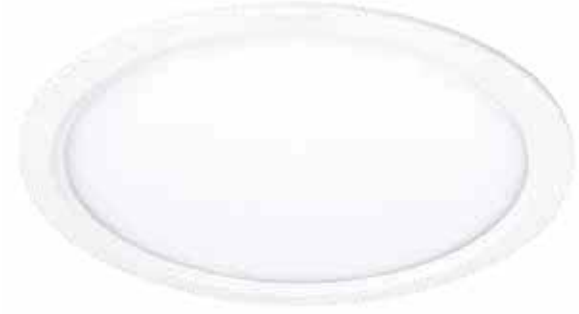

- Malzeme:**
- Alüminyum enjeksiyon gövde
 - Opal akrilik difüzör
 - Elektrostatik toz boyama
 - LED sürücülü

- Material:**
- Die-cast aluminium housing
 - Opal acrylic diffuser
 - Electrostatic powder coated
 - With LED driver

- Renk:**
- Beyaz

- Colour:**
- White

EPISTAR inside

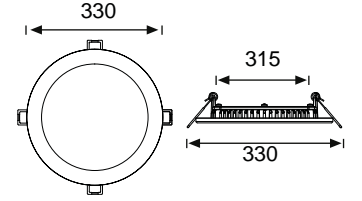

LED Tipi	Renk Sıcaklığı	Işık Akısı	Sistem Gücü	Voltaj	Ø	Y	IP
Epistar SMD LED	3000 / 6500 K	2300 / 2500 lm	24 W	230 V	Ø315mm	93x36x36 cm / 20 pcs	20

LD473

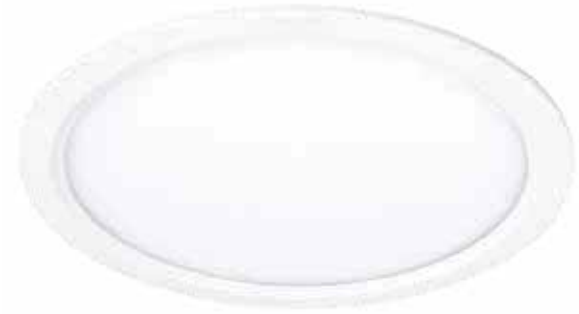

- Malzeme:**
- Alüminyum enjeksiyon gövde
 - Opal polikarbonat difüzör
 - Elektrostatik toz boyama
 - LED sürücülü

- Material:**
- Die-cast aluminium housing
 - Opal polycarbonate diffuser
 - Electrostatic powder coated
 - With LED driver

- Renk:**
- Beyaz

- Colour:**
- White

EPISTAR inside

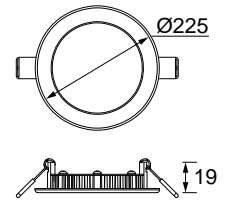

LED Tipi	Renk Sıcaklığı	Işık Akısı	Sistem Gücü	Voltaj	Ø	Y	IP
SMD LED	3000 K / 6500 K	1100 lm	18 W	230 V	Ø210mm	48x32x28 cm / 20 pcs	20

LED

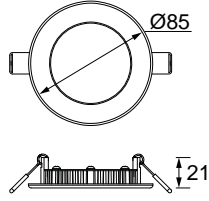
**Malzeme:**

- Alüminyum enjeksiyon gövde
- Opal polikarbonat difüzör
- Elektrostatik toz boyama
- LED sürücülü

Material:

- Die-cast aluminium housing
- Opal polycarbonate diffuser
- Electrostatic powder coated
- With LED driver

Renk:

- Beyaz

Colour:

- White

LD470



LED Tipi	Renk Sıcaklığı	Işık Akısı	Sistem Gücü	Voltaj			Y	IP
SMD LED	3000 K / 6500 K	110 lm	3 W	230 V	Ø70mm	57x32x28 cm / 100 pcs		20

LED

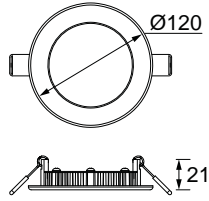
**Malzeme:**

- Alüminyum enjeksiyon gövde
- Opal polikarbonat difüzör
- Elektrostatik toz boyama
- LED sürücülü

Material:

- Die-cast aluminium housing
- Opal polycarbonate diffuser
- Electrostatic powder coated
- With LED driver

Renk:

- Beyaz

Colour:

- White

LD471



LED Tipi	Renk Sıcaklığı	Işık Akısı	Sistem Gücü	Voltaj			Y	IP
SMD LED	3000 K / 6500 K	280 lm	6 W	230 V	Ø110mm	50x26.5x65 cm / 100 pcs		20

LED

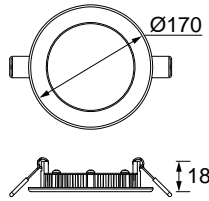
**Malzeme:**

- Alüminyum enjeksiyon gövde
- Opal polikarbonat difüzör
- Elektrostatik toz boyama
- LED sürücülü

Material:

- Die-cast aluminium housing
- Opal polycarbonate diffuser
- Electrostatic powder coated
- With LED driver

Renk:

- Beyaz

Colour:

- White

LD472



LED Tipi	Renk Sıcaklığı	Işık Akısı	Sistem Gücü	Voltaj			Y	IP
SMD LED	3000 K / 6500 K	720 lm	12 W	230 V	Ø160mm	50x36.5x36.5 cm / 40 pcs		20

LED

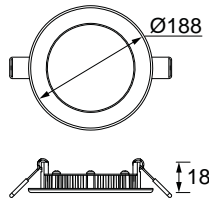
**Malzeme:**

- Alüminyum enjeksiyon gövde
- Opal polikarbonat difüzör
- Elektrostatik toz boyama
- LED sürücülü

Material:

- Die-cast aluminium housing
- Opal polycarbonate diffuser
- Electrostatic powder coated
- With LED driver

Renk:

- Beyaz

Colour:

- White

LD474



LED Tipi	Renk Sıcaklığı	Işık Akısı	Sistem Gücü	Voltaj			Y	IP
SMD LED	3000 K / 6500 K	900 lm	15 W	230 V	Ø170mm	43x25x43 cm / 20 pcs		20

LD415



Malzeme:

- Alüminyum enjeksiyon gövde
- Alüminyum reflektör
- Şeffaf akrilik difüzör
- Elektrostatik toz boyama
- LED sürücülü

Material:

- Die-cast aluminium housing
- Aluminium reflector
- Clear acrylic diffuser
- Electrostatic powder coated
- With LED driver

Renk:

- Beyaz

Colour:

- White

EPISTAR inside

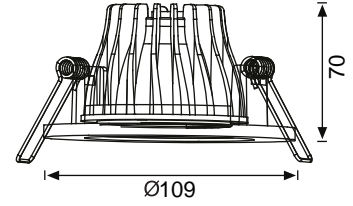

LED Tipi	Renk Sıcaklığı	Işık Akısı	Sistem Gücü	Voltaj	Ø	Y	IP
Epistar COB LED	6500 K	750 lm	11 W	230 V	Ø98mm	54x28x45 cm / 40 pcs	20

LD416



Malzeme:

- Alüminyum enjeksiyon gövde
- Alüminyum reflektör
- Şeffaf akrilik difüzör
- Elektrostatik toz boyama
- LED sürücülü

Material:

- Die-cast aluminium housing
- Aluminium reflector
- Clear acrylic diffuser
- Electrostatic powder coated
- With LED driver

Renk:

- Beyaz

Colour:

- White

EPISTAR inside

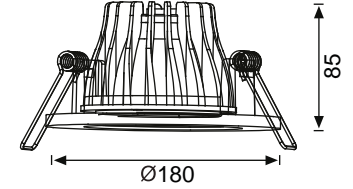

LED Tipi	Renk Sıcaklığı	Işık Akısı	Sistem Gücü	Voltaj	Ø	Y	IP
Epistar COB LED	6500 K	1500 lm	22 W	230 V	Ø160mm	58.5x39.5x55 cm / 30 pcs	20

LD397



Malzeme:

- Alüminyum enjeksiyon gövde
- Opal akrilik difüzör
- Elektrostatik toz boyama
- LED sürücülü

Material:

- Die-cast aluminium housing
- Opal acrylic diffuser
- Electrostatic powder coated
- With LED driver

Renk:

- Beyaz

Colour:

- White

EPISTAR inside

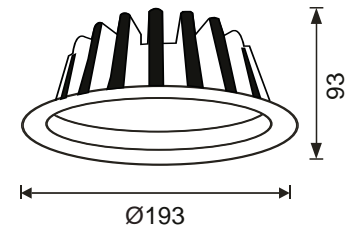

LED Tipi	Renk Sıcaklığı	Işık Akısı	Sistem Gücü	Voltaj	Ø	Y	IP
Epistar SMD LED	3000 / 6500 K	1900 lm	26 W	230 V	Ø170mm	47x47x31 cm / 12 pcs	20

JD561

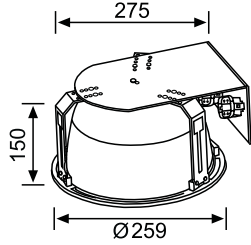
**Malzeme:**

- Alüminyum enjeksiyon gövde
- Alüminyum reflektör
- Akrilik difüzör
- Elektrostatik toz boyama
- Elektronik ve mekanik balastla uyumlu

Material:

- Die-cast aluminium housing
- Aluminium reflector
- Acrylic diffuser
- Electrostatic powder coated
- Ready for electronic and mechanical gear

**Renk:**

- Beyaz

Colour:

- White



G 24

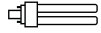

Dulux D / Dulux D-E

2x26 W



Ø245 mm



58x55x35 cm / 8 pcs



Y



IP 20

JD227

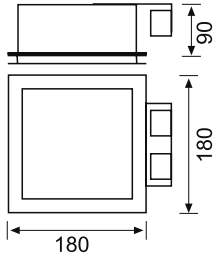
**Malzeme:**

- Metal gövde
- Alüminyum enjeksiyon çerçeve
- 5 mm buzlu cam
- Elektrostatik toz boyama
- Elektronik ve mekanik balastla uyumlu

Material:

- Steel housing
- Die-cast aluminium frame
- 5 mm frosted glass
- Electrostatic powder coated
- Ready for electronic and mechanical gear

**Renk:**

- Beyaz

Colour:

- White



G 24



Dulux D / Dulux D-E

2x26 W



162x162 mm



59x51x36.5 cm / 18 pcs



Y



IP 20

JD511

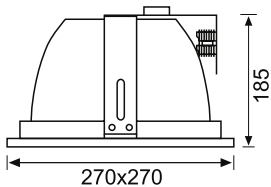
**Malzeme:**

- Alüminyum enjeksiyon gövde
- Alüminyum parabolik reflektör
- Elektrostatik toz boyama
- Elektronik ve mekanik balastla uyumlu

Material:

- Die-cast aluminium housing
- Aluminium parabolic reflector
- Electrostatic powder coated
- Ready for electronic and mechanical gear

**Renk:**

- Beyaz
- Gümüş Gri

Colour:

- White
- Silver Gray



G 24

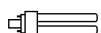

Dulux D / Dulux D-E

2x26 W



250x250 mm



60x34x58 cm / 6 pcs



Y



IP 20

JD527



Malzeme:

- Metal gövde
- Zamak çerçeve
- Alüminyum reflektör
- Kısmi buzlu cam
- Kaplama
- Elektronik ve mekanik balastla uyumlu

Material:

- Steel housing
- Zinc frame
- Aluminium reflector
- Semi-frosted glass
- Plated
- Ready for electronic and mechanical gear

Renk:

- Saten Nikel

Colour:

- Satin Nickel

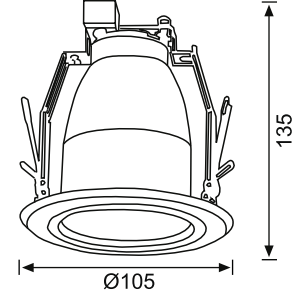

G 24



Dulux D / Dulux D-E

10 W



Ø90 mm



58.5x23.5x58 cm / 40 pcs



20

JD528



Malzeme:

- Metal gövde
- Zamak çerçeve
- Alüminyum reflektör
- Kısmi buzlu cam
- Kaplama
- Elektronik ve mekanik balastla uyumlu

Material:

- Steel housing
- Zinc frame
- Aluminium reflector
- Semi-frosted glass
- Plated
- Ready for electronic and mechanical gear

Renk:

- Saten Nikel

Colour:

- Satin Nickel

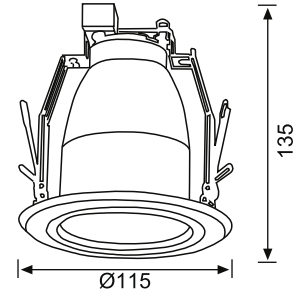

G 24



Dulux D / Dulux D-E

10 W



Ø95 mm



63x30x44 cm / 30 pcs



20

JD529



Malzeme:

- Metal gövde
- Zamak çerçeve
- Alüminyum reflektör
- Kısmi buzlu cam
- Kaplama
- Elektronik ve mekanik balastla uyumlu

Material:

- Steel housing
- Zinc frame
- Aluminium reflector
- Semi-frosted glass
- Plated
- Ready for electronic and mechanical gear

Renk:

- Saten Nikel

Colour:

- Satin Nickel

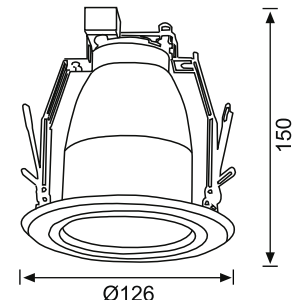

G 24



Dulux D / Dulux D-E

13 W



Ø110 mm



67x27.5x48 cm / 30 pcs



20

JD532

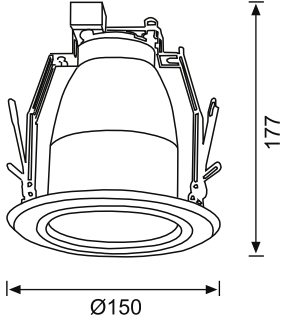
**Malzeme:**

- Metal gövde
- Zamak çerçeve
- Alüminyum reflektör
- Kısmi buzlu cam
- Kaplama
- Elektronik ve mekanik balastla uyumlu

Material:

- Steel housing
- Zinc frame
- Aluminium reflector
- Semi-frosted glass
- Plated
- Ready for electronic and mechanical gear

Renk:

- Saten Nikel

Colour:

- Satin Nickel



G 24

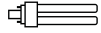

Dulux D / Dulux D-E

18 W



Ø135 mm



80x33x38 cm / 20 pcs



Y



IP 20

JD533

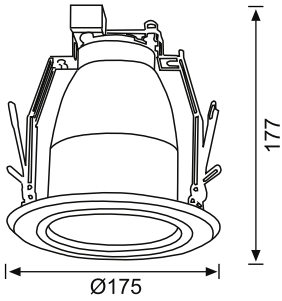
**Malzeme:**

- Metal gövde
- Zamak çerçeve
- Alüminyum reflektör
- Kısmi buzlu cam
- Kaplama
- Elektronik ve mekanik balastla uyumlu

Material:

- Steel housing
- Zinc frame
- Aluminium reflector
- Semi-frosted glass
- Plated
- Ready for electronic and mechanical gear

Renk:

- Saten Nikel

Colour:

- Satin Nickel



G 24



Dulux D / Dulux D-E

18 W



Ø160 mm



93x19.5x79 cm / 20 pcs



Y



IP 20

JD530

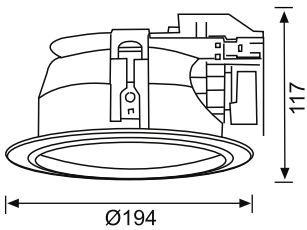
**Malzeme:**

- Metal gövde
- Zamak çerçeve
- Alüminyum reflektör
- Kısmi buzlu cam
- Kaplama
- Elektronik ve mekanik balastla uyumlu

Material:

- Steel housing
- Zinc frame
- Aluminium reflector
- Semi-frosted glass
- Plated
- Ready for electronic and mechanical gear

Renk:

- Saten Nikel

Colour:

- Satin Nickel



G 24

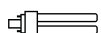

Dulux D / Dulux D-E

2x18 W



Ø177 mm



64x42x25 cm / 12 pcs



Y



IP 20

JD550

**Malzeme:**

- Metal gövde
- Zamak çerçeve
- Alüminyum reflektör
- Kısmi buzlu cam

Material:

- Steel housing
- Zinc frame
- Aluminium reflector
- Semi-frosted glass

Renk:

- Saten Nikel

Colour:

- Satin Nickel

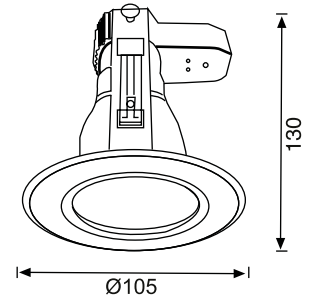

E 27



Spiral

15 W



Ø90 mm



57x24x57 cm / 40 pcs



Y



IP

20

JD532 H

**Malzeme:**

- Metal gövde
- Zamak çerçeve
- Alüminyum reflektör
- Kısmi buzlu cam
- Kaplama

Material:

- Steel housing
- Zinc frame
- Aluminium reflector
- Semi-frosted glass
- Plated

Renk:

- Saten Nikel

Colour:

- Satin Nickel

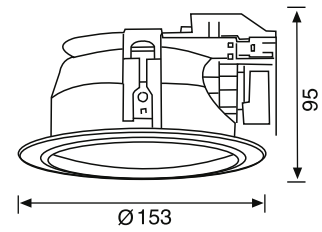

E 27



Spiral

20 W



Ø135 mm



47x34x52 cm / 20 pcs



Y



IP

20

JD551

**Malzeme:**

- Metal gövde
- Zamak çerçeve
- Alüminyum reflektör
- Kısmi buzlu cam
- Kaplama

Material:

- Steel housing
- Zinc frame
- Aluminium reflector
- Semi-frosted glass
- Plated

Renk:

- Saten Nikel

Colour:

- Satin Nickel

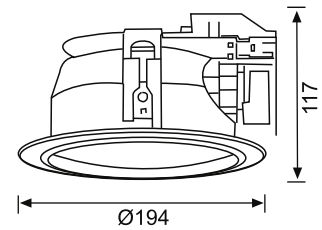

E 27

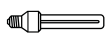

Dulux Star

2x20 W



Ø177 mm



43x43x41 cm / 12 pcs



Y



IP

20

JD568

**Malzeme:**

- Plastik gövde
- Alüminyum reflektör
- Paslanmaz çelik çerçeve
- Elektrostatik toz boyama

Material:

- Plastic housing
- Aluminium reflector
- Stainless steel frame
- Electrostatic powder coated

Renk:

- Paslanmaz Çelik

Colour:

- Stainless Steel

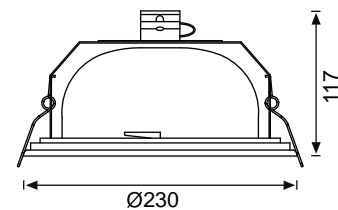

E 27



Dulux Star

2x20 W



Ø205 mm



52x38x52 cm / 12 pcs



Y



IP

20

JD518

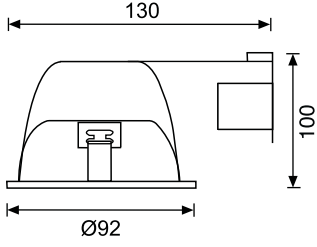
**Malzeme:**

- Metal gövde
- Alüminyum reflektör
- Prizmatik cam
- Kaplama

Material:

- Steel housing
- Aluminium reflector
- Prismatic glass
- Plated

Renk:

- Saten Nikel

Colour:

- Satin Nickel



E 27



Spiral

15 W



Ø85 mm



62x33x53 cm / 50 pcs



Y



IP

20

JD517

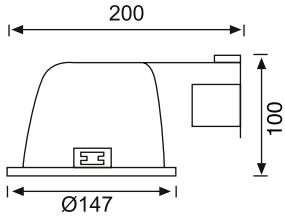
**Malzeme:**

- Metal gövde
- Alüminyum reflektör
- Prizmatik cam
- Kaplama

Material:

- Steel housing
- Aluminium reflector
- Prismatic glass
- Plated

Renk:

- Saten Nikel

Colour:

- Satin Nickel



E 27



Spiral

20 W



Ø134 mm



79.5x42x53 cm / 30 pcs



Y



IP

20

JD519

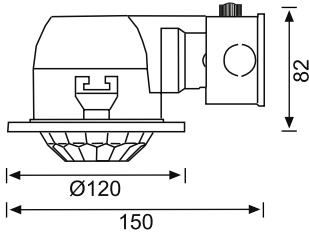
**Malzeme:**

- Metal gövde
- Alüminyum reflektör
- Kristal cam
- Kaplama

Material:

- Steel housing
- Aluminium reflector
- Crystal glass
- Plated

Renk:

- Saten Nikel

Colour:

- Satin Nickel



E 27



Spiral

15 W



Ø100 mm



65.5x33x26.5 cm / 20 pcs



Y



IP

20

JD544

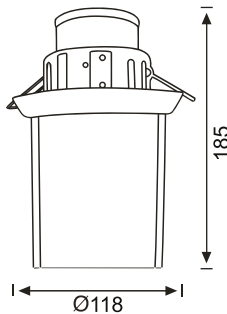
**Malzeme:**

- Metal gövde
- Opal cam
- Kaplama

Material:

- Steel housing
- Opal glass
- Plated

Renk:

- Saten Nikel

Colour:

- Satin Nickel



E 27



Spiral

20 W



Ø90 mm



69.5x29x45.5 cm / 20 pcs



Y



IP

20

JD541



- Malzeme:**
- Metal gövde
 - Alüminyum reflektör
 - Elektrostatik toz boyama

- Material:**
- Steel housing
 - Aluminium reflector
 - Electrostatic powder coated

- Renk:**
- Saten Nikel

- Colour:**
- Satin Nickel

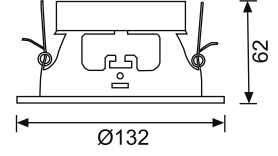

		5 W			Y	IP	20
--	--	-----	--	--	---	----	----

JD540



- Malzeme:**
- Alüminyum enjeksiyon gövde
 - Elektrostatik toz boyama

- Material:**
- Die-cast aluminium housing
 - Electrostatic powder coated

- Renk:**
- Beyaz
 - Saten Nikel

- Colour:**
- White
 - Satin Nickel

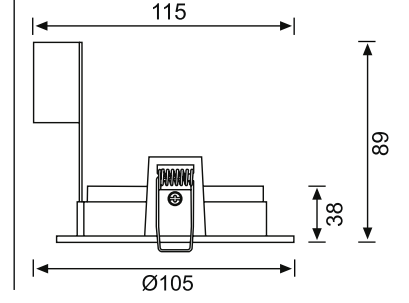

		5 W			Y	IP	20
--	--	-----	--	--	---	----	----

JD556



- Malzeme:**
- Polikarbonat gövde
 - ABS çerçeve

- Material:**
- Polycarbonate housing
 - ABS frame

- Renk:**
- Mat Beyaz

- Colour:**
- Matt White

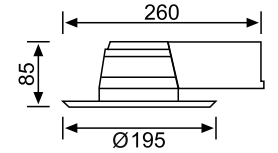

		2x15 W			Y	IP	20
--	--	--------	--	--	---	----	----

JD557



- Malzeme:**
- Polikarbonat gövde
 - ABS çerçeve

- Material:**
- Polycarbonate housing
 - ABS frame

- Renk:**
- Mat Beyaz

- Colour:**
- Matt White

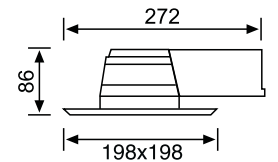

		2x15 W			Y	IP	20
--	--	--------	--	--	---	----	----

JD502

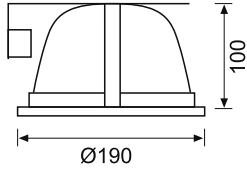
**Malzeme:**

- Metal gövde
- Vakum metalize reflektör
- Elektrostatik toz boyama

Material:

- Steel housing
- Vacuumed metalized reflector
- Electrostatic powder coated

Renk:

- Beyaz

Colour:

- White



G 24

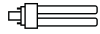

Dulux D

18 W



Ø165 mm



59x42x43 cm / 24 pcs

Y

IP

20

JD504

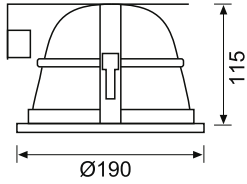
**Malzeme:**

- Metal gövde
- Vakum metalize reflektör
- Buzlu cam
- Elektrostatik toz boyama

Material:

- Steel housing
- Vacuumed metalized reflector
- Frosted glass
- Electrostatic powder coated

Renk:

- Beyaz

Colour:

- White



G 24



Dulux D

2x18 W



Ø165 mm



60x41.5x49 cm / 24 pcs

Y

IP

20

JD501

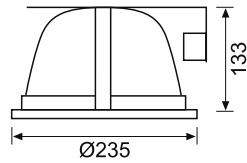
**Malzeme:**

- Alüminyum enjeksiyon gövde
- Alüminyum reflektör
- Elektrostatik toz boyama

Material:

- Die-cast aluminium housing
- Aluminium reflector
- Electrostatic powder coated

Renk:

- Beyaz
- Gümüş Gri

Colour:

- White
- Silver Gray



G 24

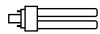

Dulux D

2x26 W



Ø210 mm



53x53x45 cm / 12 pcs

Y

IP

20

JD514

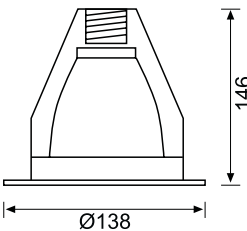
**Malzeme:**

- Alüminyum enjeksiyon gövde
- Alüminyum reflektör
- Şeffaf cam
- Elektrostatik toz boyama

Material:

- Die-cast aluminium housing
- Aluminium reflector
- Clear glass
- Electrostatic powder coated

Renk:

- Gümüş gri

Colour:

- Silver grey



G 24

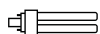

Dulux D

1x13 W



Ø120 mm



47x62x34 cm / 24 pcs

Y

IP

20



LD476



LD477



LD478



LD475

LD476



Malzeme:

- Alüminyum enjeksiyon gövde
- Şeffaf cam difüzör
- Philips veya Osram LED sürücülü 700 mA
- Elektrostatik toz boyama

Material:

- Die-cast aluminium housing
- Clear glass diffuser
- With 700mA Philips or Osram driver
- Electrostatic powder coated

Renk:
• Beyaz

Colour:
• White

Driver options:
PHILIPS
OSRAM

bridgelux. inside

LED

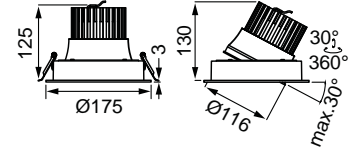

LED Tipi	Renk Sıcaklığı	Işık Akısı	Sistem Gücü	Voltaj	Ø	Beam Angle	Size	Y	IP
Bridgelux COB LED	3000 K	2400 lm	27 W	230 V	Ø155 mm	24°	74x44x33 cm / 16 pcs	Y	IP 20

LD477



Malzeme:

- Alüminyum enjeksiyon gövde
- Şeffaf cam difüzör
- Philips veya Osram LED sürücülü 700 mA
- Elektrostatik toz boyama

Material:

- Die-cast aluminium housing
- Clear glass diffuser
- With 700mA Philips or Osram driver
- Electrostatic powder coated

Renk:
• Beyaz

Colour:
• White

Driver options:
PHILIPS
OSRAM

bridgelux. inside

LED

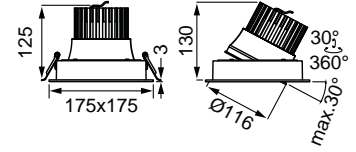

LED Tipi	Renk Sıcaklığı	Işık Akısı	Sistem Gücü	Voltaj	Size	Beam Angle	Size	Y	IP
Bridgelux COB LED	3000 K	2400 lm	27 W	230 V	155x155 mm	24°	74x44x33 cm / 16 pcs	Y	IP 20

LD478



Malzeme:

- Alüminyum enjeksiyon gövde
- Şeffaf cam difüzör
- Philips veya Osram LED sürücülü 700 mA
- Elektrostatik toz boyama

Material:

- Die-cast aluminium housing
- Clear glass diffuser
- With 700mA Philips or Osram driver
- Electrostatic powder coated

Renk:
• Beyaz

Colour:
• White

Driver options:
PHILIPS
OSRAM

bridgelux. inside

LED

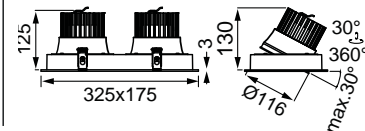

LED Tipi	Renk Sıcaklığı	Işık Akısı	Sistem Gücü	Voltaj	Size	Beam Angle	Size	Y	IP
Bridgelux COB LED	3000 K	4800 lm	2x27 W	230 V	300x155 mm	24°	73x42x31 cm / 8 pcs	Y	IP 20

LD433

LED

SHARP inside

Driver options:

PHILIPS

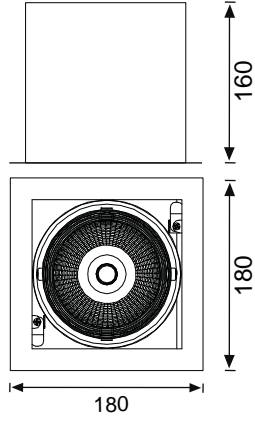
MW
MEAN WELL**Malzeme:**

- Alüminyum enjeksiyon gövde
- Çok yönlü hareketli
- Philips veya Meanwell LED sürücülü 700 mA

Material:

- Die-cast Aluminium housing
- Multi-directional adjustable lamp position
- With 700mA Philips or Meanwell LED driver

Renk:

- Beyaz

Colour:

- White



LED Tipi	Renk Sıcaklığı	Işık Akısı	Sistem Gücü	Voltaj				Y	IP
Sharp COB LED	3000 K	2000 lm	30 W	230V	160x160 mm	24°	48x70x27 cm / 6 pcs		20

LD434

LED

SHARP inside

Driver options:

PHILIPS

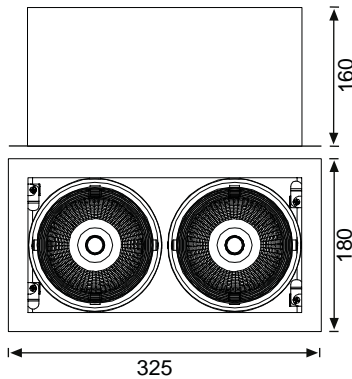
MW
MEAN WELL**Malzeme:**

- Alüminyum enjeksiyon gövde
- Çok yönlü hareketli
- Philips veya Meanwell 700mA LED trafolu

Material:

- Die-cast Aluminium housing
- Multi-directional adjustable lamp position
- With 700mA Philips or Meanwell LED driver

Renk:

- Beyaz

Colour:

- White



LED Tipi	Renk Sıcaklığı	Işık Akısı	Sistem Gücü	Voltaj				Y	IP
Sharp COB LED	3000 K	4000 lm	2x30 W	230V	295x160 mm	24°	48x40x50 cm / 4 pcs		20

JH738



- Malzeme:**
- Alüminyum enjeksiyon gövde
 - Çerçevesiz
- Material:**
- Die-cast Aluminium housing
 - Trimless

- Renk:**
- Siyah
- Colour:**
- Black

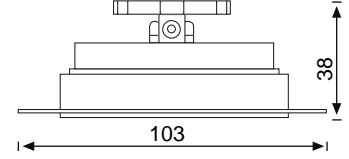

GU 10	LED Par 16	5 W	Ø75 mm	56x23.5x24 cm / 50 pcs	Y	IP 20
-------	------------	-----	--------	------------------------	---	-----------------

LD410



- Malzeme:**
- Alüminyum enjeksiyon gövde
 - Çok yönlü hareketli
 - Elektrostatik toz boyama
 - Philips veya Meanwell LED sürücülü 500mA
 - Çerçevesiz
- Material:**
- Die-cast Aluminium housing
 - Multi-directional adjustable lamp position
 - Electrostatic powder coated
 - With 500mA Philips or Meanwell LED driver
 - Trimless

- Renk:**
- Siyah
- Colour:**
- Black

Driver options:

PHILIPS

MW
MEAN WELL

SHARP inside

LED

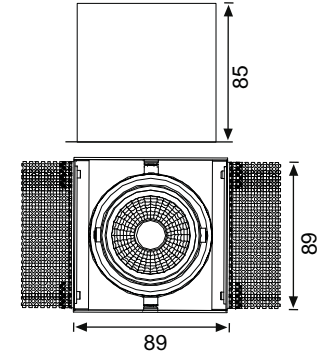

LED Tipi	Renk Sıcaklığı	Işık Akısı	Sistem Gücü	Voltaj	95x95 mm	24°	53x35x23 cm / 12 pcs	Y	IP 20
Sharp COB LED	3000 K	802 lm	11 W	230V					

LD411



- Malzeme:**
- Alüminyum enjeksiyon gövde
 - Çok yönlü hareketli
 - Elektrostatik toz boyama
 - Philips veya Meanwell LED sürücülü 500mA
 - Çerçevesiz
- Material:**
- Die-cast Aluminium housing
 - Multi-directional adjustable lamp position
 - Electrostatic powder coated
 - With 500mA Philips or Meanwell LED driver
 - Trimless

- Renk:**
- Siyah
- Colour:**
- Black

Driver options:

PHILIPS

MW
MEAN WELL

SHARP inside

LED

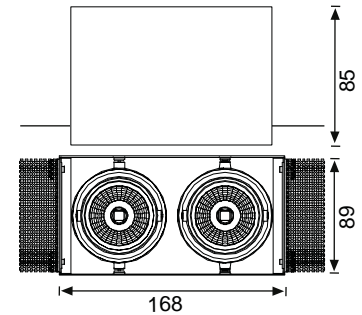

LED Tipi	Renk Sıcaklığı	Işık Akısı	Sistem Gücü	Voltaj	174x95 mm	24°	51.5x28x41 cm / 12 pcs	Y	IP 20
Sharp COB LED	3000 K	1612 lm	2x11 W	230V					

JH739

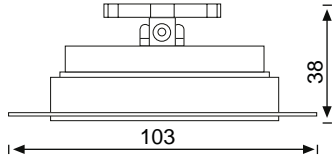
**Malzeme:**

- Alüminyum enjeksiyon gövde
- Çerçevesiz

Renk:
• Siyah**Material:**

- Die-cast Aluminium housing
- Trimless

Colour:
• Black

GU 10



LED Par 16

5 W



75x75 mm



56x23.5x25 cm / 50 pcs

Y

IP

44

LED

SHARP inside

Driver options:

PHILIPS

MW
MEAN WELL**Malzeme:**

- Alüminyum enjeksiyon gövde
- Çok yönlü hareketli
- Elektrostatik toz boyama
- Philips veya Meanwell LED sürücülü 700mA
- Çerçevesiz

Material:

- Die-cast Aluminium housing
- Multi-directional adjustable lamp position
- Electrostatic powder coated
- With 700mA Philips or Meanwell LED driver
- Trimless

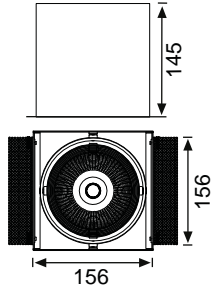
Renk:
• Siyah**Colour:**
• Black

LD435



LED Tipi

Renk Sıcaklığı

Işık Akısı

Sistem Gücü

Voltaj



162x162 mm



24°



48x70x27 cm / 6 pcs

Y

IP

20

Sharp COB LED

3000 K

2270 lm

30 W

230V

LED

SHARP inside

Driver options:

PHILIPS

MW
MEAN WELL**Malzeme:**

- Alüminyum enjeksiyon gövde
- Çok yönlü hareketli
- Elektrostatik toz boyama
- Philips veya Meanwell LED sürücülü 700mA
- Çerçevesiz

Material:

- Die-cast Aluminium housing
- Multi-directional adjustable lamp position
- Electrostatic powder coated
- With 700mA Philips or Meanwell LED driver
- Trimless

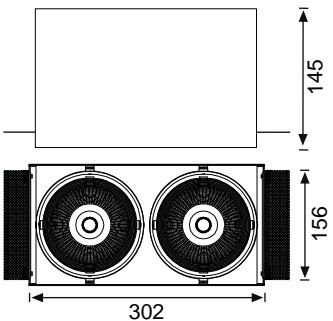
Renk:
• Siyah**Colour:**
• Black

LD436



LED Tipi

Renk Sıcaklığı

Işık Akısı

Sistem Gücü

Voltaj



308x162 mm



24°



48x40x50 cm / 4 pcs

Y

IP

20

Sharp COB LED

3000 K

4542 lm

2x30 W

230V

LD475



Malzeme:

- Alüminyum enjeksiyon gövde
- Opal polikarbonat difüzör
- Philips veya Osram LED sürücülü 700 mA
- Elektrostatik toz boyama

Material:

- Die-cast aluminium housing
- Opal polycarbonate diffuser
- With Philips or Osram 700 mA LED driver
- Electrostatic powder coated

Renk:

- Beyaz

Colour:

- White

Driver options:
PHILIPS
OSRAM

CITIZEN™ inside

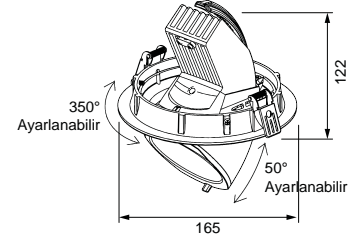

LED Tipi	Renk Sıcaklığı	Işık Akısı	Sistem Gücü	Voltaj	Ø	Y	IP
Citizen COB LED	3000 K	2980 lm	28 W	230 V	Ø150 mm	24°	50x42x41 cm / 12 pcs

JD642



Malzeme:

- Alüminyum enjeksiyon gövde
- Elektrostatik toz boyama
- Çok yönlü hareketli

Material:

- Die-cast aluminium housing
- Electrostatic powder coated
- Multi-directional adjustable lamp position

Renk:

- Beyaz

Colour:

- White

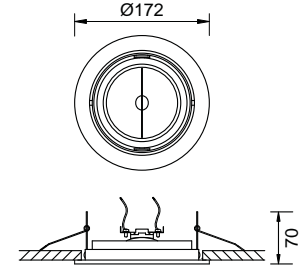

AR111	LA014	30 W	Ø155 mm	56x38x48 cm / 12 pcs	Y	IP
						20

JD617



Malzeme:

- Alüminyum enjeksiyon gövde
- Alüminyum reflektör 30°
- Isıya dayanıklı cam
- Hareketli
- Elektrostatik toz boyama

Material:

- Die-cast aluminium housing
- Aluminium reflector 30°
- Tempered clear glass
- Adjustable lamp position
- Electrostatic powder coated

Renk:

- Beyaz
- Gümüş Gri

Colour:

- White
- Silver Gray

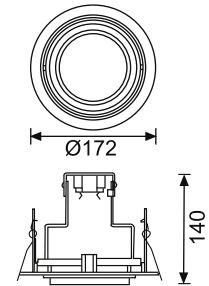

G 12	HQI-T	70 W	Ø155 mm	38x38x47 cm / 12 pcs	Y	IP
						20

JD526

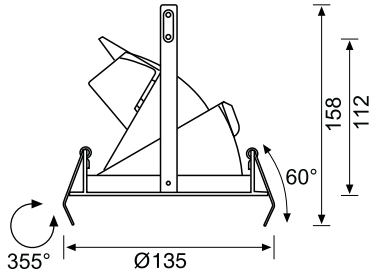
**Malzeme:**

- Alüminyum enjeksiyon gövde
- Alüminyum reflektör 100°
- Isiya dayanıklı cam
- Hareketli
- Elektrostatik toz boyama

Material:

- Die-cast aluminium housing
- Aluminium reflector 100°
- Tempered clear glass
- Adjustable lamp position
- Electrostatic powder coated

Renk:

- Siyah
- Gümüş Gri

Colour:

- Black
- Silver Gray



G 8.5



HCI-TC

35-70 W



Ø126 mm



75x31.5x35.5 cm / 20 pcs

Y

IP

20

JD523

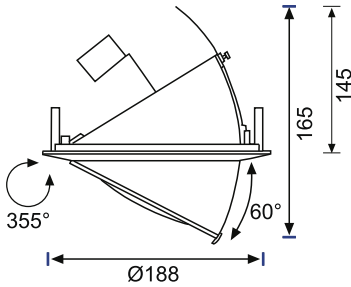
**Malzeme:**

- Alüminyum enjeksiyon gövde
- Alüminyum reflektör 100°
- Isiya dayanıklı oval cam
- Hareketli
- Elektrostatik toz boyama veya kaplama

Material:

- Die-cast aluminium housing
- Aluminium reflector 100°
- Tempered oval glass
- Adjustable lamp position
- Electrostatic powder coated or plated

Renk:

- Krom
- Saten Nikel

Colour:

- Chrome
- Satin Nickel



G 12



HCI-T

70-150 W



Ø173 mm



51x41x41 cm / 12 pcs

Y

IP

20

JD521

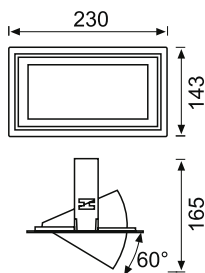
**Malzeme:**

- Alüminyum enjeksiyon gövde
- Alüminyum reflektör
- Isiya dayanıklı cam
- Hareketli
- Elektrostatik toz boyama veya kaplama

Material:

- Die-cast aluminium housing
- Aluminium reflector
- Tempered clear glass
- Adjustable lamp position
- Electrostatic powder coated or plated

Renk:

- Beyaz
- Gümüş Gri
- Krom
- Saten Nikel

Colour:

- White
- Silver Gray
- Chrome
- Satin Nickel



Rx 7s



HQI-TS

150 W



210x125 mm



47x31x42 cm / 12 pcs

Y

IP

20

JD620



Malzeme:

- Metal gövde
- Alüminyum enjeksiyon iç halkalar
- Çok yönlü hareketli
- Elektrostatik toz boyama

Material:

- Steel housing
- Die-cast aluminium inner rings
- Multi-directional adjustable lamp position
- Electrostatic powder coated

Renk:

- Beyaz
- Siyah

Colour:

- White
- Black

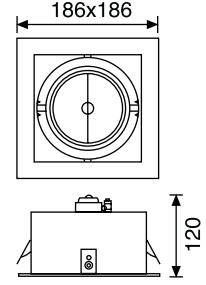

Gx 8.5 / G 53



CDM-R 111 / Halospot 111

70 W / 100 W



163x163 mm



61x43x34 mm / 12 pcs



20

JD621



Malzeme:

- Metal gövde
- Alüminyum reflektör 30°
- Alüminyum enjeksiyon iç halkalar
- Çok yönlü hareketli
- Isıya dayanıklı oval cam
- Elektrostatik toz boyama

Material:

- Steel housing
- Aluminium reflector 30°
- Die-cast aluminium inner rings
- Multi-directional adjustable lamp position
- Tempered oval glass
- Electrostatic powder coated

Renk:

- Beyaz
- Siyah
- Gümüş Gri

Colour:

- White
- Black
- Silver Gray

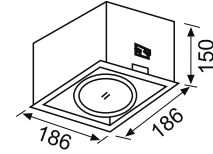

G 12



HCI-T

70 W



163x163 mm



60.5x43x34 cm / 12 pcs



20

JD622



Malzeme:

- Metal gövde
- Alüminyum reflektör 30°
- Alüminyum enjeksiyon iç halkalar
- Çok yönlü hareketli
- Isıya dayanıklı oval cam
- Elektrostatik toz boyama

Material:

- Steel housing
- Aluminium reflector 30°
- Die-cast aluminium inner rings
- Multi-directional adjustable lamp position
- Tempered oval glass
- Electrostatic powder coated

Renk:

- Beyaz
- Siyah
- Gümüş Gri

Colour:

- White
- Black
- Silver Gray

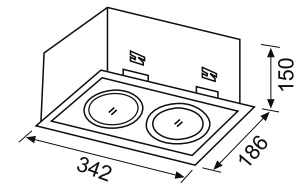

G 12



HCI-T

2x70 W



163x320 mm



63.5x37x34 cm / 6 pcs



20

JD624

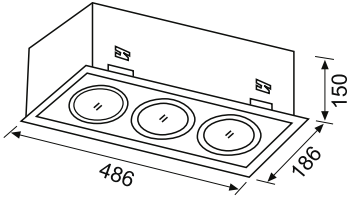
**Malzeme:**

- Alüminyum enjeksiyon gövde
- Alüminyum reflektör 36°
- Isıya dayanıklı cam
- Elektrostatik toz boyama

Material:

- Die-cast aluminium body
- Aluminium reflector 36°
- Tempered glass
- Electrostatic powder coated

Renk:

- Beyaz
- Siyah
- Gümüş Gri

Colour:

- White
- Black
- Silver Grey



G 12



HCI-T

3x70 W



163x460 mm



37x41x52 cm / 6 pcs

Y

IP

20

JD623

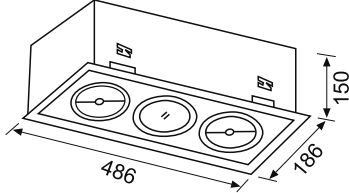
**Malzeme:**

- Metal gövde
- Alüminyum reflektör 30°
- Alüminyum enjeksiyon iç halkalar
- Çok yönlü hareketli
- Isıya dayanıklı oval cam
- Elektrostatik toz boyama

Material:

- Steel housing
- Aluminium reflector 30°
- Die-cast aluminium inner rings
- Multi-directional adjustable lamp position
- Tempered oval glass
- Electrostatic powder coated

Renk:

- Beyaz
- Siyah
- Gümüş Gri

Colour:

- White
- Black
- Silver Gray



G 12 / G 53



HQL-T / Halospot 111

70 W / 2x100 W



163x460 mm



63.5x51.5x34 cm / 6 pcs

Y

IP

20

JD639

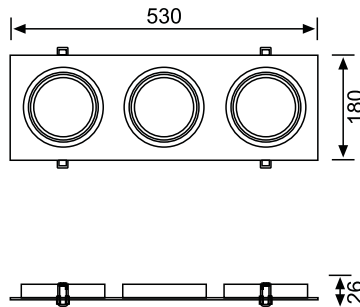
**Malzeme:**

- Alüminyum gövde
- Çok yönlü hareketli

Material:

- Aluminium housing
- Multi-directional adjustable lamp position

Renk:

- Saten Alüminyum & CD

Colour:

- Satin Aluminium & CD



Gx 8.5 / G 53



CDM-R 111 / Halospot 111

3x70 W / 3x100 W



150x500 mm



55x44.5x29 cm / 12 pcs

Y

IP

20

JD570



Malzeme:

- Metal gövde
- Çok yönlü hareketli
- Elektrostatik toz boyama

Material:

- Steel housing
- Multi-directional adjustable lamp position
- Electrostatic powder coated

Renk:

- Mat Beyaz

Colour:

- Matt White

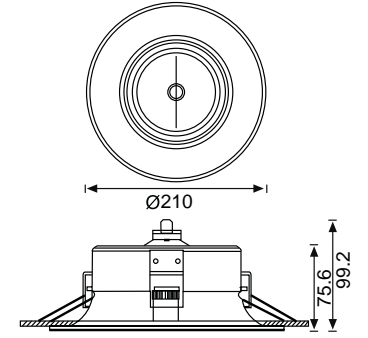

G 53



Halospot 111

100 W



Ø165 mm



52x45x45 cm / 20 pcs



20

JD566



Malzeme:

- Alüminyum gövde
- Çok yönlü hareketli
- Elektrostatik toz boyama

Material:

- Aluminium housing
- Multi-directional adjustable lamp position
- Electrostatic powder coated

Renk:

- Mat Beyaz

Colour:

- Matt White

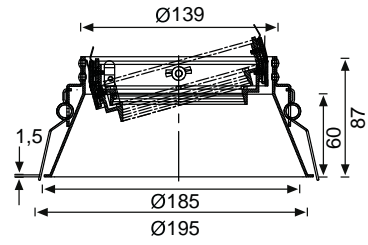

G 53



Halospot 111

100 W



Ø188 mm



54.5x37x37.5 cm / 18 pcs



20

JD643



Malzeme:

- Alüminyum enjeksiyon gövde
- Elektrostatik toz boyama

Material:

- Die-cast aluminium housing
- Electrostatic powder coated

Renk:

- Beyaz

Colour:

- White

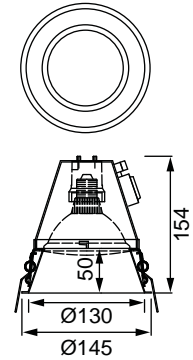

E 27



Halopar 30 / LED Par 30

75 W



Ø136 mm



53x36x40 cm / 12 pcs



20

JD641



Malzeme:

- Alüminyum enjeksiyon gövde
- Elektrostatik toz boyama

Material:

- Die-cast aluminium housing
- Electrostatic powder coated

Renk:

- Beyaz

Colour:

- White

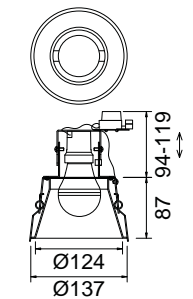

E 27



LED Classic A

10 W



Ø128 mm



44x30x36 cm / 12 pcs



20

JD635

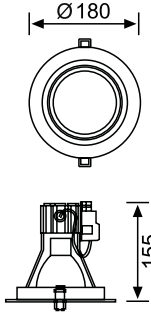
**Malzeme:**

- Alüminyum gövde
- Alüminyum reflektör
- Çok yönlü hareketli
- Isiya dayanıklı cam

Material:

- Aluminium housing
- Aluminium reflector
- Multi-directional adjustable lamp position
- Tempered glass

Renk:

- Saten
- Alüminyum & CD

Colour:

- Satin Aluminium & CD



G 12



HCI-T

70 W



Ø150 mm



56.5x38x33 cm / 12 pcs



20

JD525

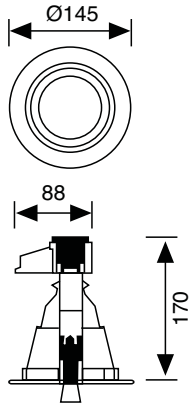
**Malzeme:**

- Alüminyum reflektör
- Isiya dayanıklı cam
- Elektrostatik toz boyama

Material:

- Aluminium reflector
- Tempered glass
- Electrostatic powder coated

Renk:

- Beyaz

Colour:

- White



G 12



HCI-T

70 W



Ø130 mm



48.5x36x42 cm / 12 pcs



20

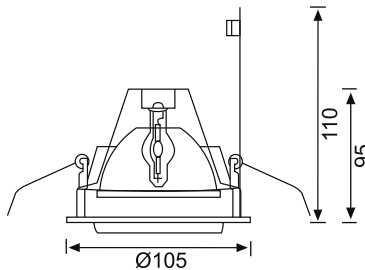

JD616

**Malzeme:**

- Alüminyum enjeksiyon gövde
- Alüminyum reflektör 36°
- Dahili elektronik balast
- Isiya dayanıklı cam
- Çok yönlü hareketli
- Elektrostatik toz boyama
- Ampullü

Material:

- Die-cast aluminium housing
- Aluminium reflector 36°
- Built-in electronic ballast
- Tempered glass
- Multi-directional adjustable lamp position
- Electrostatic powder coated
- Supplied with suitable lamp

Renk:

- Beyaz
- Siyah
- Gümüş Gri

Colour:

- White
- Black
- Silver Gray



PGJ5



CDM-Tm

20 W



Ø98 mm



38x38x47 cm / 50 pcs



20

JR009



BESLEME / LIVE FEED
• 16A

Renk:
• Beyaz
• Siyah
• Gümüş Gri

Colour:
• White
• Black
• Silver Gray

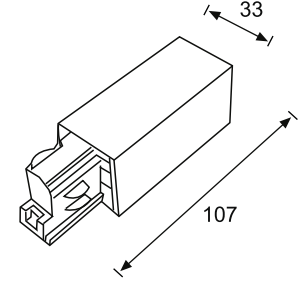

Y

61x10x18 cm / 10/100 pcs

JR010



BAĞLANTI EKİ / CONNECTOR
• + bağlantı eki
• Cross connector

Renk:
• Beyaz
• Siyah
• Gümüş Gri

Colour:
• White
• Black
• Silver Gray

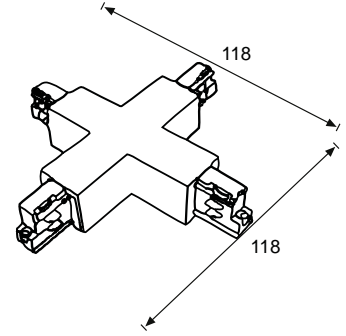

Y

32x24x24 cm / 10/50 pcs

JR008



TAPA / END CAP

Renk:
• Beyaz
• Siyah
• Gümüş Gri

Colour:
• White
• Black
• Silver Gray

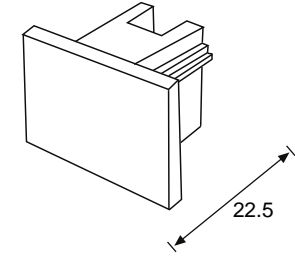

Y

22.5x21.5x22.5 cm / 10/100 pcs

JR002 / JR007



RAY / TRACK
• Trifaze ray
• 16 A
• Max: 5 kg

• Three circuit track
• 16 A
• Max: 5 kg

Renk:
• Beyaz
• Siyah
• Gümüş Gri

Colour:
• White
• Black
• Silver Gray

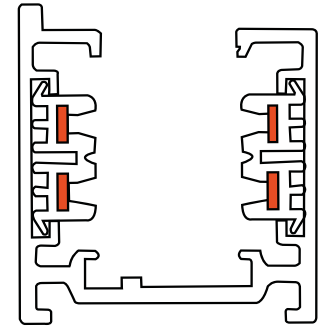

2000 / 3000



Y

202x16x16 cm / 12 pcs - 302x16x12 cm / 8 pcs

JR003

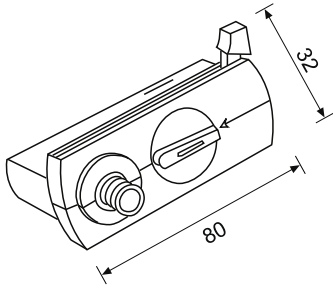
**ADAPTÖR / ADAPTOR**

- 6A, 230 V
- Max: 2 kg

Renk:

- Beyaz
- Siyah
- Gümüş Gri

Colour:

- White
- Black
- Silver Gray



Y

53x19x22 cm / 10/100 pcs

JR004

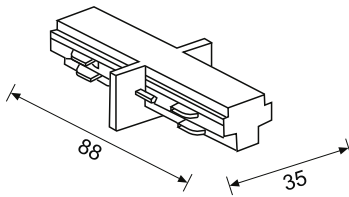
**BAĞLANTI EKİ / CONNECTOR**

- Düz bağlantı eki
- Straight connector

Renk:

- Beyaz
- Siyah
- Gümüş Gri

Colour:

- White
- Black
- Silver Gray



Y

55x18x19 cm / 10/100 pcs

JR005

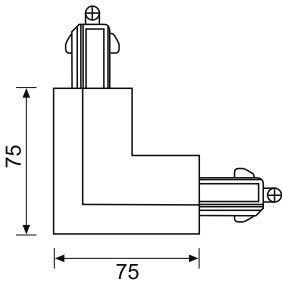
**BAĞLANTI EKİ / CONNECTOR**

- L şeklinde 90°
- Dış taraftan topraklama

- L connector 90°
- Grounding outside

Renk:

- Beyaz
- Siyah
- Gümüş Gri

Colour:

- White
- Black
- Silver Gray



Y

32x24x24 cm / 10/100 pcs

JR006

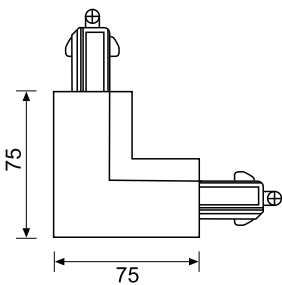
**BAĞLANTI EKİ / CONNECTOR**

- L şeklinde 90°
- İç taraftan topraklama

- L connector 90°
- Grounding inside

Renk:

- Beyaz
- Siyah
- Gümüş Gri

Colour:

- White
- Black
- Silver Gray



Y

32x24x24 cm / 10/100 pcs



JR657



LR464

LR461



Malzeme:

- Alüminyum gövde
- Osram Element sürücülü 900 mA
- Elektrostatik toz boyama

Material:

- Aluminium housing
- 900 mA Osram Element driver included
- Electrostatic powder coated

Renk:

- Beyaz

Colour:

- White

Driver options:



CITIZEN™ inside

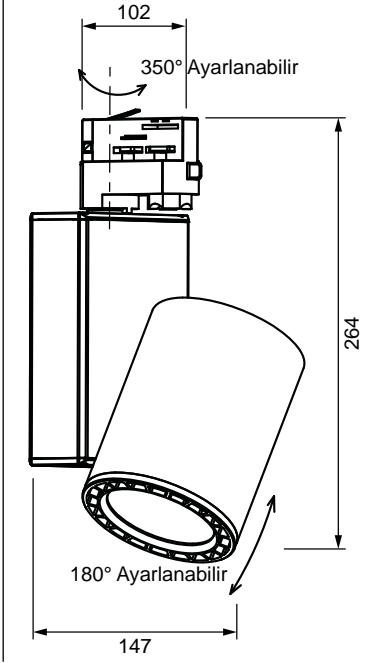

LED Tipi	Renk Sıcaklığı	Işık Akısı	Sistem Gücü	Voltaj	24°	58x38x35 cm / 12 pcs	Y	IP 20
Citizen COB LED	3000 K	2600 lm	36 W	230 V				

LR462



Malzeme:

- Alüminyum gövde
- Osram Element sürücülü 900 mA
- Elektrostatik toz boyama

Material:

- Aluminium housing
- 900 mA Osram Element driver included
- Electrostatic powder coated

Renk:

- Siyah

Colour:

- Black

Driver options:



CITIZEN™ inside

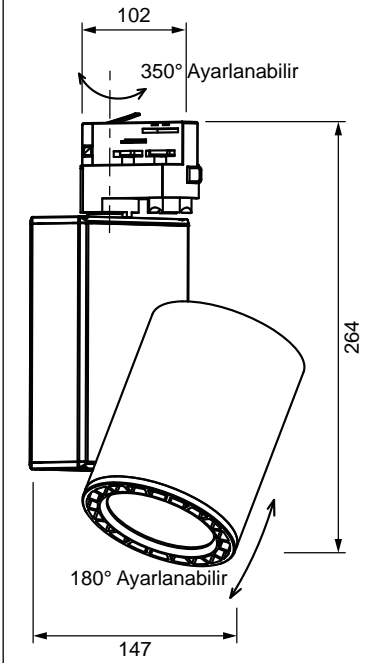

LED Tipi	Renk Sıcaklığı	Işık Akısı	Sistem Gücü	Voltaj	24°	58x38x35 cm / 12 pcs	Y	IP 20
Citizen COB LED	3000 K	2600 lm	36 W	230 V				

LED

PHILIPS inside

Driver options:

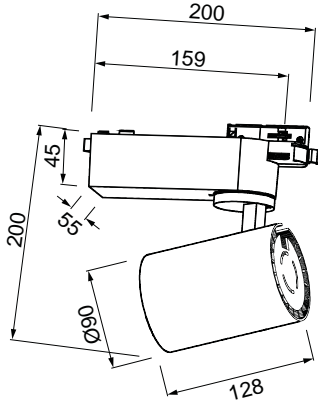

LR459

**Malzeme:**

- Alüminyum gövde
- Philips Luxen Gen 2 COB LED
- Osram OTE35 sürücüsü 800 mA

Material:

- Aluminium housing
- Philips Luxen Gen 2 COB LED
- 800 mA Osram OTE35 driver included

Renk:

- Mat Beyaz

Colour:

- Matt White

LED Tipi	Renk Sıcaklığı	Işık Akısı	Sistem Gücü	Voltaj
Philips COB LED	3000 K	2630 lm	33 W	230 V

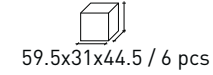

Y

IP
20

LED

PHILIPS inside

Driver options:

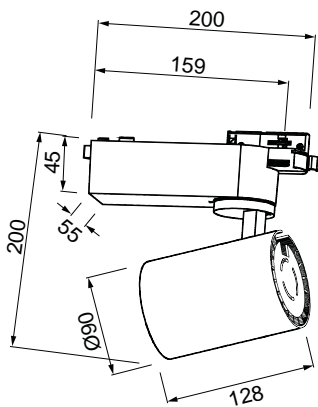

LR460

**Malzeme:**

- Alüminyum gövde
- Philips Luxen Gen 2 COB LED
- Osram OTE35 sürücüsü 800 mA

Material:

- Aluminium housing
- Philips Luxen Gen 2 COB LED
- 800 mA Osram OTE35 driver included

Renk:

- Mat Siyah

Colour:

- Matt Black

LED Tipi	Renk Sıcaklığı	Işık Akısı	Sistem Gücü	Voltaj
Philips COB LED	3000 K	2630 lm	33 W	230 V

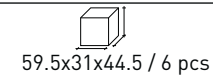

Y

IP
20

JR657



Malzeme:

- Tek faz ray soketli
- Alüminyum gövde
- Elektrostatik toz boyama

Material:

- With single phase track adapter
- Aluminium housing
- Electrostatic powder coated

- Renk:**
- Beyaz
 - Siyah

- Colour:**
- White
 - Black

NEW

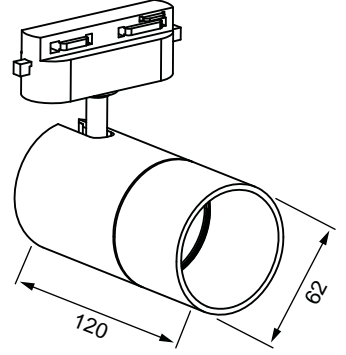

GU10



LED Par 16

5 W



37,5x32x26 cm / 24 pcs

Y

IP

20

JR656



Malzeme:

- Tek faz ray soketli
- Alüminyum gövde
- Elektrostatik toz boyama

Material:

- With single phase track adapter
- Aluminium housing
- Electrostatic powder coated

- Renk:**
- Beyaz
 - Siyah

- Colour:**
- White
 - Black

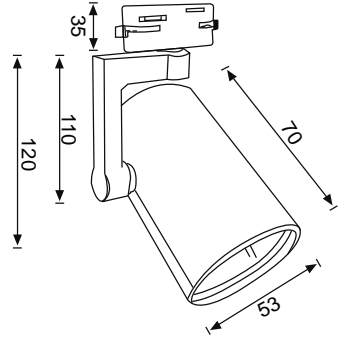

E 27



Halopar 30 /LED Par 30

75 W



46x33x35.5 cm / 40 pcs

Y

IP

20

JR655



Malzeme:

- Tek faz ray soketli
- Alüminyum gövde
- Elektrostatik toz boyama

Material:

- With single phase track adapter
- Aluminium housing
- Electrostatic powder coated

- Renk:**
- Beyaz
 - Siyah

- Colour:**
- White
 - Black

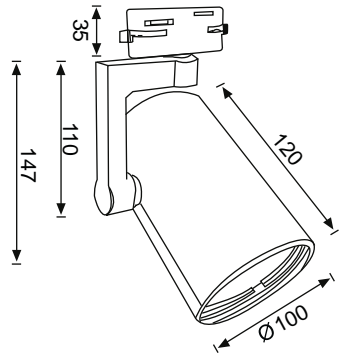

E 27



Halopar 30 /LED Par 30

75 W



54x36.5x53.5 cm / 24 pcs

Y

IP

20

LED **NEW**

LR464

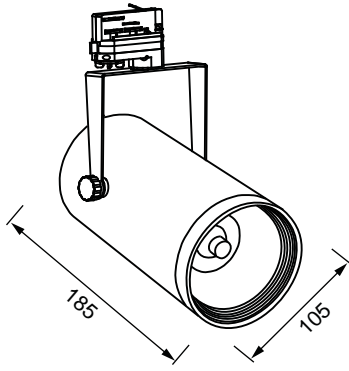
**Malzeme:**

- Alüminyum enjeksiyon gövde
- Alüminyum reflektör 24°
- Dahili LED sürücülü
- Elektrostatik toz boyama
- Tek faz ray soketli

Material:

- Die-cast aluminium housing
- Aluminium reflector 24°
- Built-in LED driver
- Electrostatic powder coated
- With single phase track adapter

Renk:

- Beyaz

Colour:

- White

LED Tipi	Renk Sıcaklığı	Işık Akısı	Sistem Gücü	Voltaj
COB LED	3000 K	1800 lm	25 W	230 V



24°



45.5x39.5x29.5 cm / 8 pcs

Y

IP
20LED **NEW**

LR463

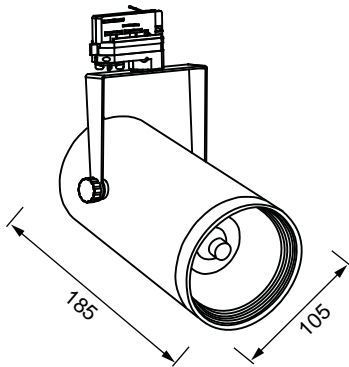
**Malzeme:**

- Alüminyum enjeksiyon gövde
- Alüminyum reflektör 24°
- Dahili LED sürücülü
- Elektrostatik toz boyama
- Tek faz ray soketli

Material:

- Die-cast aluminium housing
- Aluminium reflector 24°
- Built-in LED driver
- Electrostatic powder coated
- With single phase track adapter

Renk:

- Siyah

Colour:

- Black

LED Tipi	Renk Sıcaklığı	Işık Akısı	Sistem Gücü	Voltaj
COB LED	3000 K	1800 lm	25 W	230 V



24°



45.5x39.5x29.5 cm / 8 pcs

Y

IP
20

JR646



Malzeme:

- Alüminyum enjeksiyon gövde
- Alüminyum reflektör 36°
- Isıya dayanıklı cam
- Balastsız
- Elektrostatik toz boyama

Material:

- Die-cast aluminium body
- Aluminium reflector 36°
- Tempered glass
- Without ballast
- Electrostatic powder coated

Renk:

- Beyaz
- Siyah

Colour:

- White
- Black

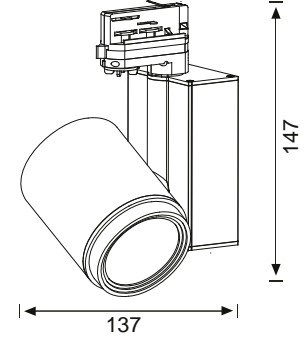

G 12



HCI-T

70 W



57x27x23 cm / 6 pcs

Y

IP

20

JR649



Malzeme:

- Alüminyum enjeksiyon gövde
- Alüminyum reflektör 24°
- Isıya dayanıklı cam
- Balastsız
- Elektrostatik toz boyama

Material:

- Die-cast aluminium body
- Aluminium reflector 24°
- Tempered glass
- Without ballast
- Electrostatic powder coated

Renk:

- Siyah

Colour:

- Black

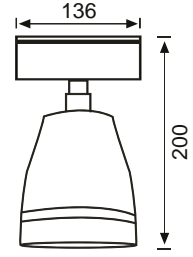

G 12



HCI-T

70 W



Ø125



44x29.5x23.8 cm / 6 pcs

Y

IP

20

JR644



Malzeme:

- Alüminyum gövde
- Metal çerçeve
- Alüminyum reflektör 60°
- Isıya dayanıklı cam
- Dahili balast ve ateşleyici
- Elektrostatik toz boyama

Material:

- Aluminium housing
- Metal frame
- Aluminium reflector 60°
- Tempered clear glass
- Built-in suitable gear
- Electrostatic powder coated

Renk:

- Gümüş Gri

Colour:

- Silver Gray

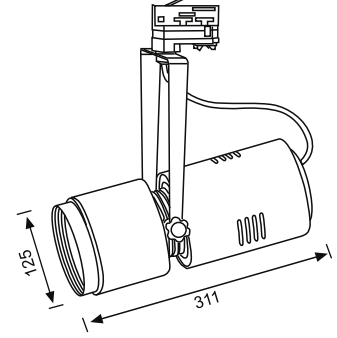

G 12



HCI-T

150 W



60.5x45.5x34.5 cm / 6 pcs

Y

IP

20

JR645



Malzeme:

- Alüminyum gövde
- Metal çerçeve
- Dahili elektronik trafo
- Elektrostatik toz boyama

Material:

- Aluminium housing
- Metal frame
- Built-in electronic transformer
- Electrostatic powder coated

Renk:

- Beyaz
- Gümüş Gri

Colour:

- White
- Silver Gray

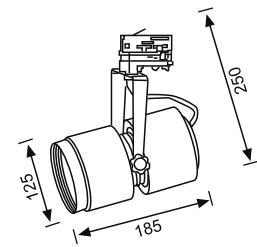

electronic



G 53



Halospot 111

100 W



60.5x45.5x34.5 cm / 6 pcs

Y

IP

20

JR652

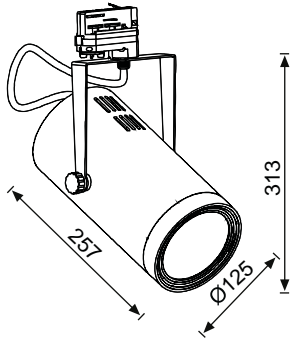
**Malzeme:**

- Alüminyum gövde
- Alüminyum reflektör 24°
- Isiya dayanıklı cam
- Balastsız
- Elektrostatik toz boyama

Material:

- Aluminium housing
- Aluminium reflector 24°
- Tempered glass
- Without ballast
- Electrostatic powder coated

Renk:

- Beyaz
- Siyah

Colour:

- White
- Black



G 12



HCI-T

70 W



40.7x39.5x51 cm / 6 pcs

Y

IP

20

JR654

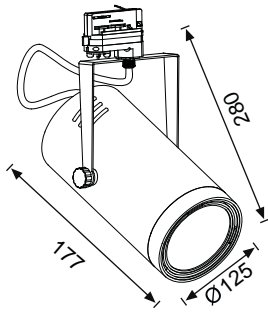
**Malzeme:**

- Alüminyum gövde
- Elektrostatik toz boyama

Material:

- Aluminium housing
- Electrostatic powder coated

Renk:

- Beyaz
- Siyah

Colour:

- White
- Black



E 27



Halopar 30/LED Par 30

75 W



34x40x51 cm / 6 pcs

Y

IP

20

N electronic

JR024

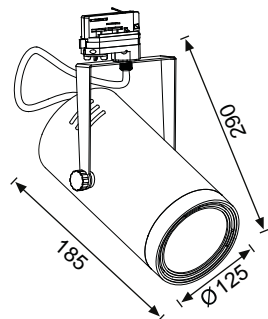
**Malzeme:**

- Alüminyum gövde
- Dahili elektronik trafo
- Elektrostatik toz boyama

Material:

- Aluminium housing
- Built-in electronic transformer
- Electrostatic powder coated

Renk:

- Beyaz
- Siyah

Colour:

- White
- Black



E 53



Halospot 111

100 W



34x40x51 cm / 6 pcs

Y

IP

20

JR011



Malzeme:

- Alüminyum enjeksiyon gövde
- Çok yönlü hareketli
- Dahili elektronik balast
- Elektrostatik toz boyama

Material:

- Die-cast aluminium housing
- Multi-directional adjustable lamp position
- Built-in electronic ballast
- Electrostatic powder coated

Renk:

- Beyaz
- Siyah
- Gümüş Gri

Colour:

- White
- Black
- Silver Gray

electronic

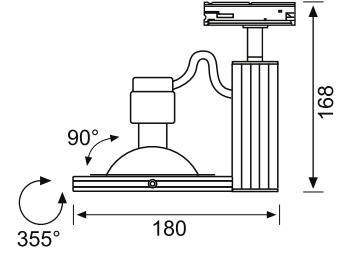

Gx 8.5

CDM-R 111

70 W

61x40x28 cm / 8 pcs

Y

IP

20

JR012



Malzeme:

- Alüminyum enjeksiyon gövde
- Alüminyum reflektör 36°
- Isıya dayanıklı cam
- Dahili elektronik balast
- Elektrostatik toz boyama

Material:

- Die-cast aluminium body
- Aluminium reflector 36°
- Tempered glass
- Built-in electronic ballast
- Electrostatic powder coated

Renk:

- Beyaz
- Siyah
- Gümüş Gri

Colour:

- White
- Black
- Silver Gray

electronic

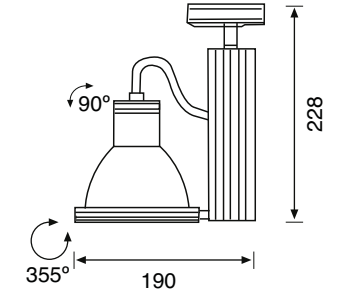

G 12

HQI-T

70 W

79x44x29 cm / 10 pcs

Y

IP

20

JR023



Malzeme:

- Alüminyum enjeksiyon gövde
- Çok yönlü hareketli
- Dahili elektronik trafo
- Elektrostatik toz boyama

Material:

- Die-cast aluminium housing
- Multi-directional adjustable lamp position
- Built-in electronic transformer
- Electrostatic powder coated

Renk:

- Beyaz
- Gümüş Gri

Colour:

- White
- Silver Gray

electronic

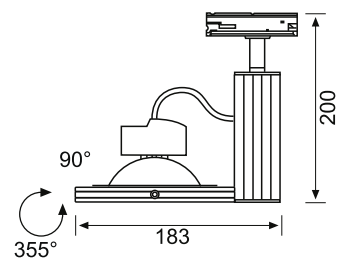

G 53

Halospot 111

100 W

61x22x51 cm / 8 pcs

Y

IP

20

JR022



Malzeme:

- Alüminyum enjeksiyon gövde
- Çok yönlü hareketli
- Dahili elektronik trafo
- Elektrostatik toz boyama

Material:

- Die-cast aluminium housing
- Multi-directional adjustable lamp position
- Built-in electronic transformer
- Electrostatic powder coated

Renk:

- Beyaz
- Gümüş Gri

Colour:

- White
- Silver Gray

electronic

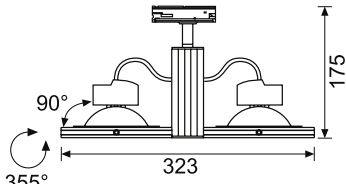

G 53

Halospot 111

2x50 W

61x36x51 cm / 8 pcs

Y

IP

20

N electronic

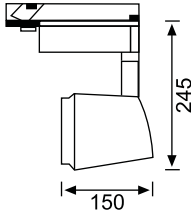
**Malzeme:**

- Alüminyum enjeksiyon gövde
- Alüminyum reflektör 36°
- Isıya dayanıklı cam
- Dahili elektronik balast
- Elektrostatik toz boyama

Material:

- Die-cast aluminium body
- Aluminium reflector 36°
- Tempered glass
- Built-in electronic ballast
- Electrostatic powder coated

Renk:

- Beyaz
- Siyah
- Gümüş Gri

Colour:

- White
- Black
- Silver Gray

JR016



G 12

HCI-T

70 W

56x34.5x43 cm / 6 pcs

Y

IP

20

N electronic

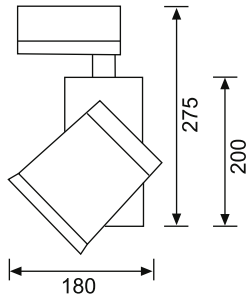
**Malzeme:**

- Alüminyum enjeksiyon gövde
- Dahili elektronik balast
- Elektrostatik toz boyama

Material:

- Die-cast aluminium body
- Built-in electronic ballast
- Electrostatic powder coated

Renk:

- Beyaz
- Gümüş Gri

Colour:

- White
- Silver Gray

JR014



Gx8.5

CDM-R111

70 W

42x32x60 cm / 8 pcs

Y

IP

20

N electronic

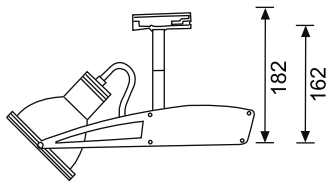
**Malzeme:**

- Alüminyum enjeksiyon gövde
- Alüminyum reflektör 36°
- Isıya dayanıklı cam
- Dahili elektronik balast
- Elektrostatik toz boyama

Material:

- Die-cast aluminium body
- Aluminium reflector 36°
- Tempered glass
- Built-in electronic ballast
- Electrostatic powder coated

Renk:

- Gümüş Gri

Colour:

- Silver Gray

JR031



G 12

HQI-T

70 W

46x36x62 cm / 4 pcs

Y

IP

20

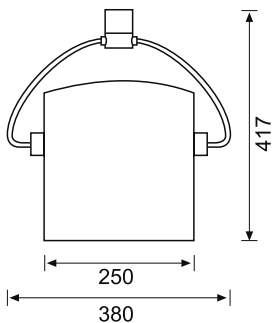
**Malzeme:**

- Alüminyum enjeksiyon gövde
- Alüminyum reflektör
- Isıya dayanıklı cam
- Dahili balast ve ateşleyici
- Elektrostatik toz boyama

Material:

- Die-cast aluminium housing
- Aluminium reflector
- Tempered glass
- Built in suitable gear
- Electrostatic powder coated

Renk:

- Gümüş Gri

Colour:

- Silver Gray

JW640



Rx 7s

HQI-TS

150 W

47x45x58.5 cm / 4 pcs

Y

IP

20

JM010



Malzeme:

- Anahtarlı, ısıya dayanıklı plastik gövde
- Alüminyum reflektör
- Metal kollar
- Tabla ve mingeneli
- Ampüllü

Material:

- Heat-resistant plastic housing with switch
- Aluminium reflector
- Steel arms
- With base and clamp
- With suitable lamp

Renk:
• Siyah

Colour:
• Black

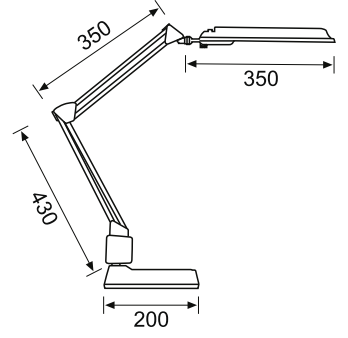

G 23



Dulux S

11 W



41x52x45.5 cm / 6 pcs

Y

IP

20

JM011



Malzeme:

- Anahtarlı, ısıya dayanıklı plastik gövde
- Metal kollar
- Tabla ve mingeneli

Material:

- Heat-resistant plastic housing with switch
- Steel arms
- With base and clamp

Renk:
• Gümüş gri & Siyah

Colour:
• Silver & Black

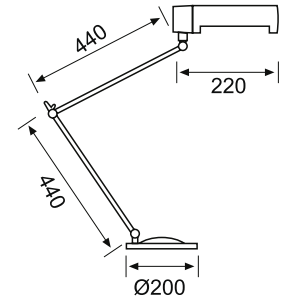

E 27



Dulux Star

20 W



45x32x49.5 cm / 6 pcs

Y

IP

20

LED

EPISTAR inside

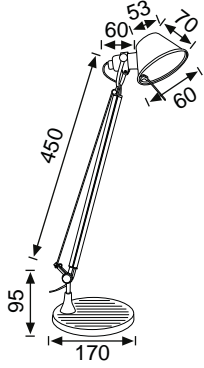
**Malzeme:**

- Alüminyum gövde
- Anahtarlı
- Tablalı

Material:

- Aluminium housing
- With switch
- With base

Renk:

- Gümüş gri

Colour:

- Silver Gray



JM017

LED Tipi

Epistar COB LED

Renk Sıcaklığı

3000 K

Sistem Gücü

5 W

Voltaj

230 V



38x37x57 cm / 6 pcs

Y

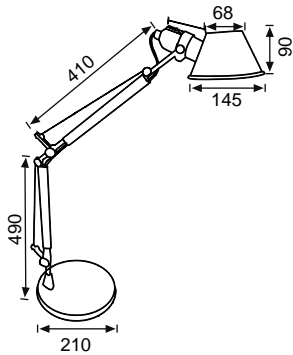
IP
20**Malzeme:**

- Alüminyum gövde
- Anahtarlı
- Tablalı

Material:

- Aluminium housing
- With switch
- With base

Renk:

- Gümüş Gri

Colour:

- Silver Gray



JM015



E 27



Spiral

12 W



47x33x51.5 cm / 4 pcs

Y

IP
20

Venezia V3

**Malzeme:**

- Alüminyum enjeksiyon gövde
- Alüminyum reflektör
- Isıya dayanıklı cam
- Elektrostatik toz boyama
- Tridonic LED sürücülü 180 mA

Material:

- Die-cast aluminium housing
- Aluminium reflector
- Tempered clear glass
- Electrostatic powder coated
- With Tridonic LED driver 180 mA

Renk:

- Beyaz

Colour:

- White

Driver options:
TRIDONIC

CITIZEN™ inside

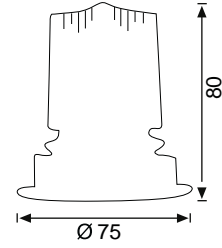

LED Tipi	Renk Sıcaklığı	Işık Akısı	Sistem Gücü	Voltaj	Ø	Y	Y	IP
Citizen COB LED	3000 K	570 lm	8 W	230V	Ø67 mm	36°	41.5x31.5x31 cm / 36 pcs	65

Venezia V7

**Malzeme:**

- Alüminyum enjeksiyon gövde
- Alüminyum reflektör
- Isıya dayanıklı cam
- Elektrostatik toz boyama
- Tridonic LED sürücülü 350 mA

Material:

- Die-cast aluminium housing
- Aluminium reflector
- Tempered clear glass
- Electrostatic powder coated
- With Tridonic LED driver 350 mA

Renk:

- Beyaz

Colour:

- White

Driver options:
TRIDONIC

CITIZEN™ inside

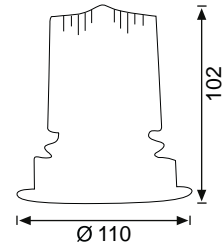

LED Tipi	Renk Sıcaklığı	Işık Akısı	Sistem Gücü	Voltaj	Ø	Y	Y	IP
Citizen COB LED	3000 K	1180 lm	14 W	230V	Ø102 mm	36°	42x42x38.5 cm / 27 pcs	65

Venezia V30

**Malzeme:**

- Alüminyum enjeksiyon gövde
- Alüminyum reflektör
- Isıya dayanıklı cam
- Elektrostatik toz boyama
- Philips LED sürücülü 1050 mA

Material:

- Die-cast aluminium housing
- Aluminium reflector
- Tempered clear glass
- Electrostatic powder coated
- With Philips LED driver 1050 mA

Renk:

- Beyaz

Colour:

- White

Driver options:
PHILIPS

CITIZEN™ inside

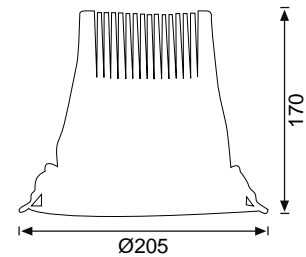

LED Tipi	Renk Sıcaklığı	Işık Akısı	Sistem Gücü	Voltaj	Ø	Y	Y	IP
Citizen COB LED	3000 K	3740 lm	45 W	230V	Ø192 mm	30°	46x46x38 cm / 8 pcs	65

LED

CITIZEN™ inside

Driver options:
TRIDONIC

Brescia

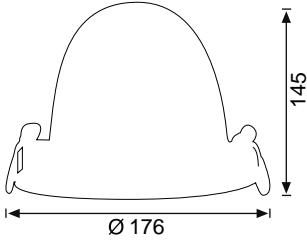
**Malzeme:**

- Alüminyum enjeksiyon gövde
- Alüminyum reflektör
- Isıya dayanıklı cam
- Hareketli
- Elektrostatik toz boyama
- Tridonic LED sürücülü 1400 mA

Material:

- Die-cast aluminium housing
- Aluminium reflector
- Tempered clear glass
- Adjustable lamp position
- Electrostatic powder coated
- With Tridonic LED driver 1400 mA

Renk:

- Beyaz

Colour:

- White

LED Tipi	Renk Sıcaklığı	Işık Akısı	Sistem Gücü	Voltaj	Ø170 mm	36°	41x39x35 cm / 8 pcs	Y	IP 44
Citizen COB	3000 K	6000 lm	60 W	230V					

LED

CITIZEN™ inside

Driver options:
TRIDONIC

Parma

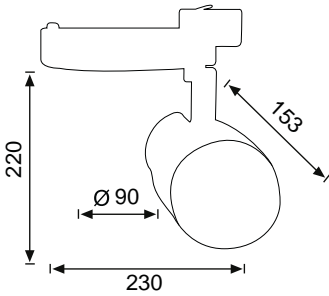
**Malzeme:**

- Alüminyum enjeksiyon gövde
- Alüminyum reflektör
- Isıya dayanıklı cam
- Elektrostatik toz boyama
- Tridonic LED sürücülü 1400 mA

Material:

- Die-cast aluminium housing
- Aluminium reflector
- Tempered clear glass
- Electrostatic powder coated
- With Tridonic LED driver 1400 mA

Renk:

- Beyaz

Colour:

- White

LED Tipi	Renk Sıcaklığı	Işık Akısı	Sistem Gücü	Voltaj	24°	50x27x40 cm / 6 pcs	Y	IP 44
Citizen COB	3000 K	6000 lm	60 W	230V				

60160
60190

LED

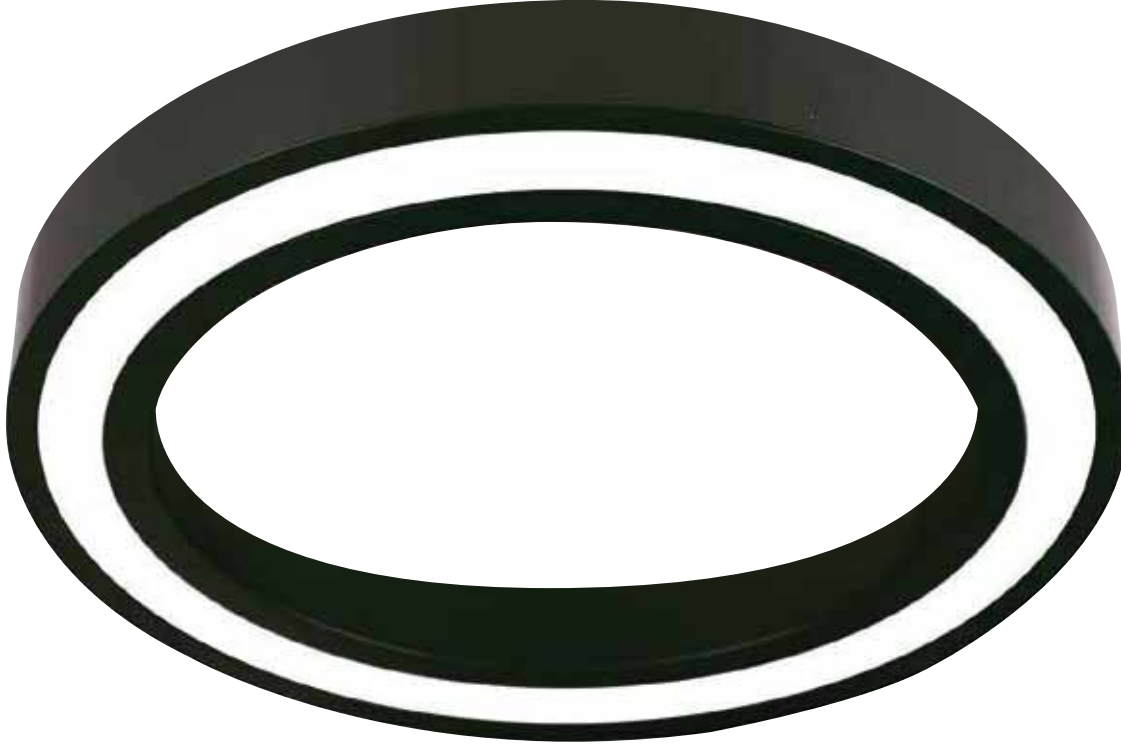
**Malzeme:**

- Alüminyum çekme gövde
- Pleksiglas difüzör
- Dahili LED sürücülü
- Elektrostatik toz boyama
- Sarkit olabilir

Material:

- Aluminium extruded housing
- Plexiglass diffuser
- Built-in LED driver
- Electrostatic powder coated
- Suspended available

Renk:

- Gümüş gri
- Siyah
- Beyaz
- Sarı

Colour:

- Silver
- Black
- White
- Yellow

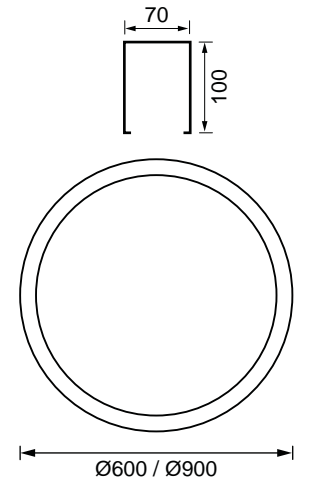

Kod	LED Tipi	Renk Sıcaklığı	Işık Akısı	Sistem Gücü	Voltaj	L	▲	☐	IP
60160	SMD LED	3000 K / 4000 K	2000 lm	24 W	220V	60 cm	120°	1 pc	20
60190	SMD LED	3000 K / 4000 K	4000 lm	48 W	220V	90 cm	120°	1 pc	

60060

LED

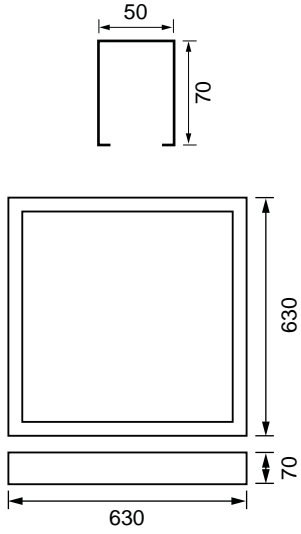
**Malzeme:**

- Alüminyum çekme gövde
- Pleksiglas difüzör
- Dahili LED sürücülü
- Elektrostatik toz boyama
- Sarkıt olabilir

Material:

- Aluminium extruded housing
- Plexiglass diffuser
- Built-in LED driver
- Electrostatic powder coated
- Suspended available



Renk:

- Beyaz
- Siyah
- Gri

Colour:

- White
- Black
- Gray



LED Tipi	Renk Sıcaklığı	Işık Akısı	Sistem Gücü	Voltaj	L			IP
SMD LED	3000 K / 4000 K	4250 lm	50 W	220V	63X63 cm	120°	1 pc	20

LED

60144

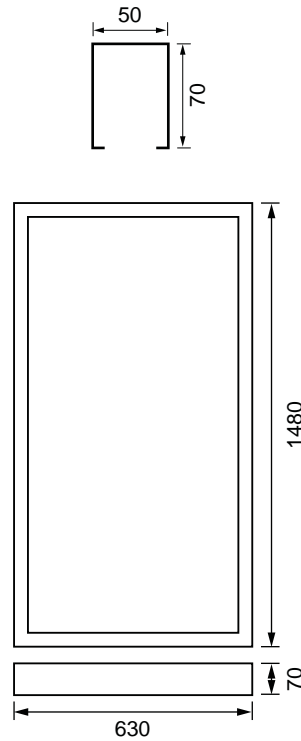
**Malzeme:**

- Alüminyum çekme gövde
- Pleksiglas difüzör
- Dahili LED sürücülü
- Elektrostatik toz boyama
- Sarkıt olabilir

Material:

- Aluminium extruded housing
- Plexiglass diffuser
- Built-in LED driver
- Electrostatic powder coated
- Suspended available

Renk:

- Beyaz
- Siyah
- Gri

Colour:

- White
- Black
- Gray



LED Tipi	Renk Sıcaklığı	Işık Akısı	Sistem Gücü	Voltaj	L			IP
SMD LED	3000 / 4000 K	7000 lm	90 W	220V	63x148 cm	120°	1 pc	20

Minimalist



Malzeme:

- Alüminyum çekme gövde
- Plexiglass difüzör
- Dahili elektronik balast
- Elektrostatik toz boyama
- Birbirine eklenebilir
- Sarkıt olabilir

Material:

- Aluminium extruded housing
- Plexiglass diffuser
- Built-in electronic ballast
- Electrostatic powder coated
- Linkable
- Suspended available



Renk:

- Gümüş gri
- Siyah
- Beyaz

Colour:

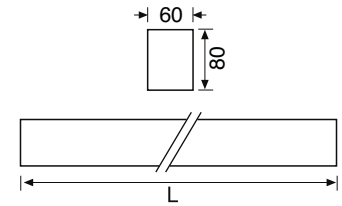
- Silver
- Black
- White



Kod				L	LM		IP 20
30114	G5	FH T 5	1x14 W	570	1200	1 pc	
30124	G5	FQ T 5	1x24W	570	1750	1 pc	
30214	G5	FH T 5	2x14 W	1140	2400	1 pc	
30224	G5	FQ T 5	2x24W	1140	3500	1 pc	
30121	G5	FH T 5	1x21W	870	1900	1 pc	
30221	G5	FH T 5	2x21W	1740	3800	1 pc	
30128	G5	FH T 5	1x28W	1170	2600	1 pc	
30228	G5	FH T 5	2x28W	2340	5200	1 pc	
30135	G5	FH T 5	1x35W	1470	3300	1 pc	
30235	G5	FH T 5	2x35W	2940	6600	1 pc	
30139	G5	FQ T 5	1x39W	870	3400	1 pc	
30239	G5	FQ T 5	2x39W	1740	6800	1 pc	
30149	G5	FQ T 5	1x49W	1470	4300	1 pc	
30249	G5	FQ T 5	2x49W	2940	8600	1 pc	
30154	G5	FQ T 5	1x54W	1170	4450	1 pc	
30254	G5	FQ T 5	2x54W	2340	8900	1 pc	
30180	G5	FQ T 5	1x80W	1470	6150	1 pc	
30280	G5	FQ T 5	2x80W	2940	12300	1 pc	
30136	G23	T 8	1x36W	1220	3350	1 pc	
30236	G23	T 8	2x36W	2440	6700	1 pc	
30158	G23	T 8	1x58W	1520	5200	1 pc	
30258	G23	T 8	2x58W	3050	10400	1 pc	

LED NEW

80100

80200

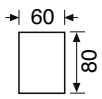
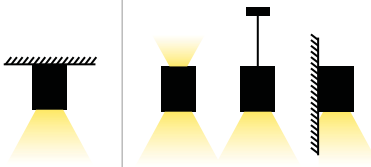
Standart
StandardOpsiyonel
Optional**Malzeme:**

- Alüminyum çekme gövde
- Pleksiglas difüzör
- Dahili LED sürücülü
- Elektrostatik toz boyama
- Sarkıt olabilir

Material:

- Aluminium extruded housing
- Plexiglass diffuser
- Built-in LED driver
- Electrostatic powder coated
- Suspended available

Renk:

- Gümüş gri
- Siyah & Altın
- Beyaz & Siyah
- Antrasit

Colour:

- Silver
- Black & Gold
- White & Black
- Anthracite

Designed by Güneş Jones

Kod	LED Tipi	Renk Sıcaklığı	Işık Akısı	Sistem Gücü	Voltaj	L	▲	☐	IP
80100	SMD LED	3000 K / 4000 K	2000 lm	24 W	220V	100 cm	120°	1 pc	20
80200	SMD LED	3000 K / 4000 K	4000 lm	48 W	220V	200 cm	120°	1 pc	

50100
50200
50300

LED

**Malzeme:**

- Alüminyum çekme gövde
- Pleksiglas difüzör
- Dahili LED sürücülü
- Elektrostatik toz boyama
- Birbirine eklenebilir
- Sarkıt olabilir

Material:

- Aluminium extruded housing
- Plexiglass diffuser
- Built-in LED driver
- Electrostatic powder coated
- Linkable
- Suspended available



Renk:

- Gümüş gri
- Siyah
- Beyaz
- Sarı

Colour:

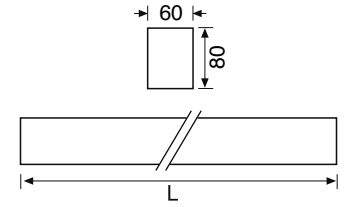
- Silver
- Black
- White
- Yellow



Kod	LED Tipi	Renk Sıcaklığı	Işık Akısı	Sistem Gücü	Voltaj	L			IP
50100	SMD LED	3000 / 4000 K	2000 lm	24 W	220V	100 cm	120°	1 pc	20
50200	SMD LED	3000 / 4000 K	4000 lm	48 W	220V	200 cm	120°	1 pc	
50300	SMD LED	3000 / 4000 K	6000 lm	72 W	220V	300 cm	120°	1 pc	

2036

**Renk:**

- Gümüş gri
- Siyah
- Beyaz

Colour:

- Silver
- Black
- White

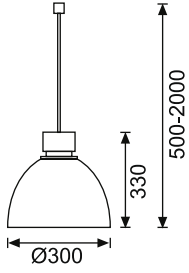

1 pc

**Malzeme:**

- Alüminyum çekme gövde
- Akrilik reflektör
- Elektrostatik toz boyama

Material:

- Aluminium extruded housing
- Acrylic reflector
- Electrostatic powder coated

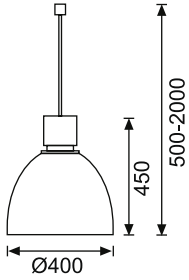
Renk:
• Gri**Colour:**
• Gray**Kod**SLK 2000a E 27
E 27Spiral
Spiral45 W
23 W1 pc
1 pcIP
20**Malzeme:**

- Alüminyum çekme gövde
- Akrilik reflektör
- Elektrostatik toz boyama

Material:

- Aluminium extruded housing
- Acrylic reflector
- Electrostatic powder coated

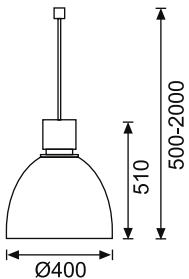
Renk:
• Gri**Colour:**
• Gray**Kod**SLK 2001a E 40
SLK 2001e E 27Spiral
Spiral80 W
23 W1 pc
1 pcIP
20**Malzeme:**

- Alüminyum çekme gövde
- Akrilik reflektör
- Elektrostatik toz boyama

Material:

- Aluminium extruded housing
- Acrylic reflector
- Electrostatic powder coated

Renk:
• Gri**Colour:**
• Gray**Kod**SLK 2000c G 12
SLK 2001g G 12HCI-T
HQI-BT70 W
150 W1 pc
1 pcIP
20



LG927

LG982

LED

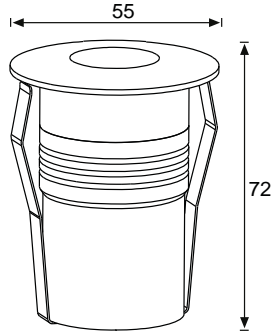
**Malzeme:**

- Alüminyum enjeksiyon gövde
- Paslanmaz çelik çerçeve 316 S.S.
- Isıya dayanıklı cam
- Dahili LED sürücülü
- Plastik kör kasalı

Material:

- Die-cast aluminium housing
- Stainless steel frame 316 S.S.
- Tempered glass
- Built-in LED driver
- With plastic sleeve

Renk:

- Kumlu
- Paslanmaz
- Çelik

Colour:

- Sanded
- Stainless
- Steel



LED Tipi	Renk Sıcaklığı	Işık Akısı	Sistem Gücü	Voltaj	Ø50 mm	38x29x27 cm / 24 pcs	Y	IP 67
SMD LED	3000 K / 6500 K	150 lm	3.5 W	230 V				

LED

HARVATEK inside

LG947

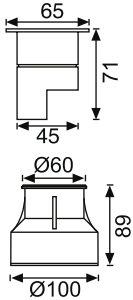
**Malzeme:**

- Alüminyum enjeksiyon gövde
- Paslanmaz çelik çerçeve 316 S.S.
- Güçlendirilmiş buzlu cam
- Max. statik yük: 2000 KG
- Max. araç geçiş hızı: 25 Km/Saat
- Dahili LED sürücülü
- Plastik kör kasalı

Material:

- Die-cast aluminium housing
- Stainless steel trim 316 S.S.
- Strengthened frosted glass
- Static weight allowed: 2000 KG
- Max. drive-over speed: 25Km/ Hour
- Built-in LED driver
- With plastic sleeve

Renk:

- Paslanmaz
- Çelik

Colour:

- Stainless
- Steel



LED Tipi	Renk Sıcaklığı	Işık Akısı	Sistem Gücü	Voltaj	Ø60 mm	120°	41x22x19 cm / 8 pcs	Y	IP 67
Harvatek Power LED	3000 K / Mavi	50 lm	1 W	230 V					

LED

OSRAM inside

LG927

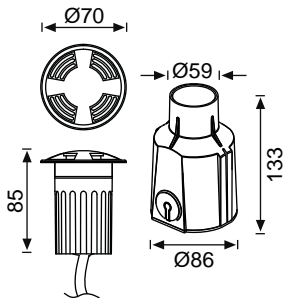
**Malzeme:**

- Alüminyum enjeksiyon gövde
- Paslanmaz çelik çerçeve 316 S.S.
- Dahili LED sürücülü
- Plastik kör kasalı

Material:

- Die-cast aluminium housing
- Stainless steel frame 316 S.S.
- Built-in LED driver
- With plastic sleeve

Renk:

- Paslanmaz
- Çelik

Colour:

- Stainless
- Steel



LED Tipi	Renk Sıcaklığı	Işık Akısı	Sistem Gücü	Voltaj	Ø70 mm	30°	37x26x31 cm / 18 pcs	Y	IP 67
OSRAM LED	3000 K	100 lm	2 W	230 V					

LG980



- Malzeme:**
- Deck armatürü
 - Paslanmaz çelik gövde
 - Dahili LED sürücülü

- Material:**
- Deck light
 - Stainless steel housing
 - Built-in LED driver

- Renk:**
- Paslanmaz Çelik
- Colour:**
- Stainless Steel

EPISTAR inside

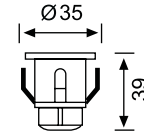

LED Tipi	Renk Sıcaklığı	Işık Akısı	Sistem Gücü	Voltaj				Y	IP
Epistar SMD LED	3000 K	50 lm	1 W	230 V	Ø30 mm	120°	35x15x37 cm / 50 pcs		65

LG977



- Malzeme:**
- Deck armatürü
 - Paslanmaz çelik gövde
 - Buzlu polikarbonat difüzör
 - Dahili LED sürücülü
 - Plastik kör kasalı

- Material:**
- Deck light
 - Stainless steel housing
 - Frosted polycarbonate diffuser
 - Built-in LED driver
 - With plastic sleeve

- Renk:**
- Paslanmaz Çelik
- Colour:**
- Stainless Steel

EPISTAR inside

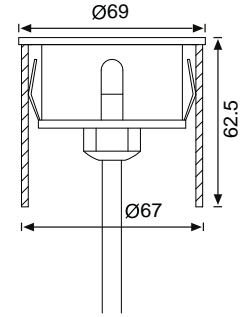

LED Tipi	Renk Sıcaklığı	Işık Akısı	Sistem Gücü	Voltaj				Y	IP
Epistar SMD LED	3000 K	50 lm	1 W	230 V	Ø67 mm		42x25x35 cm / 60 pcs		65

LG988



- Malzeme:**
- Alüminyum enjeksiyon gövde
 - Paslanmaz çelik çerçeve 316 S.S.
 - Dahili LED sürücülü
 - Plastik kör kasalı

- Material:**
- Die-cast aluminium housing
 - Stainless steel frame 316 S.S.
 - Built-in LED driver
 - With plastic sleeve

- Renk:**
- Paslanmaz Çelik
- Colour:**
- Stainless Steel

EPISTAR inside

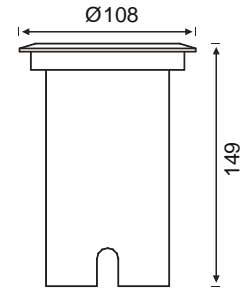

LED Tipi	Renk Sıcaklığı	Işık Akısı	Sistem Gücü	Voltaj				Y	IP
Epistar SMD LED	3000 K	500 lm	7 W	230 V	Ø108 mm	60°	37x25x34 cm / 12 pcs		65

LG978



- Malzeme:**
- Alüminyum enjeksiyon gövde
 - Paslanmaz çelik çerçeve 316 S.S.
 - Dahili LED sürücülü
 - Plastik kör kasalı

- Material:**
- Die-cast aluminium housing
 - Stainless steel frame 316 S.S.
 - Built-in LED driver
 - With plastic sleeve

- Renk:**
- Paslanmaz Çelik
- Colour:**
- Stainless Steel

bridgelux. inside

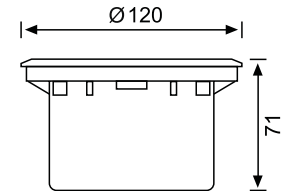

LED Tipi	Renk Sıcaklığı	Işık Akısı	Sistem Gücü	Voltaj			Y	IP
Bridgelux Power LED	3000 K	350 lm	7 W	230 V	30°	27x27x27 cm / 12 pc		65

LG925

LED OSRAM inside

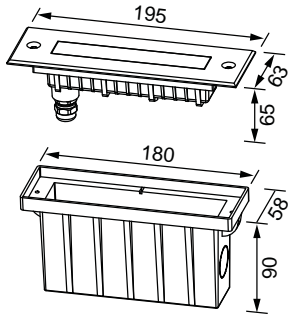
**Malzeme:**

- Alüminyum gövde
- Paslanmaz çelik çerçeve 316 S.S.
- Dahili LED sürücülü
- Plastik kör kasalı

Material:

- Aluminium housing
- Stainless steel frame 316 S.S.
- Built-in LED driver
- With plastic sleeve

Renk:

- Paslanmaz Çelik

Colour:

- Stainless Steel



LED Tipi	Renk Sıcaklığı	Işık Akısı	Sistem Gücü	Voltaj				Y	IP
OSRAM LED	3000 K	340 lm	3x2 W	230 V	180x58x90 mm	25°	45x25x23 cm / 12 pcs		67

LG926

LED OSRAM inside

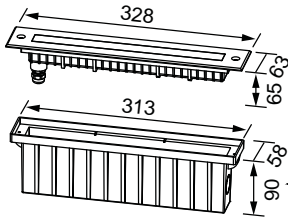
**Malzeme:**

- Alüminyum gövde
- Paslanmaz çelik çerçeve 316 S.S.
- Dahili LED sürücülü
- Plastik kör kasalı

Material:

- Aluminium housing
- Stainless steel frame 316 S.S.
- Built-in LED driver
- With plastic sleeve

Renk:

- Paslanmaz Çelik

Colour:

- Stainless Steel



LED Tipi	Renk Sıcaklığı	Işık Akısı	Sistem Gücü	Voltaj				Y	IP
OSRAM LED	3000 K	740 lm	6x2 W	230 V	313x58x90 mm	25°	37x24x23 cm / 6 pcs		67

LG979

LED CITIZEN inside

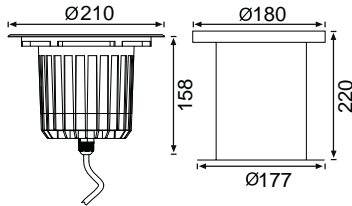
**Malzeme:**

- Alüminyum enjeksiyon gövde
- Paslanmaz çelik çerçeve 316 S.S.
- Isıya dayanıklı cam
- Dahili LED sürücülü
- Metal kör kasalı

Material:

- Die-cast aluminium housing
- Stainless steel frame 316 S.S.
- Tempered glass
- Built-in LED driver
- With metal sleeve

Renk:

- Paslanmaz Çelik

Colour:

- Stainless Steel



LED Tipi	Renk Sıcaklığı	Işık Akısı	Sistem Gücü	Voltaj				Y	IP
Citizen COB LED	3000 K	1000 lm	20 W	230 V	Ø175 mm	24°	49x25x51 cm / 4 pcs		67

LG983

LED bridgelux inside

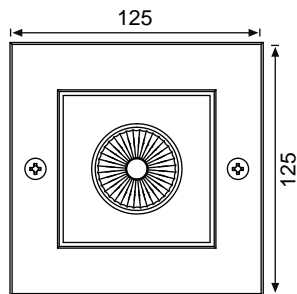
**Malzeme:**

- Alüminyum enjeksiyon gövde
- Paslanmaz çelik çerçeve 316 S.S.
- Isıya dayanıklı cam
- Dahili LED sürücülü
- Metal kör kasalı

Material:

- Die-cast aluminium housing
- Stainless steel frame 316 S.S.
- Tempered glass
- Built-in LED driver
- With steel sleeve

Renk:

- Paslanmaz Çelik

Colour:

- Stainless Steel



LED Tipi	Renk Sıcaklığı	Işık Akısı	Sistem Gücü	Voltaj				Y	IP
Bridgelux COB LED	3000 K	400 lm	8 W	230 V	Ø115 mm	25°	31x30x26 cm / 8 pcs		67

JG659



Malzeme:

- Alüminyum enjeksiyon gövde
- Paslanmaz çelik çerçeve 304 S.S.
- Isıya dayanıklı cam
- Plastik kör kasalı

Material:

- Die-cast aluminium housing
- Stainless steel frame 304 S.S.
- Tempered clear glass
- With plastic sleeve

Renk:

- Paslanmaz Çelik

Colour:

- Stainless Steel

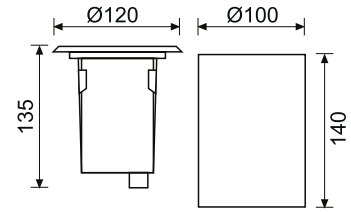

GU 10



LED Par 16

5 W



Ø100 mm



37x25x38 cm / 12 pcs



65

JG676



Malzeme:

- Alüminyum enjeksiyon gövde
- Paslanmaz çelik çerçeve 316 S.S.
- Isıya dayanıklı cam
- Plastik kör kasalı

Material:

- Die-cast aluminium housing
- Stainless steel frame 316 S.S.
- Tempered clear glass
- With plastic sleeve

Renk:

- Paslanmaz Çelik

Colour:

- Stainless Steel

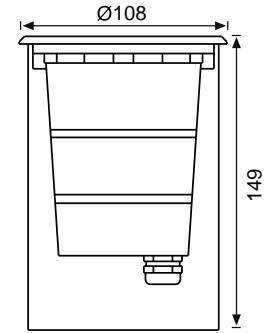

GU 10



LED Par 16

5 W



Ø100 mm



37x25x34 cm / 12 pcs



65

JG677



Malzeme:

- Alüminyum enjeksiyon gövde
- Paslanmaz çelik çerçeve 304 S.S.
- Isıya dayanıklı cam
- Plastik kör kasalı

Material:

- Die-cast aluminium housing
- Stainless steel frame 304 S.S.
- Tempered clear glass
- With plastic sleeve

Renk:

- Paslanmaz Çelik

Colour:

- Stainless Steel

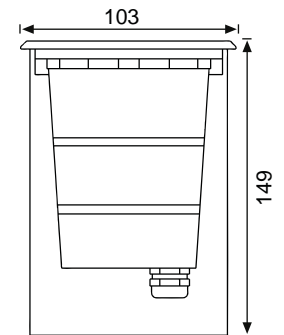

GU 10



LED Par 16 / JA211

5 W / 11 W



Ø98 mm



37x25x34 cm / 12 pcs



65

JG673

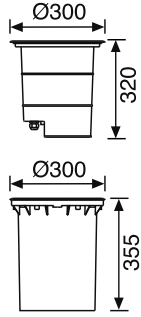
**Malzeme:**

- Alüminyum enjeksiyon gövde
- Paslanmaz çelik çerçeve 316 S.S.
- 15° alüminyum reflektör
- Isıya dayanıklı, güçlendirilmiş cam
- Max. statik yük: 2000 KG
- Max. araç geçiş hızı: 25 Km/Saat
- Polyester toz boya
- Plastik kör kasalı

Material:

- Die-cast aluminium housing
- Stainless steel frame 316 S.S.
- 15° aluminium reflector
- Tempered and strengthened glass
- Static weight allowed: 2000 KG
- Max. drive-over speed: 25Km/ Hour
- Polyester powder coated
- With plastic sleeve

Renk:

- Paslanmaz Çelik

Colour:

- Stainless Steel



G 12



HCI-T

150 W



Ø290 mm



31.5x34.5x38 cm / 1 pc

Y

IP

67

JG675

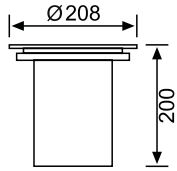
**Malzeme:**

- Alüminyum enjeksiyon gövde
- Paslanmaz çelik çerçeve 304 SS
- Alüminyum reflektör
- Isıya dayanıklı benekli cam
- Elektrostatik toz boyama
- Plastik kör kasalı

Material:

- Die-cast aluminium housing
- Stainless steel frame 304 SS
- Aluminium reflector
- Tempered glass with dots
- Electrostatic powder coated
- With plastic sleeve

Renk:

- Paslanmaz Çelik

Colour:

- Stainless Steel



E 27



Spiral

20 W



Ø200 mm



42x42x28 cm / 4 pcs

Y

IP

65

JG671

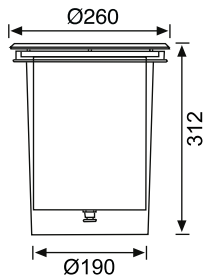
**Malzeme:**

- Alüminyum enjeksiyon gövde
- Paslanmaz çelik çerçeve 304 S.S.
- Isıya dayanıklı güçlendirilmiş cam
- Max. statik yük: 2000 KG
- Max. araç geçiş hızı: 25 Km/Saat
- Polyester toz boya
- Plastik kör kasalı

Material:

- Die-cast aluminium housing
- Stainless steel frame 304 S.S.
- Tempered and strengthened glass
- Static weight allowed: 2000 KG
- Max. drive-over speed: 25Km/ Hour
- Polyester powder coated
- With plastic sleeve

Renk:

- Paslanmaz Çelik

Colour:

- Stainless Steel



Rx 7s



HQI-TS

150 W



Ø190 mm



52x52x33 cm / 4 pcs

Y

IP

65



LW470





LW427

LW452

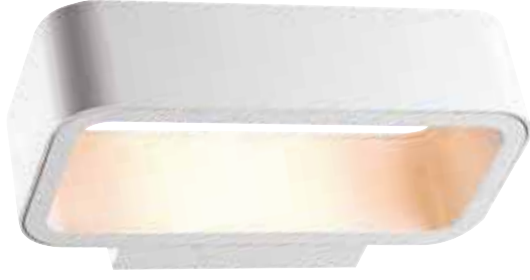

Malzeme:

- Alüminyum enjeksiyon gövde
- Polikarbonat buzlu difüzör
- Elektrostatik toz boyama
- Dahili LED sürücülü

Material:

- Die-cast aluminium housing
- Polycarbonate frosted diffuser
- Electrostatic powder coated
- Built-in LED driver

Renk:
• Beyaz

Colour:
• White

bridgelux® inside

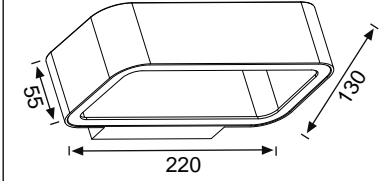

LED Tipi	Renk Sıcaklığı	Işık Akısı	Sistem Gücü	Voltaj				IP
Bridgelux LED	3000 K	350 lm	7.5 W	230V		43x25x26 cm / 12 pcs	Y	54

LW466



Malzeme:

- Alüminyum enjeksiyon gövde
- Isıya dayanıklı cam
- Elektrostatik toz boyama
- Dahili LED sürücülü

Material:

- Die-cast aluminium housing
- Tempered glass
- Electrostatic powder coated
- Built-in LED driver

Renk:
• Beyaz

Colour:
• White

CREE® inside

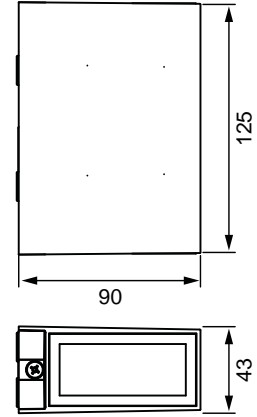

LED Tipi	Renk Sıcaklığı	Işık Akısı	Sistem Gücü	Voltaj				IP
Cree COB LED	3000 K	210 lm	2x3 W	230 V	60°	30x18.5x30 cm / 18 pcs	Y	54

LW465



Malzeme:

- Alüminyum enjeksiyon gövde
- Isıya dayanıklı cam
- Elektrostatik toz boyama
- Dahili LED sürücülü

Material:

- Die-cast aluminium housing
- Tempered glass
- Electrostatic powder coated
- Built-in LED driver

Renk:
• Antrasit

Colour:
• Anthracite

CREE® inside

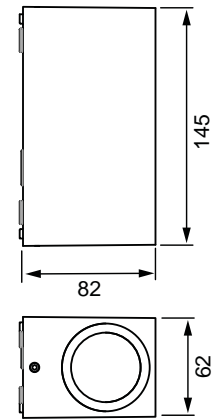

LED Tipi	Renk Sıcaklığı	Işık Akısı	Sistem Gücü	Voltaj				IP
Cree COB LED	3000 K	930 lm	2x7 W	230 V	60°	33.5x19.5x23 cm / 12 pcs	Y	54

LED

CREE inside

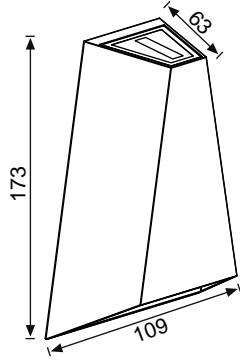
**Malzeme:**

- Alüminyum enjeksiyon gövde
- Isıya dayanıklı cam
- Elektrostatik toz boyama
- Dahili LED sürücüsü

Material:

- Die-cast aluminium housing
- Tempered glass
- Electrostatic powder coated
- Built-in LED driver

Renk:

- Antrasit

Colour:

- Anthracite

LW427



LED Tipi	Renk Sıcaklığı	Işık Akısı	Sistem Gücü	Voltaj
Cree Power LED	3000 K	300 lm	2x3 W	230V

37.5x23x26 cm / 12 pcs

Y

IP
54

LED

CREE inside

NEW

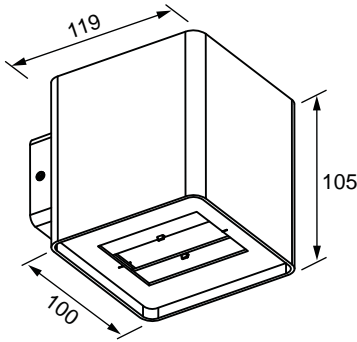
**Malzeme:**

- Alüminyum enjeksiyon gövde
- Dahili 300 mA HEP sürücüsü
- Şeffaf cam
- Elektrostatik toz boyama
- 30°-130° ayarlanabilir ışık açısı

Material:

- Die-cast aluminium housing
- Built-in 300 mA HEP driver
- Clear glass
- Electrostatic powder coated
- 30°-130° adjustable beam angle

Renk:

- Antrasit

Colour:

- Anthracite

LW470



LED Tipi	Renk Sıcaklığı	Işık Akısı	Sistem Gücü	Voltaj
Cree COB LED	3000 K	880 lm	14 W	230 V

32x25x27 cm / 8 pcs

Y

IP
54

LED

CREE inside

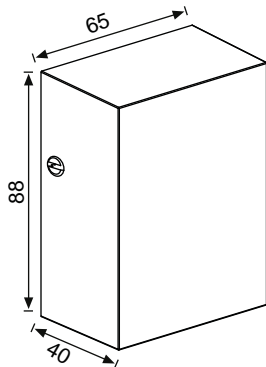
**Malzeme:**

- Alüminyum enjeksiyon gövde
- Isıya dayanıklı cam
- Elektrostatik toz boyama
- Dahili LED sürücüsü

Material:

- Die-cast aluminium housing
- Tempered glass
- Electrostatic powder coated
- Built-in LED driver

Renk:

- Antrasit

Colour:

- Anthracite

LW428



LED Tipi	Renk Sıcaklığı	Işık Akısı	Sistem Gücü	Voltaj
Cree Power LED	3000 K	150 lm	4 W	230V

30x17x23 cm / 24 pcs

Y

IP
54

LW464



Malzeme:

- Alüminyum gövde
- Isıya dayanıklı cam
- Alüminyum reflector
- Dahili LED sürücülü

Material:

- Aluminium housing
- Tempered glass
- Aluminium reflector
- Built-in LED driver

Renk:

- Antrasit

Colour:

- Anthracite

SHARP inside

LED

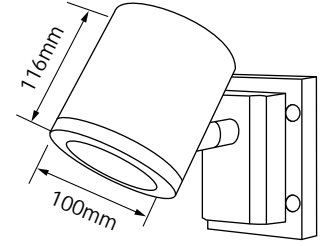

LED Tipi	Renk Sıcaklığı	Işık Akısı	Sistem Gücü	Voltađ	35°	56x42.5x25.5 cm / 12 pcs	Y	IP 54
Sharp COB LED	3000 K	735 lm	11 W	230 V				

LC436



Malzeme:

- Alüminyum gövde
- Alüminyum reflektör
- Isıya dayanıklı cam
- Elektrostatik toz boyama
- Dahili LED sürücülü

Material:

- Aluminium housing
- Aluminium reflector
- Tempered glass
- Electrostatic powder coated
- Built-in LED driver

Renk:

- Antrasit

Colour:

- Anthracite

SHARP inside

LED

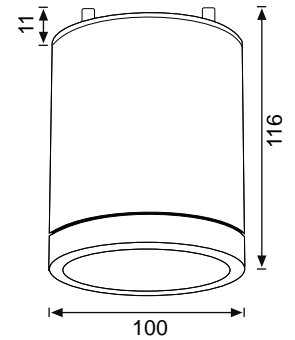

LED Tipi	Renk Sıcaklığı	Işık Akısı	Sistem Gücü	Voltađ	35°	50x46x19 cm / 12 pcs	Y	IP 54
Sharp COB LED	3000 K	735 lm	11 W	230 V				

LED

SHARP inside

LW433

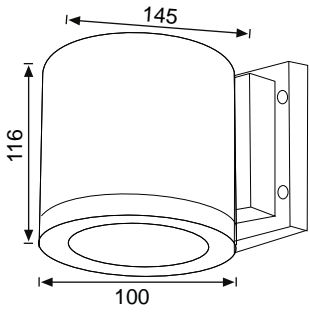
**Malzeme:**

- Alüminyum gövde
- Alüminyum reflektör
- Isıya dayanıklı cam
- Elektrostatik toz boyama
- Dahili LED sürücülü

Material:

- Aluminium housing
- Aluminium reflector
- Tempered glass
- Electrostatic powder coated
- Built-in LED driver

Renk:

- Antrasit

Colour:

- Anthracite



LED Tipi	Renk Sıcaklığı	Işık Akısı	Sistem Gücü	Voltaj
Sharp COB LED	3000 K	735 lm	11 W	230V



35°



44.8x38.2x29.7 cm / 12 pcs

Y

IP
54

LED

SHARP inside

LW434

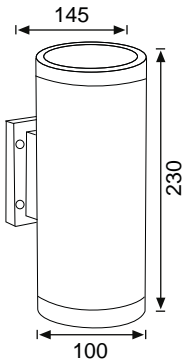
**Malzeme:**

- Alüminyum gövde
- Alüminyum reflektör
- Isıya dayanıklı cam
- Elektrostatik toz boyama
- Dahili LED sürücülü

Material:

- Aluminium housing
- Aluminium reflector
- Tempered glass
- Electrostatic powder coated
- Built-in LED driver

Renk:

- Antrasit

Colour:

- Anthracite



LED Tipi	Renk Sıcaklığı	Işık Akısı	Sistem Gücü	Voltaj
Sharp COB LED	3000 K	1514 lm	2x11 W	230V



35°



62.5x33x39.5 cm / 8 pcs

Y

IP
54

JW936



Malzeme:

- Alüminyum enjeksiyon gövde
- Isıya dayanıklı cam
- Elektrostatik toz boyama

Material:

- Die-cast aluminium housing
- Tempered glass
- Electrostatic powder coated

Renk:

- Antrasit

Colour:

- Anthracite

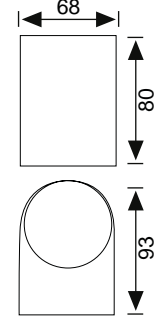

GU 10



LED Par 16

5 W



29.5x26.5x23 cm / 18 pcs

Y

IP

44

JW937



Malzeme:

- Alüminyum enjeksiyon gövde
- Isıya dayanıklı cam
- Elektrostatik toz boyama

Material:

- Die-cast aluminium housing
- Tempered glass
- Electrostatic powder coated

Renk:

- Antrasit

Colour:

- Anthracite

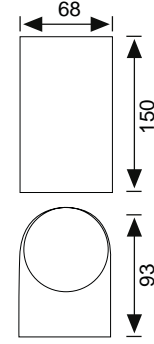

GU 10



LED Par 16

2x5 W



32.5x26.5x35 cm / 18 pcs

Y

IP

44

JW527



Malzeme:

- Alüminyum enjeksiyon gövde
- Isıya dayanıklı cam
- Elektrostatik toz boyama
- Sensörlü

Material:

- Die-cast aluminium housing
- Tempered glass
- Electrostatic powder coated
- With sensor

Renk:

- Antrasit

Colour:

- Anthracite

SENSOR

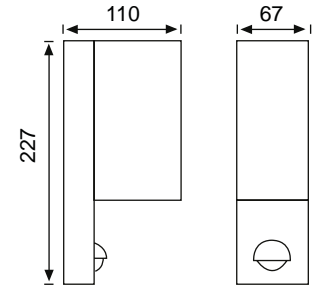

GU 10



LED Par 16

2x5 W



38x29x30 cm / 12 pcs

Y

IP

44

JW928

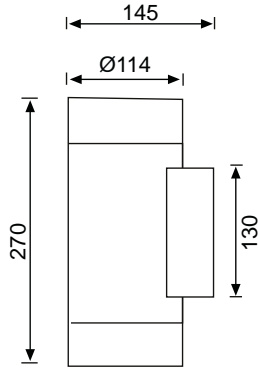
**Malzeme:**

- Paslanmaz çelik gövde
- Isıya dayanıklı cam

Material:

- Stainless steel housing
- Tempered clear glass

Renk:

- Paslanmaz Çelik

Colour:

- Stainless Steel



E 27



Halopar 30/LED Par 30

2x75 W



58x31x48.5 cm / 12 pcs

Y

IP

44

JW946

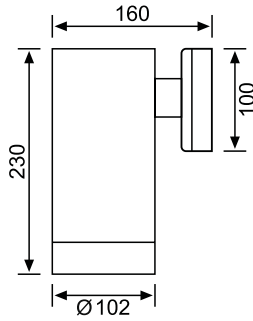
**Malzeme:**

- Paslanmaz çelik gövde
- Isıya dayanıklı cam

Material:

- Stainless steel housing
- Tempered clear glass

Renk:

- Paslanmaz Çelik

Colour:

- Stainless Steel



E 27



Spiral

23 W



35x35x26.5 cm / 6 pcs

Y

IP

44

JW947

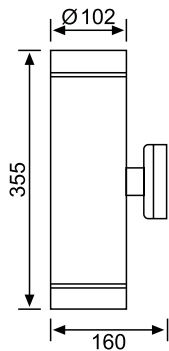
**Malzeme:**

- Paslanmaz çelik gövde
- Isıya dayanıklı cam

Material:

- Stainless steel housing
- Tempered clear glass

Renk:

- Paslanmaz Çelik

Colour:

- Stainless Steel



E 27



Spiral

2x23 W



35x35x39 cm / 6 pcs

Y

IP

44

JW961



- Malzeme:**
- Alüminyum gövde
 - Şeffaf cam
 - Elektrostatik toz boyama
- Material:**
- Aluminium housing
 - Clear glass
 - Electrostatic powder coated

- Renk:**
- Gümüş Gri
- Colour:**
- Silver Gray

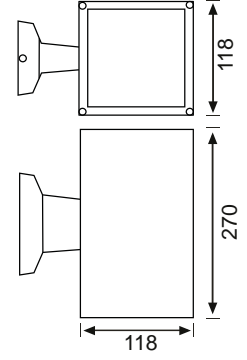

E 27

Halopar 30/LED Par 30

2x75 W



63x30x41 cm / 10 pcs

Y

IP

54

JW960



- Malzeme:**
- Alüminyum gövde
 - Şeffaf cam
 - Elektrostatik toz boyama
- Material:**
- Aluminium housing
 - Clear glass
 - Electrostatic powder coated

- Renk:**
- Gümüş Gri
- Colour:**
- Silver Gray

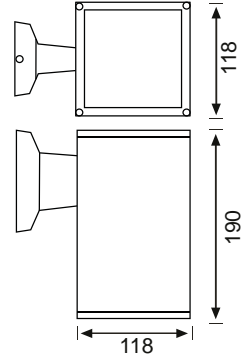

E 27

Halopar 30/LED Par 30

75 W



63x22x41 cm / 10 pcs

Y

IP

54

JW964



- Malzeme:**
- Alüminyum gövde
 - Şeffaf cam
 - Elektrostatik toz boyama
- Material:**
- Aluminium housing
 - Clear glass
 - Electrostatic powder coated

- Renk:**
- Gümüş Gri
- Colour:**
- Silver Gray

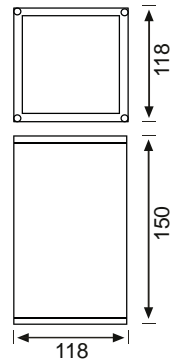

E 27

Halopar 30/LED Par 30

75 W



38x50x33 cm / 12 pcs

Y

IP

54

JW926

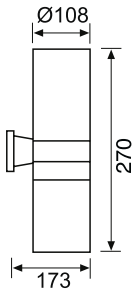
**Malzeme:**

- Alüminyum gövde
- Isıya dayanıklı cam
- Elektrostatik toz boyama

Material:

- Aluminium housing
- Tempered glass
- Electrostatic powder coated

Renk:

- Gümüş Gri

Colour:

- Silver Gray

E 27



Halopar 30/LED Par 30

2x75 W



57x35x37 cm / 12 pcs

Y

IP

44

JW927

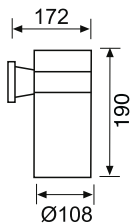
**Malzeme:**

- Alüminyum gövde
- Isıya dayanıklı cam
- Elektrostatik toz boyama

Material:

- Aluminium housing
- Tempered glass
- Electrostatic powder coated

Renk:

- Gümüş Gri

Colour:

- Silver Gray

E 27



Halopar 30/LED Par 30

75 W



57x41x38 cm / 20 pcs

Y

IP

44

JW918



- Malzeme:**
- Paslanmaz çelik gövde
 - Isıya dayanıklı cam

- Material:**
- Stainless steel housing
 - Tempered glass

- Renk:**
- Paslanmaz Çelik

- Colour:**
- Stainless Steel

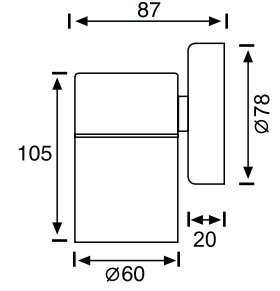

GU 10



LED Par 16

5 W



30x18x26 cm / 12 pcs

Y

IP

44

JW919



- Malzeme:**
- Paslanmaz çelik gövde
 - Isıya dayanıklı cam

- Material:**
- Stainless steel housing
 - Tempered glass

- Renk:**
- Paslanmaz Çelik

- Colour:**
- Stainless Steel

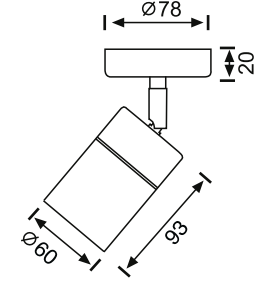

GU 10



LED Par 16

5 W



33.5x18x26 cm / 12 pcs

Y

IP

44

JW917



- Malzeme:**
- Paslanmaz çelik gövde
 - Isıya dayanıklı cam

- Material:**
- Stainless steel housing
 - Tempered glass

- Renk:**
- Paslanmaz Çelik

- Colour:**
- Stainless Steel

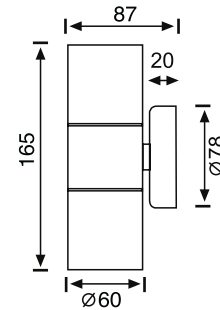

GU 10



LED Par 16

2x5 W



39.5x19x28 cm / 12 pcs

Y

IP

44

JW958

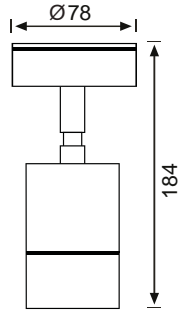
**Malzeme:**

- Alüminyum gövde
- Şeffaf cam
- Elektrostatik toz boyama

Material:

- Aluminium housing
- Clear glass
- Electrostatic powder coated

Renk:

- Gümüş Gri

Colour:

- Silver Gray



GU 10



LED Par 16 / JA211

5 W / 11 W



44.5x19x25 cm / 10 pcs

Y

IP

54

JW959

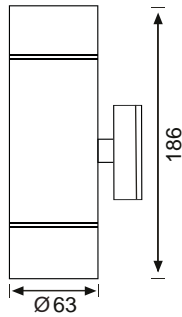
**Malzeme:**

- Alüminyum gövde
- Şeffaf cam
- Elektrostatik toz boyama

Material:

- Aluminium housing
- Clear glass
- Electrostatic powder coated

Renk:

- Gümüş Gri

Colour:

- Silver Gray



GU 10



LED Par 16 / JA211

2x5 W / 2x11 W



44.5x20.5x25 cm / 10 pcs

Y

IP

54

JW941

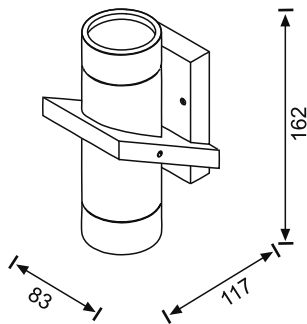
**Malzeme:**

- Alüminyum gövde
- Isiya dayanıklı cam

Material:

- Aluminium housing
- Tempered glass

Renk:

- Alüminyum

Colour:

- Aluminium



GU 10



LED Par 16

2x5 W



38x29x30 cm / 12 pcs

Y

IP

54

JW907



Malzeme:

- Paslanmaz çelik gövde
- Polikarbonat difüzör

Material:

- Stainless steel housing
- Polycarbonate diffuser

Renk:

- Paslanmaz Çelik

Colour:

- Stainless Steel

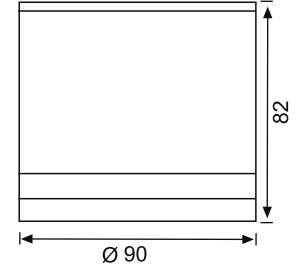

GX53



LA011

5 W



20x20x30 cm / 12 pcs



44

JW904



Malzeme:

- Paslanmaz çelik gövde
- Polikarbonat difüzör

Material:

- Stainless steel housing
- Polycarbonate diffuser

Renk:

- Paslanmaz Çelik

Colour:

- Stainless Steel

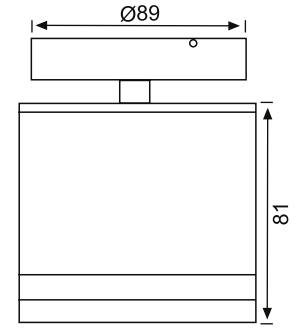

GX53



LA011

5 W



32x32x37 cm / 12 pcs



44

JW905



Malzeme:

- Paslanmaz çelik gövde
- Polikarbonat difüzör

Material:

- Stainless steel housing
- Polycarbonate diffuser

Renk:

- Paslanmaz Çelik

Colour:

- Stainless Steel

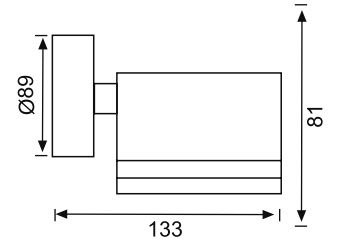

GX53



LA011

5 W



35x21x30 cm / 12 pcs



44

JW906



Malzeme:

- Paslanmaz çelik gövde
- Polikarbonat difüzör

Material:

- Stainless steel housing
- Polycarbonate diffuser

Renk:

- Paslanmaz Çelik

Colour:

- Stainless Steel

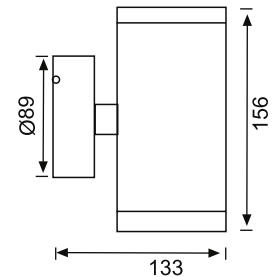

GX53



LA011

2 x 5 W



45x21x37 cm / 12 pcs



44

JW963

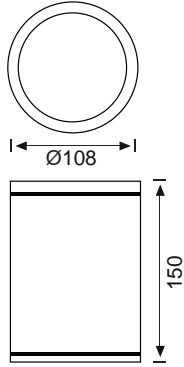
**Malzeme:**

- Alüminyum gövde
- Şeffaf cam
- Elektrostatik toz boyama

Material:

- Aluminium housing
- Clear glass
- Electrostatic powder coated

Renk:

- Gümüş Gri

Colour:

- Silver Gray



E 27



Halopar 30/LED Par 30

75 W



47x36x20.5 cm / 12 pcs

Y

IP

54

JC063

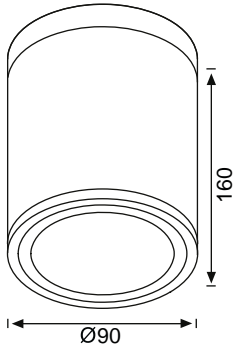
**Malzeme:**

- Alüminyum gövde
- Isıya dayanıklı cam
- Elektrostatik toz boyama

Material:

- Aluminium housing
- Tempered glass
- Electrostatic powder coated

Renk:

- Antrasit

Colour:

- Anthracite



GU 10



LED Par 16

5 W



49.5x21x26 cm / 20 pcs

Y

IP

54

JC064

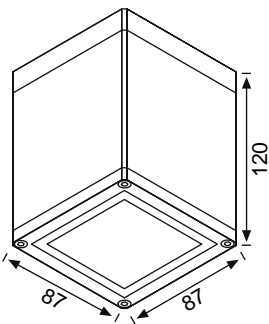
**Malzeme:**

- Alüminyum gövde
- Isıya dayanıklı cam
- Elektrostatik toz boyama

Material:

- Aluminium housing
- Tempered glass
- Electrostatic powder coated

Renk:

- Kumlu Beyaz

Colour:

- Sandy White



GU 10



LED Par 16

5 W



49.5x21x26 cm / 20 pcs

Y

IP

54

JW682



Malzeme:

- Alüminyum enjeksiyon gövde
- Buzlu cam difüzör
- Elektrostatik toz boyama

Material:

- Die-cast aluminium housing
- Frosted glass diffuser
- Electrostatic powder coated

Renk:

- Gümüş Gri

Colour:

- Silver Gray

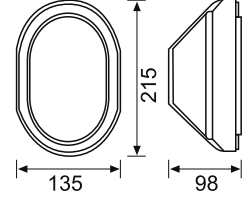

E 27



Spiral

15 W



46.5x45x25.5 cm / 12 pcs

Y

IP

54

JW684



Malzeme:

- Alüminyum enjeksiyon gövde
- Buzlu cam difüzör
- Elektrostatik toz boyama

Material:

- Die-cast aluminium housing
- Frosted glass diffuser
- Electrostatic powder coated

Renk:

- Gümüş Gri

Colour:

- Silver Gray

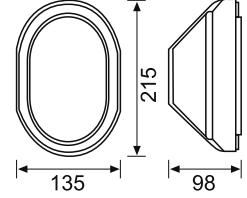

E 27



Spiral

15 W



46.5x45x25.5 cm / 12 pcs

Y

IP

54

JW690



Malzeme:

- Alüminyum enjeksiyon gövde
- Buzlu cam difüzör
- Elektrostatik toz boyama

Material:

- Die-cast aluminium housing
- Frosted glass diffuser
- Electrostatic powder coated

Renk:

- Gümüş Gri

Colour:

- Silver Gray

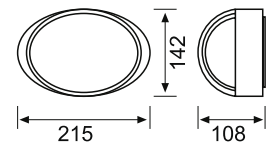

E 27



Spiral

15 W



67x31x35 cm / 18 pcs

Y

IP

54

JG826

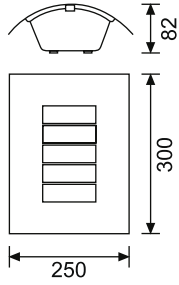
**Malzeme:**

- Paslanmaz çelik gövde 304 S.S.
- Opal polikarbonat difüzör

Renk:

- Paslanmaz Çelik

Material:

- Stainless steel housing 304 S.S.
- Opal polycarbonate diffuser

Colour:

- Stainless Steel



E 27



Spiral

20 W



72.5x32x42 cm / 12 pcs

Y

IP

44

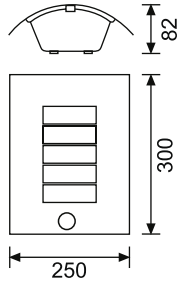

JG828

**Malzeme:**

- Paslanmaz çelik gövde 304 S.S.
- Opal polikarbonat difüzör
- Sensörlü

Renk:

- Paslanmaz Çelik

Material:

- Stainless steel housing 304 S.S.
- Opal polycarbonate diffuser
- With sensor

Colour:

- Stainless Steel



E 27



Halogen Eco Classic A

30 W



72.5x32x42 cm / 12 pcs

Y

IP

44

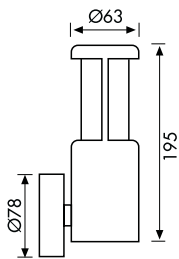
**Malzeme:**

- Alüminyum enjeksiyon gövde
- Opal polikarbonat difüzör
- Elektrostatik toz boyama

Renk:

- Beyaz
- Gümüş Gri

Material:

- Die-cast aluminium housing
- Opal polycarbonate diffuser
- Electrostatic powder coated

Colour:

- White
- Silver Gray



JW901



G 9



Halopin

25 W



28x23x44 cm / 12 pcs

Y

IP

54

JW974



- Malzeme:**
- Alüminyum enjeksiyon gövde
 - Opal polikarbonat difüzör
 - Polyester toz boyama

- Material:**
- Die-cast aluminium housing
 - Opal polycarbonate diffuser
 - Polyester powder coated

- Renk:**
- Antrasit
- Colour:**
- Anthracite

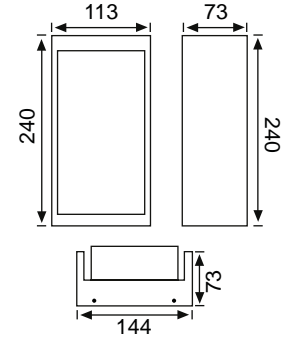

E 27



Spiral

18 W



42x32x27 cm / 10 pcs

Y

IP

54

JW526



- Malzeme:**
- Alüminyum enjeksiyon gövde
 - Opal polikarbonat difüzör
 - Polyester toz boyama
 - Sensörlü

- Material:**
- Die-cast aluminium housing
 - Opal polycarbonate diffuser
 - Polyester powder coated
 - With sensor

- Renk:**
- Antrasit
- Colour:**
- Anthracite

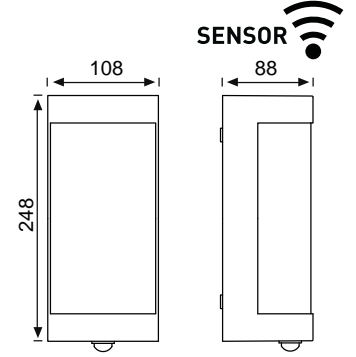

E 27



Halogen Eco Classic A

30 W



52x25x28 cm / 30 pcs

Y

IP

54

JW929



- Malzeme:**
- Alüminyum enjeksiyon gövde
 - Opal polikarbonat difüzör
 - Polyester toz boyama

- Material:**
- Die-cast aluminium housing
 - Opal polycarbonate diffuser
 - Polyester powder coated

- Renk:**
- Antrasit
- Colour:**
- Anthracite

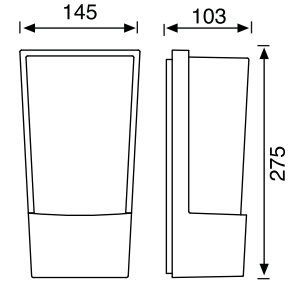

E 27

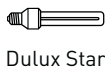

Dulux Star

20 W



46x29.5x47 cm / 12 pcs

Y

IP

44

JW930



- Malzeme:**
- Alüminyum enjeksiyon gövde
 - Opal polikarbonat difüzör
 - Polyester toz boyama
 - Sensörlü

- Material:**
- Die-cast aluminium housing
 - Opal polycarbonate diffuser
 - Polyester powder coated
 - With sensor

- Renk:**
- Antrasit
- Colour:**
- Anthracite

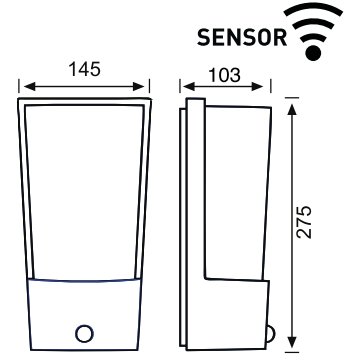

E 27



Halogen Eco Classic A

30 W



46x29.5x47 cm / 12 pcs

Y

IP

44

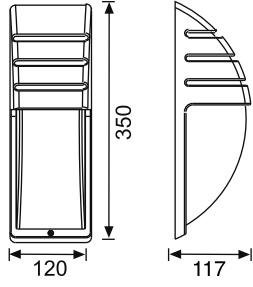
**Malzeme:**

- Alüminyum enjeksiyon gövde
- Opal polikarbonat difüzör
- Polyester toz boyama

Material:

- Die-cast aluminium housing
- Opal polycarbonate diffuser
- Polyester powder coated

Renk:

- Siyah

Colour:

- Black



JW935



E 27



Spiral

23 W



39x27x38 cm / 10 pcs

Y

IP

44

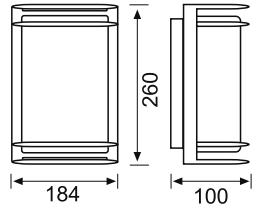
**Malzeme:**

- Alüminyum enjeksiyon gövde
- Opal polikarbonat difüzör
- Polyester toz boyama

Material:

- Die-cast aluminium housing
- Opal polycarbonate diffuser
- Polyester powder coated

Renk:

- Antrasit

Colour:

- Anthracite



JW931



E 27



Spiral

23 W



57x28x39 cm / 10 pcs

Y

IP

54

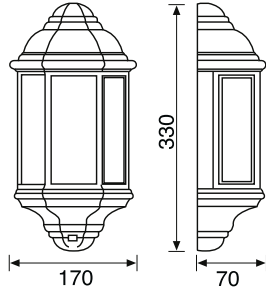
**Malzeme:**

- Alüminyum enjeksiyon gövde
- Buzlu cam
- Elektrostatik toz boyama

Material:

- Die-cast aluminium housing
- Frosted glass
- Electrostatic powder coated

Renk:

- Siyah

Colour:

- Black



JW932



E 27



Spiral

20 W



39x36x35 cm / 8 pcs

Y

IP

33

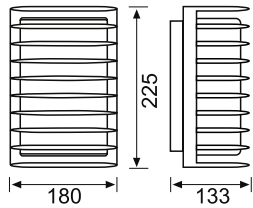
**Malzeme:**

- Alüminyum enjeksiyon gövde
- Buzlu cam
- Elektrostatik toz boyama

Material:

- Die-cast aluminium housing
- Frosted glass
- Electrostatic powder coated

Renk:

- Antrasit

Colour:

- Anthracite



JW933



E 27



Spiral

20 W



57x29x29 cm / 6 pcs

Y

IP

54

JW943



Malzeme:

- Alüminyum enjeksiyon gövde
- Opal polikarbonat difüzör
- Elektrostatik toz boyama

Material:

- Die-cast aluminium housing
- Frosted PC diffuser
- Electrostatic powder coated

Renk:

- Antrasit

Colour:

- Anthracite

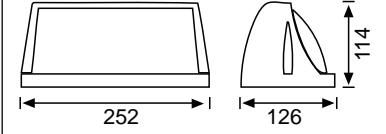

E 27



Dulux Star

20 W



252x126x114 / 20 pcs

Y

IP

54

JW952



Malzeme:

- Alüminyum enjeksiyon gövde
- Isıya dayanıklı cam difüzör
- Elektrostatik toz boyama

Material:

- Die-cast aluminium housing
- Tempered clear glass diffuser
- Electrostatic powder coated

Renk:

- Antrasit

Colour:

- Anthracite

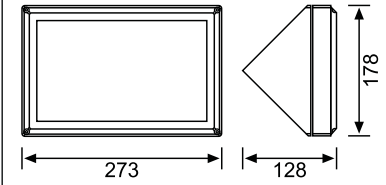

E 27

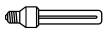

Dulux Star

2x20 W



47x32x31 cm / 6 pcs

Y

IP

54

JW969



Malzeme:

- Alüminyum enjeksiyon gövde
- Opal polikarbonat difüzör
- Elektrostatik toz boyama

Material:

- Die-cast aluminium housing
- Opal polycarbonate diffuser
- Electrostatic powder coated

Renk:

- Gümüş Gri

Colour:

- Silver Gray

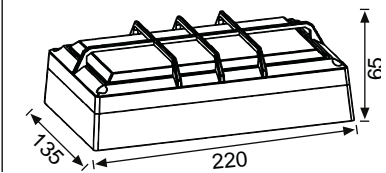

E 27

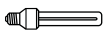

Dulux Star

15 W



37x29x47 cm / 20 pcs

Y

IP

54

JW939

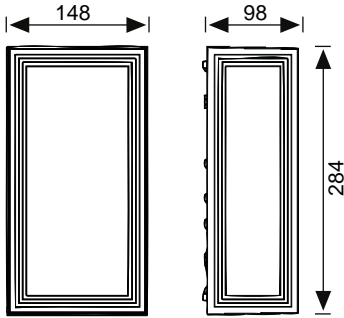
**Malzeme:**

- Alüminyum enjeksiyon gövde
- Opal polikarbonat difüzör
- Elektrostatik toz boyama

Material:

- Die-cast aluminium housing
- Opal polycarbonate diffuser
- Electrostatic powder coated

Renk:

- Antrasit
- Pas

Colour:

- Anthracite
- Rusty



E 27



Dulux Star

2x20 W



44.5x32.5x31 cm / 8 pcs

Y

IP

54

JW934

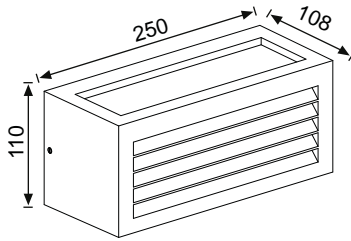
**Malzeme:**

- Alüminyum enjeksiyon gövde
- Opal polikarbonat difüzör
- Elektrostatik toz boyama

Material:

- Die-cast aluminium housing
- Opal polycarbonate diffuser
- Electrostatic powder coated

Renk:

- Antrasit
- Pas

Colour:

- Anthracite
- Rusty

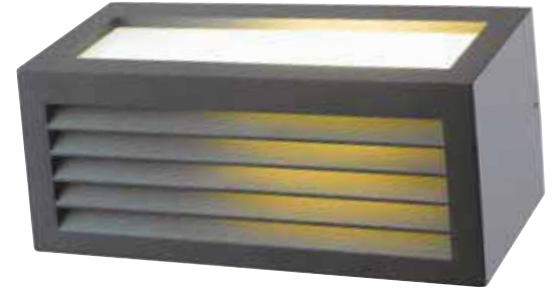

E 27



Spiral

20 W



50x25.5x28 cm / 8 pcs

Y

IP

54

JW962

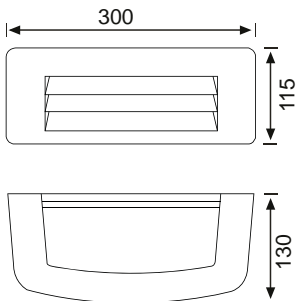
**Malzeme:**

- Alüminyum enjeksiyon gövde
- Opal polikarbonat difüzör
- Elektrostatik toz boyama

Material:

- Die-cast aluminium housing
- Opal polycarbonate diffuser
- Electrostatic powder coated

Renk:

- Antrasit

Colour:

- Anthracite



E 27



Dulux Star

20 W



50x29x32 cm / 8 pcs

Y

IP

54

JW700



Malzeme:

- Alüminyum enjeksiyon gövde
- Opal polikarbonat difüzör
- Elektrostatik toz boyama

Material:

- Die-cast aluminium housing
- Opal polycarbonate diffuser
- Electrostatic powder coated

Renk:

- Antrasit

Colour:

- Anthracite

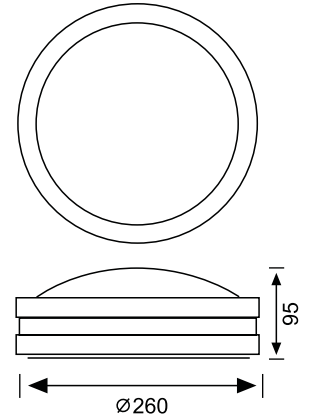



LW975

LW402



Malzeme:

- Alüminyum enjeksiyon gövde
- Elektrostatik toz boyama
- Dahili LED sürücülü
- Buzlu ısıya dayanıklı cam
- Plastik kör kasalı

Material:

- Die-cast aluminium housing
- Electrostatic powder coated
- Built-in Led driver
- Frosted tempered glass
- With plastic sleeve

Renk:

- Antrasit

Colour:

- Anthracite

CREE inside

LED

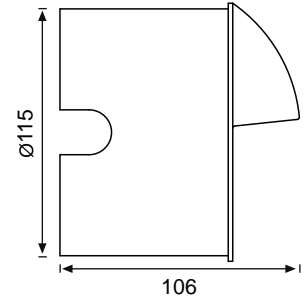

LED Tipi	Renk Sıcaklığı	Işık Akısı	Sistem Gücü	Voltaj	Ø	Yükseklik	Y	IP
Cree LED	3000 K	150 lm	3 W	230 V	Ø115 mm	25.5x25.5x37 cm / 12 pcs		54

LW425



Malzeme:

- Alüminyum enjeksiyon gövde
- Elektrostatik toz boyama
- Dahili LED sürücülü
- Plastik kör kasalı

Material:

- Die-cast aluminium housing
- Electrostatic powder coated
- Built-in LED driver
- With plastic sleeve

Renk:

- Gümüş Gri

Colour:

- Silver Gray

EDISON inside

LED

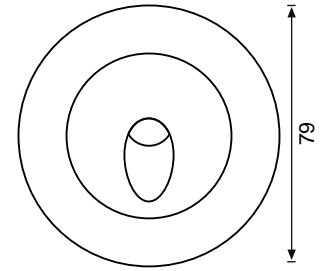

LED Tipi	Renk Sıcaklığı	Işık Akısı	Sistem Gücü	Voltaj	Ø	Açı	Yükseklik	Y	IP
Edison Power LED	3000 K	150 lm	3 W	230 V	Ø75 mm	80°	31x21x30 cm / 18 pcs		65

LW985



Malzeme:

- Alüminyum gövde
- LED sürücülü
- Plastik kör kasalı

Material:

- Aluminium housing
- With LED driver
- With plastic sleeve

Renk:

- Titanyum Anodize

Colour:

- Anodized Titanium

CREE inside

LED

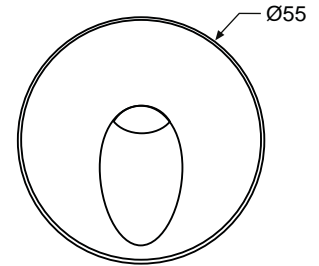

LED Tipi	Renk Sıcaklığı	Işık Akısı	Sistem Gücü	Voltaj	Ø	Yükseklik	Y	IP
Cree Power LED	3000 K	150 lm	3 W	230 V	Ø50 mm	45x19x36 cm / 50 pcs		54

LW984



Malzeme:

- Alüminyum gövde
- LED sürücülü
- Plastik kör kasalı

Material:

- Aluminium housing
- With LED driver
- With plastic sleeve

Renk:

- Titanyum Anodize

Colour:

- Anodized Titanium

CREE inside

LED

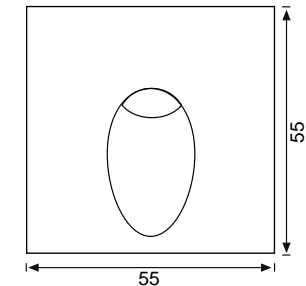

LED Tipi	Renk Sıcaklığı	Işık Akısı	Sistem Gücü	Voltaj	Ø	Yükseklik	Y	IP
Cree Power LED	3000 K	150 lm	3 W	230 V	Ø50 mm	45x19x36 cm / 50 pcs		54

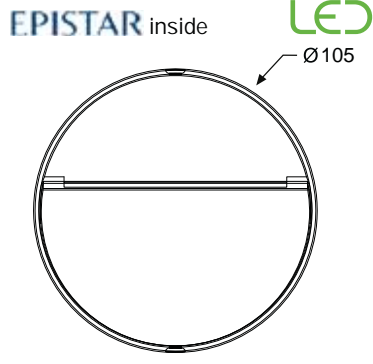



- Malzeme:**
- Alüminyum enjeksiyon gövde
 - Dahili LED sürücülü
 - Elektrostatik toz boyama

- Material:**
- Die-cast aluminium housing
 - Built-in LED driver
 - Electrostatic powder coated

- Renk:**
- Antrasit
- Colour:**
- Anthracite



LW444

LED Tipi	Renk Sıcaklığı	Işık Akısı	Sistem Gücü	Voltaj			Y	IP
Epistar SMD LED	3000 K	100 lm	2 W	230 V	120°	51x21x27 cm / 40 pcs		44

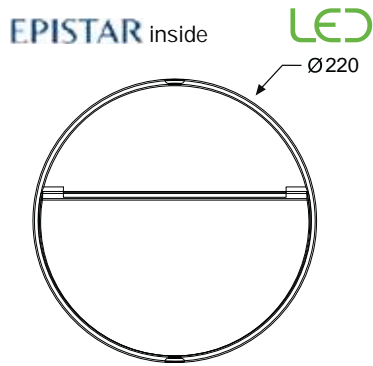



- Malzeme:**
- Alüminyum enjeksiyon gövde
 - Dahili LED sürücülü
 - Elektrostatik toz boyama

- Material:**
- Die-cast aluminium housing
 - Built-in LED driver
 - Electrostatic powder coated

- Renk:**
- Antrasit
- Colour:**
- Anthracite



LW454

LED Tipi	Renk Sıcaklığı	Işık Akısı	Sistem Gücü	Voltaj			Y	IP
Epistar SMD LED	3000 K	200 lm	3 W	230 V	120°	47x22x48 cm / 20 pcs		44

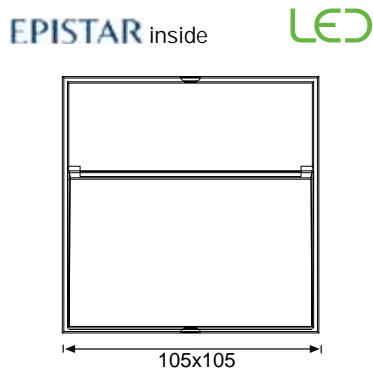

- Malzeme:**
- Alüminyum enjeksiyon gövde
 - Dahili LED sürücülü
 - Elektrostatik toz boyama

- Material:**
- Die-cast aluminium housing
 - Built-in LED driver
 - Electrostatic powder coated

- Renk:**
- Antrasit
- Colour:**
- Anthracite



LW443

LED Tipi	Renk Sıcaklığı	Işık Akısı	Sistem Gücü	Voltaj			Y	IP
Epistar SMD LED	3000 K	100 lm	2 W	230 V	120°	40x25x25 cm / 40 pcs		44

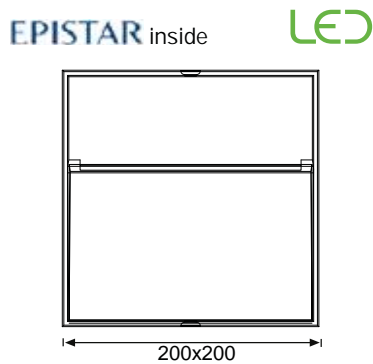

- Malzeme:**
- Alüminyum enjeksiyon gövde
 - Dahili LED sürücülü
 - Elektrostatik toz boyama

- Material:**
- Die-cast aluminium housing
 - Built-in LED driver
 - Electrostatic powder coated

- Renk:**
- Antrasit
- Colour:**
- Anthracite



LW453

LED Tipi	Renk Sıcaklığı	Işık Akısı	Sistem Gücü	Voltaj			Y	IP
Epistar SMD LED	3000 K	200 lm	3 W	230 V	120°	43x22x44 cm / 20 pcs		44

LW972



- Malzeme:**
- Alüminyum enjeksiyon gövde
 - Isıya dayanıklı cam
 - LED sürücülü
 - Metal kör kasalı

- Material:**
- Die-cast aluminium housing
 - Tempered glass
 - With LED driver
 - With metal sleeve

- Renk:**
- Titanyum Anodize

- Colour:**
- Anodized Titanium

EPSTAR inside

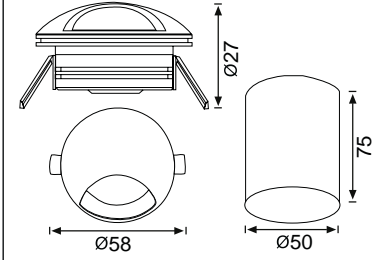

LED Tipi	Renk Sıcaklığı	Işık Akısı	Sistem Gücü	Voltaj			Y	IP
Epistar Power LED	3000 K	150 lm	3.5 W	230V	Ø50 mm	53x22x35 cm / 50 pcs		54

LW430



- Malzeme:**
- Alüminyum enjeksiyon gövde
 - Elektrostatik toz boyama
 - Polikarbonat difüzör
 - Dahili LED sürücülü
 - Plastik kör kasalı

- Material:**
- Die-cast aluminium housing
 - Electrostatic powder coated
 - Polycarbonate diffuser
 - Built-in LED driver
 - With plastic sleeve

- Renk:**
- Gümüş Gri

- Colour:**
- Silver Gray

EPSTAR inside

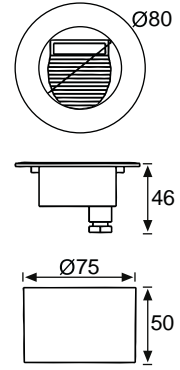

LED Tipi	Renk Sıcaklığı	Işık Akısı	Sistem Gücü	Voltaj			Y	IP
Epistar Power LED	3000 K	75 lm	1.5 W	230V		44x27x31 cm / 60 pcs		44

LW429



- Malzeme:**
- Alüminyum enjeksiyon gövde
 - Elektrostatik toz boyama
 - Polikarbonat difüzör
 - Dahili LED sürücülü
 - Plastik kör kasalı

- Material:**
- Die-cast aluminium housing
 - Electrostatic powder coated
 - Polycarbonate diffuser
 - Built-in LED driver
 - With plastic sleeve

- Renk:**
- Gümüş Gri

- Colour:**
- Silver Gray

EPSTAR inside

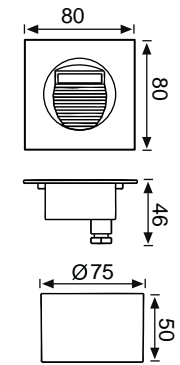

LED Tipi	Renk Sıcaklığı	Işık Akısı	Sistem Gücü	Voltaj			Y	IP
Epistar Power LED	3000 K	75 lm	1.5 W	230V		44x27x31 cm / 60 pcs		44

LED **NEW**

LW975

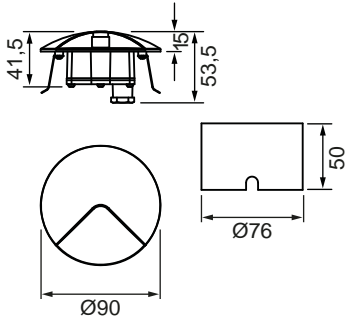
**Malzeme:**

- Alüminyum enjeksiyon gövde
- Plastik kör kasalı
- Dahili LED sürücülü
- Elektrostatik toz boyama

Material:

- Die-cast aluminium housing
- With plastic sleeve
- Built-in driver
- Electrostatic powder coated

Renk:

- Beyaz

Colour:

- White



LED Tipi	Renk Sıcaklığı	Işık Akısı	Sistem Gücü	Voltaaj
SMD LED	3000 K	150 lm	2 W	230 V

 52x21x28 cm / 30 pcs

Y

IP
44LED **EPISTAR** inside

LW977

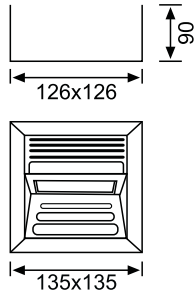
**Malzeme:**

- Alüminyum enjeksiyon gövde
- Elektrostatik toz boyama
- Dahili LED sürücülü
- Plastik kör kasalı

Material:

- Die-cast aluminium housing
- Electrostatic powder coated
- Built-in LED driver
- With plastic sleeve

Renk:

- Gümüş Gri

Colour:

- Silver Gray



LED Tipi	Renk Sıcaklığı	Işık Akısı	Sistem Gücü	Voltaaj
Epistar SMD LED	3000 K	150 lm	3 W	230V

 52x23.5x23 cm / 50 pcs

Y

IP
54LED **HARVATEK** inside

LW942

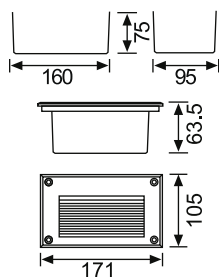
**Malzeme:**

- Alüminyum enjeksiyon gövde
- Isiya dayanıklı cam
- Elektrostatik toz boyama
- Dahili LED sürücülü
- Plastik kör kasalı

Material:

- Die-cast aluminium housing
- Tempered glass
- Electrostatic powder coated
- Built-in LED driver
- With plastic sleeve

Renk:

- Gümüş Gri

Colour:

- Silver Gray



LED Tipi	Renk Sıcaklığı	Işık Akısı	Sistem Gücü	Voltaaj
Harvatek SMD LED	3000 K	150 lm	3 W	230V

 120°

 37x21x22 cm / 6 pcs

Y

IP
54

LW401



Malzeme:

- Plastik gövde
- Paslanmaz çelik çerçeve 304 S.S.
- Buzlu polikarbonat difüzör
- Dahili LED sürücülü
- Plastik kör kasalı

Material:

- Plastic housing
- Stainless steel frame 304 S.S.
- Frosted polycarbonate diffuser
- Built-in LED driver
- With plastic sleeve

Renk:

- Paslanmaz Çelik

Colour:

- Stainless Steel

EPISTAR inside

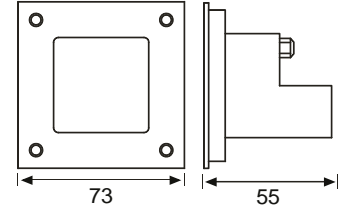

LED Tipi	Renk Sıcaklığı	Işık Akısı	Sistem Gücü	Voltaj			Y	IP
Epistar SMD LED	3000 K	50 lm	1 W	230V	68x68 mm	41x25x34 cm / 60 pcs		54

LW973



Malzeme:

- Alüminyum enjeksiyon gövde
- Paslanmaz çelik çerçeve 304 S.S.
- Isıya dayanıklı buzlu cam
- Dahili LED sürücülü
- Plastik kör kasalı

Material:

- Die-cast aluminium housing
- Stainless steel frame 304 S.S.
- Tempered and frosted glass
- Built-in LED driver
- With plastic sleeve

Renk:

- Paslanmaz Çelik

Colour:

- Stainless Steel

EPISTAR inside

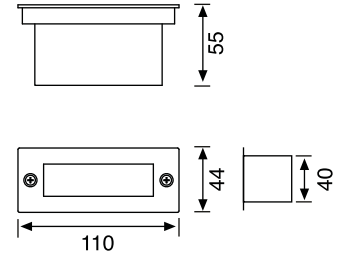

LED Tipi	Renk Sıcaklığı	Işık Akısı	Sistem Gücü	Voltaj			Y	IP
Epistar SMD LED	3000 K	50 lm	1.2 W	230V		28x26x32.5 cm / 50 pcs		54

LW974



Malzeme:

- Alüminyum enjeksiyon gövde
- Paslanmaz çelik çerçeve 304 S.S.
- Isıya dayanıklı buzlu cam
- Dahili LED sürücülü
- Plastik kör kasalı

Material:

- Die-cast aluminium housing
- Stainless steel frame 304 S.S.
- Tempered and frosted glass
- Built-in LED driver
- With plastic sleeve

Renk:

- Paslanmaz Çelik

Colour:

- Stainless Steel

EPISTAR inside

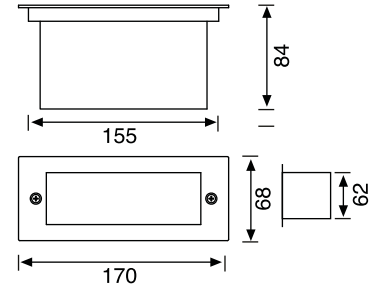

LED Tipi	Renk Sıcaklığı	Işık Akısı	Sistem Gücü	Voltaj			Y	IP
Epistar SMD LED	3000 K	75 lm	1.6 W	230V		39.5x38x38.5 cm / 40 pcs		54

JW672 SS



Malzeme:

- Alüminyum enjeksiyon gövde
- Buzlu cam
- Elektrostatik toz boyama
- Plastik kör kasalı

Material:

- Die-cast aluminium housing
- Frosted glass
- Electrostatic powder coated
- With plastic sleeve

Renk:

- Paslanmaz Çelik

Colour:

- Stainless Steel

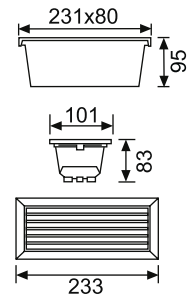

							Y	IP
E 27	Dulux Star	15 W				32.5x26x48.5 cm / 18 pcs		44

LED

SEOUL inside

LW426

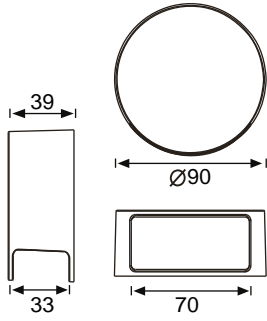
**Malzeme:**

- Alüminyum enjeksiyon gövde
- Isıya dayanıklı cam
- Elektrostatik toz boyama

Material:

- Die-cast aluminium housing
- Tempered glass
- Electrostatic powder coated

Renk:

- Antrasit

Colour:

- Anthracite



LED Tipi	Renk Sıcaklığı	Işık Akısı	Sistem Gücü	Voltaj	90°	52x30x22 cm / 50 pc	Y	IP 44
Seoul Star LED	3000 K	150 lm	4 W	230V				

LED

LW457

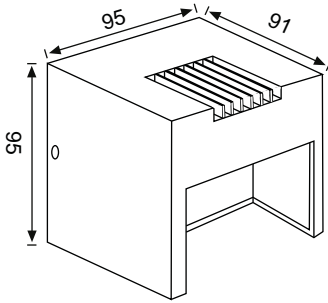
**Malzeme:**

- Alüminyum enjeksiyon gövde
- Dahili LED sürücülü
- Elektrostatik toz boyama

Material:

- Die-cast aluminium housing
- Built-in LED driver
- Electrostatic powder coated

Renk:

- Siyah & Altın

Colour:

- Black & Gold



LED Tipi	Renk Sıcaklığı	Işık Akısı	Sistem Gücü	Voltaj	42x32x23 cm / 24 pcs	Y	IP 55
COB LED	3000 K	300 lm	6 W	230V			

LED

LW458

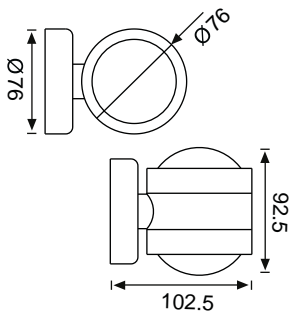
**Malzeme:**

- Paslanmaz çelik gövde
- Dahili LED sürücülü
- Şeffaf mercekli cam

Material:

- Stainless steel housing
- Built-in LED driver
- Clear convex glass

Renk:

- Paslanmaz Çelik

Colour:

- Stainless Steel



LED Tipi	Renk Sıcaklığı	Işık Akısı	Sistem Gücü	Voltaj	41.5x22x32 cm / 24 pcs	Y	IP 55
Power LED	3000 K	300 lm	2x3 W	230V			



LG989



JG844



LG986



JG841



JG956

JG821



- Malzeme:**
- Paslanmaz elik gövde
 - Opal polikarbonat difüzör
- Material:**
- Stainless steel housing
 - Opal polycarbonate diffuser

- Renk:**
- Paslanmaz elik
- Colour:**
- Stainless Steel

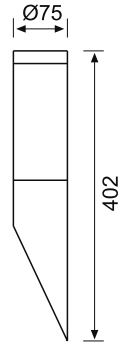

E 27



Dulux Star

15 W



42x34x43 cm / 20 pcs

Y

IP

44

JG822



- Malzeme:**
- Paslanmaz elik gövde
 - Opal polikarbonat difüzör
- Material:**
- Stainless steel housing
 - Opal polycarbonate diffuser

- Renk:**
- Paslanmaz elik
- Colour:**
- Stainless Steel

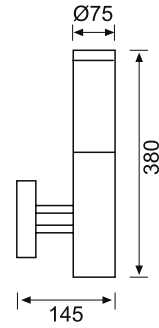

E 27



Dulux Star

15 W



56x41x47 cm / 12 pcs

Y

IP

44

JG813



- Malzeme:**
- Paslanmaz elik gövde
 - Opal polikarbonat difüzör
- Material:**
- Stainless steel housing
 - Opal polycarbonate diffuser

- Renk:**
- Paslanmaz elik
- Colour:**
- Stainless Steel

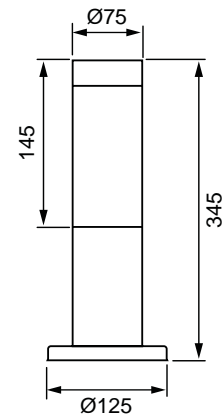

E 27



Duluxstar

15 W



56x35x42.5 cm / 12 pcs

Y

IP

44

JG823

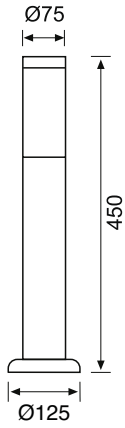
**Malzeme:**

- Paslanmaz çelik gövde
- Opal polikarbonat difüzör

Material:

- *Stainless steel housing*
- *Opal polycarbonate diffuser*

Renk:

- Paslanmaz Çelik

Colour:

- *Stainless Steel*



E 27

Dulux Star

15 W

56x42x48 cm / 12 pcs

Y

IP
44

JG824

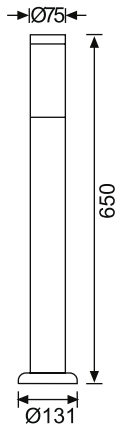
**Malzeme:**

- Paslanmaz çelik gövde
- Opal polikarbonat difüzör

Material:

- *Stainless steel housing*
- *Opal polycarbonate diffuser*

Renk:

- Paslanmaz Çelik

Colour:

- *Stainless Steel*



E 27

Dulux Star

15 W

67.5x42x56 cm / 12 pcs

Y

IP
44

JG835



Malzeme:

- Paslanmaz çelik gövde
- Polikarbonat difüzör

Material:

- Stainless steel housing
- Polycarbonate diffuser

Renk:

- Paslanmaz Çelik

Colour:

- Stainless Steel

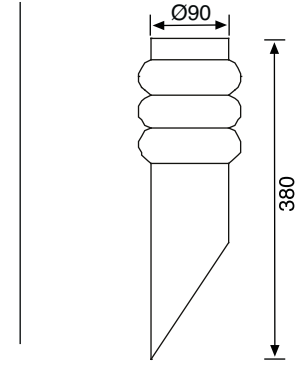

E 27



Dulux Star

15 W



42x32x41 cm / 12 pcs

Y

IP

44

JG836



Malzeme:

- Paslanmaz çelik gövde
- Polikarbonat difüzör

Material:

- Stainless steel housing
- Polycarbonate diffuser

Renk:

- Paslanmaz Çelik

Colour:

- Stainless Steel

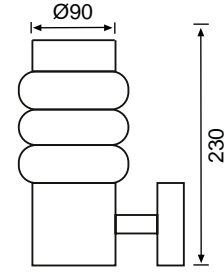

E 27



Dulux Star

15 W



44x20x26 cm / 6 pcs

Y

IP

44

JG837



Malzeme:

- Paslanmaz çelik gövde
- Polikarbonat difüzör

Material:

- Stainless steel housing
- Polycarbonate diffuser

Renk:

- Paslanmaz Çelik

Colour:

- Stainless Steel

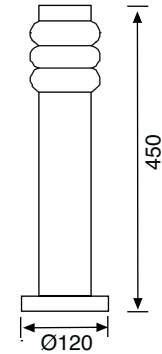

E 27

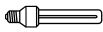

Dulux Star

15 W



48x39.5x27.5 cm / 6 pcs

Y

IP

44

JG838



Malzeme:

- Paslanmaz çelik gövde
- Polikarbonat difüzör

Material:

- Stainless steel housing
- Polycarbonate diffuser

Renk:

- Paslanmaz Çelik

Colour:

- Stainless Steel

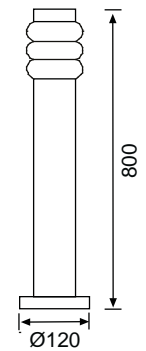

E 27

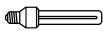

Dulux Star

15 W



83x29x42.5 cm / 6 pcs

Y

IP

44

JG811

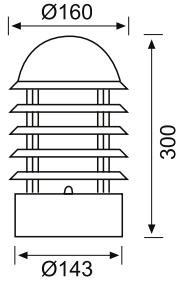
**Malzeme:**

- Paslanmaz çelik gövde
- Polikarbonat difüzör

Material:

- Stainless steel housing
- Polycarbonate diffuser

Renk:

- Paslanmaz Çelik

Colour:

- Stainless Steel



E 27



Dulux Star

20 W



51x32.5x35 cm / 6 pcs

Y

IP

44

JG810

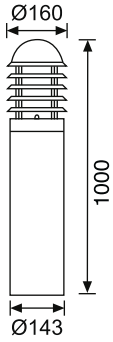
**Malzeme:**

- Paslanmaz çelik gövde
- Polikarbonat difüzör

Material:

- Stainless steel housing
- Polycarbonate diffuser

Renk:

- Paslanmaz Çelik

Colour:

- Stainless Steel



E 27

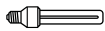

Dulux Star

20 W



103x35x52 cm / 6 pcs

Y

IP

44

JG839

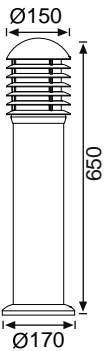
**Malzeme:**

- Alüminyum gövde
- Opal Polikarbonat difüzör
- Elektrostatik toz boyama

Material:

- Aluminium housing
- Opal polycarbonate diffuser
- Electrostatic powder coated

Renk:

- Antrasit

Colour:

- Anthracite



E 27



Spiral

20 W



68x37x38 cm / 4 pcs

Y

IP

54

JG947



Malzeme:

- Paslanmaz çelik gövde
- Opal Polikarbonat difüzör
- Elektrostatik toz boyama

Material:

- Stainless steel housing
- Opal polycarbonate diffuser
- Electrostatic powder coated

Renk:

- Antrasit

Colour:

- Anthracite

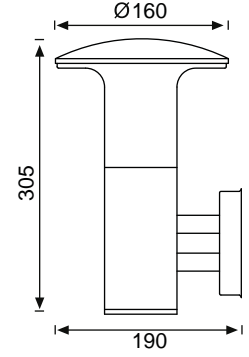

E 27



Dulux Star

11 W



53x42x34 cm / 6 pcs

Y

IP

44

JG948



Malzeme:

- Paslanmaz çelik gövde
- Opal Polikarbonat difüzör
- Elektrostatik toz boyama

Material:

- Stainless steel housing
- Opal polycarbonate diffuser
- Electrostatic powder coated

Renk:

- Antrasit

Colour:

- Anthracite

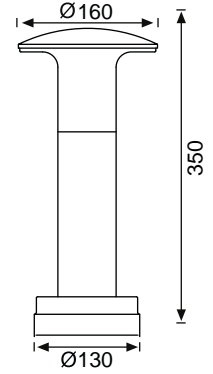

E 27

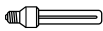

Dulux Star

11 W



53x36x38 cm / 6 pcs

Y

IP

44

JG949



Malzeme:

- Paslanmaz çelik gövde
- Opal Polikarbonat difüzör
- Elektrostatik toz boyama

Material:

- Stainless steel housing
- Opal polycarbonate diffuser
- Electrostatic powder coated

Renk:

- Antrasit

Colour:

- Anthracite

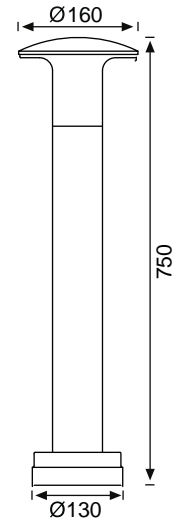

E 27

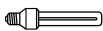

Dulux Star

11 W



78x36x53 cm / 6 pcs

Y

IP

44

JG846

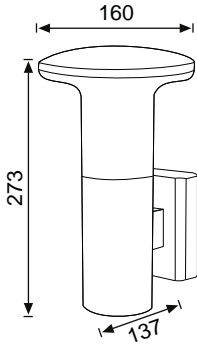
**Malzeme:**

- Alüminyum gövde
- Opal Polikarbonat difüzör
- Elektrostatik toz boyama

Material:

- Aluminium housing
- Opal polycarbonate diffuser
- Electrostatic powder coated

Renk:

- Antrasit

Colour:

- Anthracite



E 27



Dulux Star

20 W



68x48x48 cm / 8 pcs

Y

IP

54

JG844

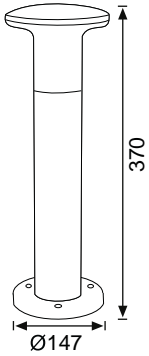
**Malzeme:**

- Alüminyum gövde
- Opal Polikarbonat difüzör
- Elektrostatik toz boyama

Material:

- Aluminium housing
- Opal polycarbonate diffuser
- Electrostatic powder coated

Renk:

- Antrasit

Colour:

- Anthracite



E 27



Dulux Star

20 W



46.5x35x53 cm / 6 pcs

Y

IP

54

JG845

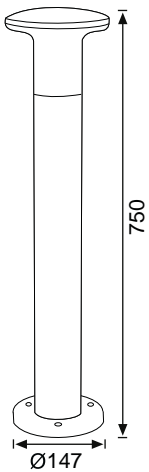
**Malzeme:**

- Alüminyum gövde
- Opal Polikarbonat difüzör
- Elektrostatik toz boyama

Material:

- Aluminium housing
- Opal polycarbonate diffuser
- Electrostatic powder coated

Renk:

- Antrasit

Colour:

- Anthracite



E 27



Dulux Star

20 W



86x35x36.5 cm / 4 pcs

Y

IP

54

JG931



- Malzeme:**
- Alüminyum enjeksiyon gövde
 - Opal Polikarbonat difüzör
 - Elektrostatik toz boyama

- Material:**
- Die-cast aluminium housing
 - Opal polycarbonate diffuser
 - Electrostatic powder coated

- Renk:**
- Paslanmaz Çelik
- Colour:**
- Stainless Steel

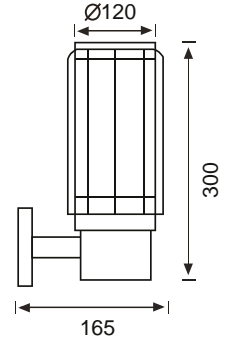

		20 W		Y	IP
E 27	Spiral		41.5x37x64cm / 12 pcs		44

JG932



- Malzeme:**
- Alüminyum enjeksiyon gövde
 - Opal Polikarbonat difüzör
 - Elektrostatik toz boyama

- Material:**
- Die-cast aluminium housing
 - Opal polycarbonate diffuser
 - Electrostatic powder coated

- Renk:**
- Antrasit
- Colour:**
- Anthracite

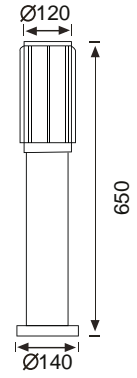

		20 W		Y	IP
E 27	Spiral		32x32x68cm / 4 pcs		44

JG840



- Malzeme:**
- Alüminyum enjeksiyon gövde
 - Opal Polikarbonat difüzör
 - Elektrostatik toz boyama

- Material:**
- Die-cast aluminium housing
 - Opal polycarbonate diffuser
 - Electrostatic powder coated

- Renk:**
- Antrasit
- Colour:**
- Anthracite

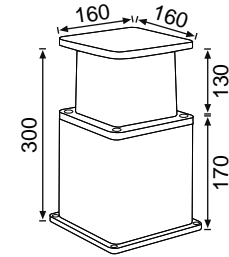

		23 W		Y	IP
E 27	Spiral		48.5x48.5x38.5 cm / 4 pcs		54

JG841



- Malzeme:**
- Alüminyum enjeksiyon gövde
 - Opal Polikarbonat difüzör
 - Elektrostatik toz boyama

- Material:**
- Die-cast aluminium housing
 - Opal polycarbonate diffuser
 - Electrostatic powder coated

- Renk:**
- Antrasit
- Colour:**
- Anthracite

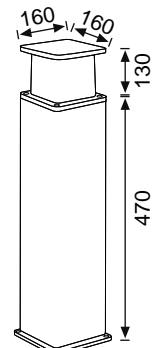

		23 W		Y	IP
E 27	Spiral		68x48.5x25.5 cm / 2 pcs		54

JG831

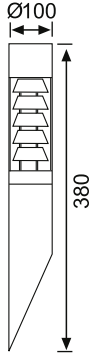
**Malzeme:**

- Paslanmaz çelik gövde
- Paslanmaz çelik reflektor
- Polikarbonat difüzör

Material:

- Stainless steel housing
- Stainless steel reflector
- Polycarbonate diffuser

Renk:

- Paslanmaz Çelik

Colour:

- Stainless Steel



E 27



Dulux Star

20 W



40.5x23.5x35 cm / 6 pcs

Y

IP

44

JG832

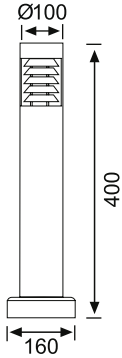
**Malzeme:**

- Paslanmaz çelik gövde
- Paslanmaz çelik reflektor
- Polikarbonat difüzör

Material:

- Stainless steel housing
- Stainless steel reflector
- Polycarbonate diffuser

Renk:

- Paslanmaz Çelik

Colour:

- Stainless Steel



E 27

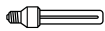

Dulux Star

20 W



51x34.5x43 cm / 6 pcs

Y

IP

44

JG833

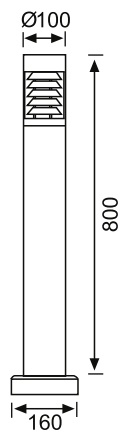
**Malzeme:**

- Paslanmaz çelik gövde
- Paslanmaz çelik reflektor
- Polikarbonat difüzör

Material:

- Stainless steel housing
- Stainless steel reflector
- Polycarbonate diffuser

Renk:

- Paslanmaz Çelik

Colour:

- Stainless Steel



E 27



Dulux Star

20 W



82.5x34.5x51.5 cm / 6 pcs

Y

IP

44

LG984



Malzeme:

- Alüminyum enjeksiyon gövde
- Elektrostatik toz boyama
- Dahili LED sürücülü

Material:

- Die-cast aluminium housing
- Electrostatic powder coated
- Built-in LED driver

Renk:

- Antrasit

Colour:

- Anthracite

CREE inside

LED

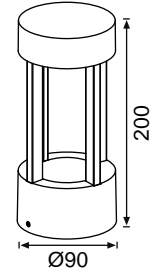

LED Tipi	Renk Sıcaklığı	Işık Akısı	Sistem Gücü	Voltaj		Y	IP
Cree COB LED	3000 K	500 lm	10 W	230V	44.5x20.5x30.5 cm / 12 pcs		54

LG986



Malzeme:

- Alüminyum enjeksiyon gövde
- Elektrostatik toz boyama
- Dahili LED sürücülü

Material:

- Die-cast aluminium housing
- Electrostatic powder coated
- Built-in LED driver

Renk:

- Antrasit

Colour:

- Anthracite

CREE inside

LED

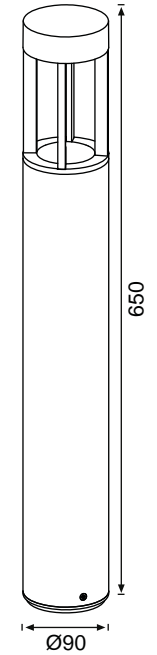

LED Tipi	Renk Sıcaklığı	Işık Akısı	Sistem Gücü	Voltaj		Y	IP
Cree COB LED	3000 K	500 lm	10 W	230V	30x20.5x68 cm / 6 pcs		54

LED

LG989

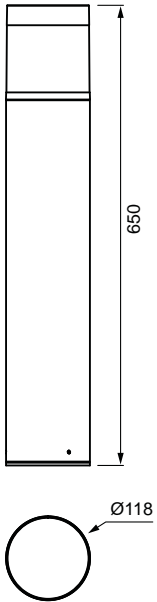
**Malzeme:**

- Alüminyum gövde
- Elektrostatik toz boyama
- Dahili LED sürücüsü

Material:

- Aluminium housing
- Electrostatic powder coated
- Built-in LED driver

Renk:

- Antrasit

Colour:

- Anthracite

LED Tipi	Renk Sıcaklığı	Işık Akısı	Sistem Gücü	Voltaj
SMD LED	3000 K	600 lm	12 W	230 V

68x28x28.5 cm / 4 pcs

Y

IP
65

JG930



- Malzeme:**
- Alüminyum enjeksiyon gövde
 - Opal Polikarbonat difüzör
 - Elektrostatik toz boyama

- Material:**
- Die-cast aluminium housing
 - Opal polycarbonate diffuser
 - Electrostatic powder coated

- Renk:**
- Antrasit
- Colour:**
- Anthracite

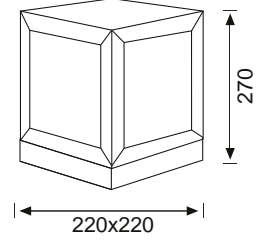

E 27



Spiral

23 W



48x48x29 cm / 4 pcs

Y

IP

44

JG933



- Malzeme:**
- Alüminyum enjeksiyon gövde
 - Prizmatik polikarbonat difüzör
 - Elektrostatik toz boyama

- Material:**
- Die-cast aluminium housing
 - Prismatic polycarbonate diffuser
 - Electrostatic powder coated

- Renk:**
- Antrasit
- Colour:**
- Anthracite

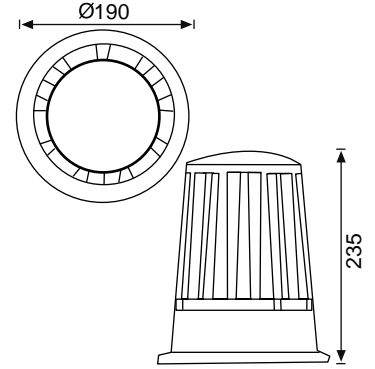

E 27



Spiral

23 W



41x41x52 cm / 8 pcs

Y

IP

54

JG934



- Malzeme:**
- Alüminyum enjeksiyon gövde
 - Prizmatik polikarbonat difüzör
 - Elektrostatik toz boyama

- Material:**
- Die-cast aluminium housing
 - Prismatic polycarbonate diffuser
 - Electrostatic powder coated

- Renk:**
- Antrasit
- Colour:**
- Anthracite

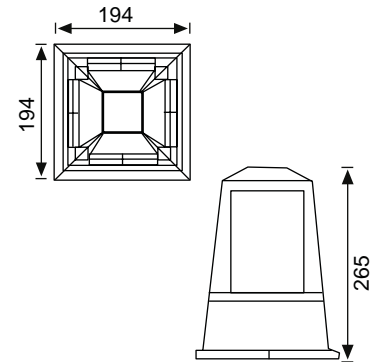

E 27



Spiral

23 W



42.5x42.5x55 cm / 8 pcs

Y

IP

54

JG956

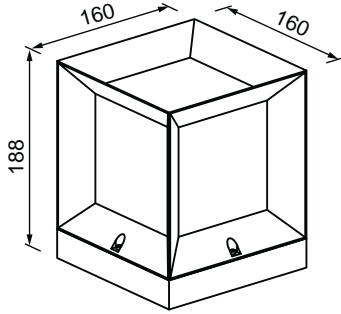
**Malzeme:**

- Alüminyum enjeksiyon gövde
- Opal Polikarbonat difüzör
- Elektrostatik toz boyama

Material:

- Die-cast aluminium housing
- Opal polycarbonate diffuser
- Electrostatic powder coated

Renk:

- Antrasit

Colour:

- Anthracite



E27

Spiral

20 W

51.5x35x21.5 cm / 6 pcs

Y

IP

44

JG935

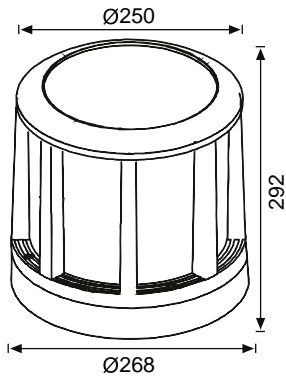
**Malzeme:**

- Alüminyum enjeksiyon gövde
- Opal Polikarbonat difüzör
- Elektrostatik toz boyama

Material:

- Die-cast aluminium housing
- Opal polycarbonate diffuser
- Electrostatic powder coated

Renk:

- Antrasit

Colour:

- Anthracite



E 27

Spiral

23 W

56.5x29x64 cm / 4 pcs

Y

IP

54

JG674

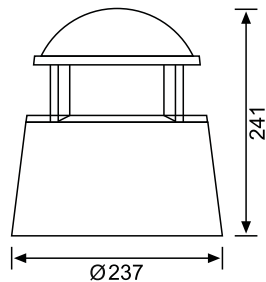
**Malzeme:**

- Alüminyum enjeksiyon gövde
- Buzlu cam difüzör
- Elektrostatik toz boyama

Material:

- Die-cast aluminium housing
- Frosted glass diffuser
- Electrostatic powder coated

Renk:

- Antrasit

Colour:

- Anthracite



E 27

Spiral

20 W

25.5x25.5x26 cm / 1 pc

Y

IP

65

LG981



- Malzeme:**
- Alüminyum enjeksiyon gövde
 - Dahili LED sürücülü
 - Elektrostatik toz boyama

- Material:**
- Die-cast aluminium housing
 - Built-in LED driver
 - Electrostatic powder coated

- Renk:**
- Antrasit
- Colour:**
- Anthracite

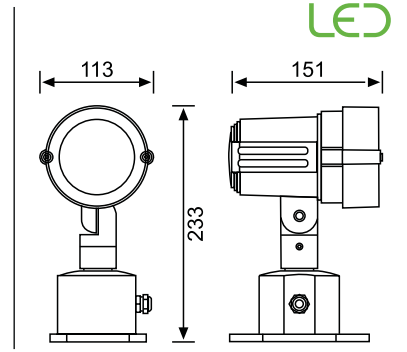

LED Tipi	Renk Sıcaklığı	Işık Akısı	Sistem Gücü	Voltaj	Y	IP
Power LED	Yeşil / 3000 K / 6500 K	350 lm	7 W	230V	30°	54

LG985



- Malzeme:**
- Alüminyum gövde
 - Paslanmaz çelik çerçeve 316 S.S
 - Dahili LED sürücülü
 - Plastik kör kasalı

- Material:**
- Aluminium housing
 - Stainless steel frame 316 S.S
 - Built-in LED driver
 - With steel sleeve

- Renk:**
- Antrasit
- Colour:**
- Anthracite

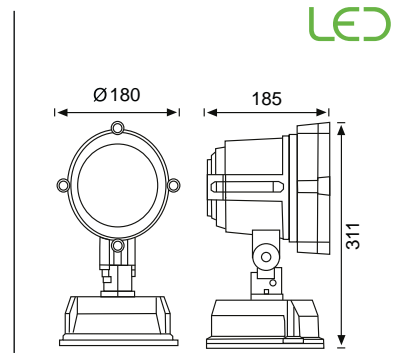

LED Tipi	Renk Sıcaklığı	Işık Akısı	Sistem Gücü	Voltaj	Y	IP
Power LED	3000 K	900 lm	18 W	230V	20°	54

JG683



- Malzeme:**
- Alüminyum enjeksiyon gövde
 - Isıya dayanıklı cam
 - Elektrostatik toz boyama

- Material:**
- Die-cast aluminium housing
 - Tempered clear glass
 - Electrostatic powder coated

- Renk:**
- Antrasit
- Colour:**
- Anthracite

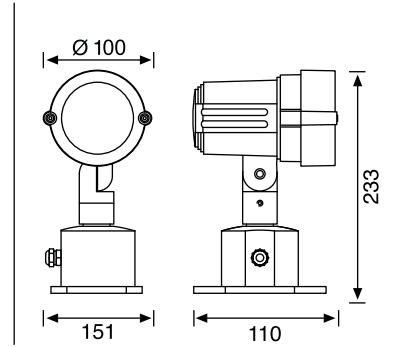

LED Tipi	LED Par	Sistem Gücü	Y	IP
GU 10	LED Par 16	5 W	Y	54

JG682



- Malzeme:**
- Alüminyum enjeksiyon gövde
 - Alüminyum reflektör 60°
 - Isıya dayanıklı cam
 - Elektrostatik toz boyama

- Material:**
- Die-cast aluminium housing
 - Aluminium reflector 60°
 - Tempered clear glass
 - Electrostatic powder coated

- Renk:**
- Antrasit
- Colour:**
- Anthracite

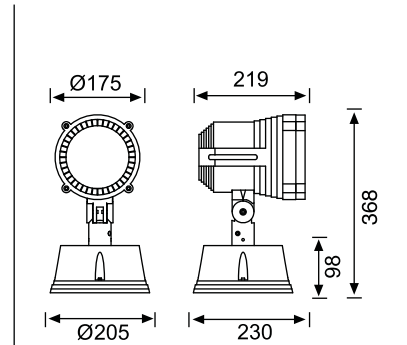

LED Tipi	LED Tipi	Sistem Gücü	Y	IP
G 12	HCI-T	70 W	Y	54

LED

EPISTAR inside

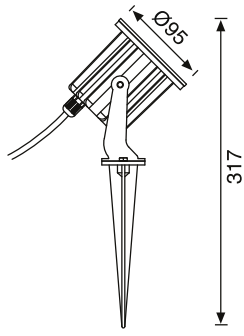
**Malzeme:**

- Alüminyum enjeksiyon gövde
- Paslanmaz çelik çerçeve 316 S.S.
- Dahili LED sürücülü

Material:

- Die-cast aluminium housing
- Stainless steel frame 316 S.S.
- Built-in LED driver

Renk:

- Antrasit

Colour:

- Anthracite



LG987

LED Tipi	Renk Sıcaklığı	Işık Akısı	Sistem Gücü	Voltaj	60°	31.5x19x42 cm / 12 pcs	Y	IP 65
Epistar COB LED	3000 K	500 lm	7 W	230V				

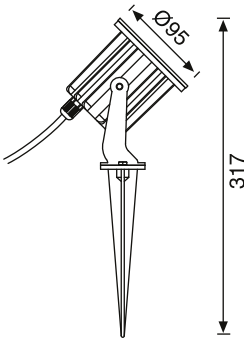
**Malzeme:**

- Alüminyum enjeksiyon gövde
- Paslanmaz çelik çerçeve 316 S.S.
- Isıya dayanıklı cam
- Polyester toz boya

Material:

- Die-cast aluminium housing
- Stainless steel frame 316 S.S.
- Tempered glass
- Polyester powder coated

Renk:

- Antrasit

Colour:

- Anthracite



JG655

GU 10	LED Par 16	5 W	25x25x29 cm / 12 pcs	Y	IP 65

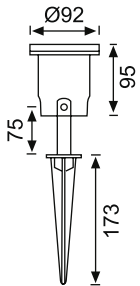
**Malzeme:**

- Alüminyum enjeksiyon gövde
- Isıya dayanıklı cam
- Polyester toz boya

Material:

- Die-cast aluminium housing
- Tempered glass
- Polyester powder coated

Renk:

- Siyah

Colour:

- Black



JG654

GU 10	LED Par 16	5 W	54.5x23.5x37 cm / 20 pcs	Y	IP 65

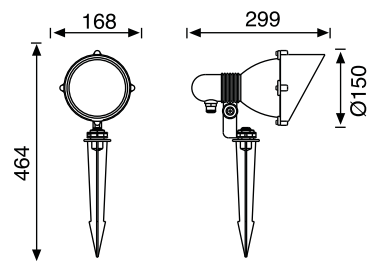
**Malzeme:**

- Alüminyum enjeksiyon gövde
- Alüminyum reflektör 30°
- Isıya dayanıklı cam
- Elektrostatik toz boyama

Material:

- Die-cast aluminium housing
- Aluminium reflector 30°
- Tempered clear glass
- Electrostatic powder coated

Renk:

- Antrasit

Colour:

- Anthracite



JG681

E 27	Par 38 / Spiral	80 / 20 W	54.5x37x33.5 cm / 6 pcs	Y	IP 65

JG661



Malzeme:
• Plastik gövde

Material:
• Plastic injection housing

Renk:
• Siyah

Colour:
• Black

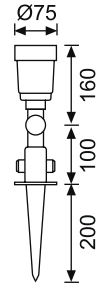

E 27



Par 38

80 W



50x42x46 cm / 30 pcs

Y

IP

24

JG662



Malzeme:
• Plastik gövde

Material:
• Plastic injection housing

Renk:
• Siyah

Colour:
• Black

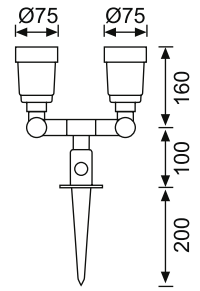

E 27



Par 38

2x80 W



84x40x35 cm / 20 pcs

Y

IP

24

JG658

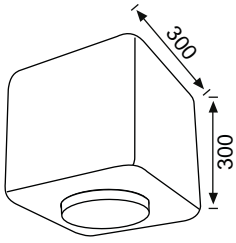
**Malzeme:**

- Polietilen difüzör
- 3 mt kablo ve fiő

Material:

- Polyethylene difüzör
- 3 mt rubber cable and plug

Renk:

- Beyaz

Colour:

- White

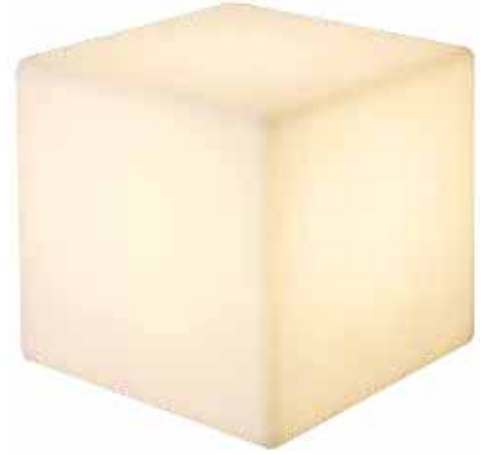

E 27

Spiral

23 W

33x33x37.5 cm / 1 pc

Y

IP
44

JG657

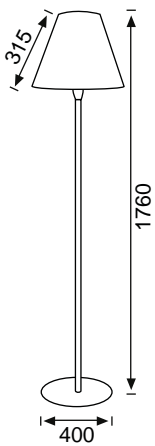
**Malzeme:**

- Polietilen difüzör
- 3 mt kablo ve fiő

Material:

- Polyethylene difüzör
- 3 mt rubber cable and plug

Renk:

- Kumlu Beyaz

Colour:

- Sandy White



E 27

Spiral

23 W

46.5x46.5x46 cm / 1 pc

Y

IP
44

LP401



Malzeme:

- Alüminyum enjeksiyon gövde
- Alüminyum reflektör
- Isıya dayanıklı cam
- Dahili LED sürücülü
- Elektrostatik toz boyama

Material:

- Die-cast aluminium housing
- Aluminium reflector
- Tempered glass
- Built-in LED driver
- Electrostatic powder coated

Renk:

- Gümüş

Colour:

- Silver

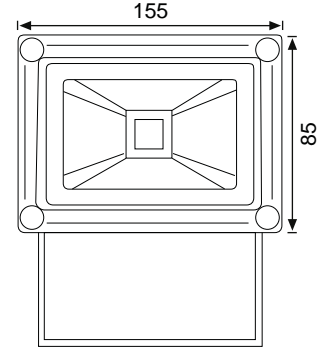

LED

LED Tipi	Renk Sıcaklığı	Işık Akısı	Sistem Gücü	Voltaj	120°	50x25x32 cm / 30 pcs	Y	IP 65
COB LED	3000 / 6500 K	610 lm	10 W	230 V				

LP403



Malzeme:

- Alüminyum enjeksiyon gövde
- Alüminyum reflektör
- Isıya dayanıklı cam
- Dahili LED sürücülü
- Elektrostatik toz boyama

Material:

- Die-cast aluminium housing
- Aluminium reflector
- Tempered glass
- Built-in LED driver
- Electrostatic powder coated

Renk:

- Gümüş

Colour:

- Silver

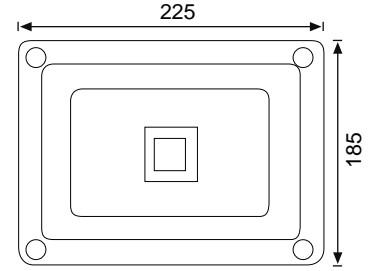

LED

LED Tipi	Renk Sıcaklığı	Işık Akısı	Sistem Gücü	Voltaj	120°	60x25x43 cm / 10 pcs	Y	IP 65
COB LED	3000 / 6500 K	1850 lm	30 W	230 V				

LP405



Malzeme:

- Alüminyum enjeksiyon gövde
- Alüminyum reflektör
- Isıya dayanıklı cam
- Dahili LED sürücülü
- Elektrostatik toz boyama

Material:

- Die-cast aluminium housing
- Aluminium reflector
- Tempered glass
- Built-in LED driver
- Electrostatic powder coated

Renk:

- Gümüş

Colour:

- Silver

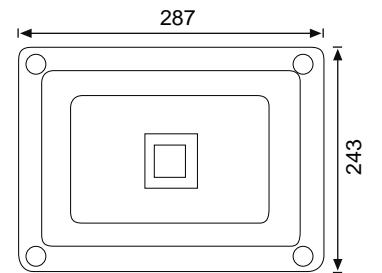

LED

LED Tipi	Renk Sıcaklığı	Işık Akısı	Sistem Gücü	Voltaj	120°	54x31x51 cm / 8 pcs	Y	IP 65
COB LED	3000 / 6500 K	3100 lm	50 W	230 V				

LED

LP413

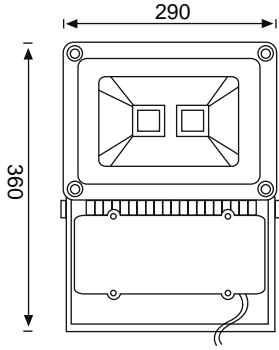
**Malzeme:**

- Alüminyum enjeksiyon gövde
- Alüminyum reflektör
- Isıya dayanıklı cam
- Dahili LED sürücülü
- Elektrostatik toz boyama

Material:

- Die-cast aluminium housing
- Aluminium reflector
- Tempered glass
- Built-in LED driver
- Electrostatic powder coated

Renk:

- Gümüş Gri

Colour:

- Silver Gray



LED Tipi	Renk Sıcaklığı	Işık Akısı	Sistem Gücü	Voltaj	120°	57x43x31 cm / 4 pcs	Y	IP 65
COB LED	3000 / 6500 K	6200 lm	2x50 W	230 V				

LED

LP414

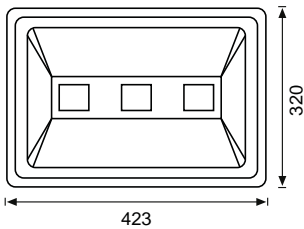
**Malzeme:**

- Alüminyum enjeksiyon gövde
- Alüminyum reflektör
- Isıya dayanıklı cam
- Dahili LED sürücülü
- Elektrostatik toz boyama

Material:

- Die-cast aluminium housing
- Aluminium reflector
- Tempered glass
- Built-in LED driver
- Electrostatic powder coated

Renk:

- Gümüş Gri

Colour:

- Silver Gray



LED Tipi	Renk Sıcaklığı	Işık Akısı	Sistem Gücü	Voltaj	63.5x28x28.5 cm / 4 pcs	Y	IP 65
COB LED	3000 K / 6500 K	8000 lm	3x50 W	230 V			

LP412



Malzeme:

- Alüminyum enjeksiyon gövde
- Alüminyum reflektör
- Isıya dayanıklı cam
- Dahili LED sürücülü
- Elektrostatik toz boyama
- Sensörlü

Material:

- Die-cast aluminium housing
- Aluminium reflector
- Tempered glass
- Built-in LED driver
- Electrostatic powder coated
- With IR sensor

Renk:

- Beyaz
- Siyah

Colour:

- White
- Black

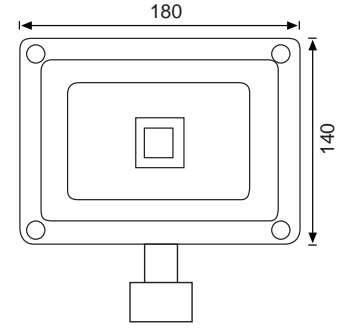

LED Tipi	Renk Sıcaklığı	Işık Akısı	Sistem Gücü	Voltaj			
San'an COB LED	3000 / 6500 K	1150 lm	20 W	230 V		42x42x35 cm / 12 pcs	Y IP 65

LP421



Malzeme:

- Alüminyum enjeksiyon gövde
- Alüminyum reflektör
- Isıya dayanıklı cam
- Dahili LED sürücülü
- Elektrostatik toz boyama

Material:

- Die-cast aluminium housing
- Aluminium reflector
- Tempered glass
- Built-in LED driver
- Electrostatic powder coated

Renk:

- Yeşil

Colour:

- Green

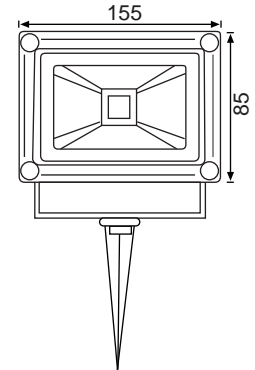

LED Tipi	Renk Sıcaklığı	Işık Akısı	Sistem Gücü	Voltaj			
San'an COB LED	Yeşil	1150 lm	20 W	230 V		59x34x30 cm / 30 pcs	Y IP 65

JP461



120° PIR Sensörlü 150 W Halojen Projektör

- Zaman ayarlı
- Lux ayarlı

Özellikler:

- Besleme: 220 ~ 240 V/AC
- Frekans: 50-60 Hz
- Işık hassasiyeti: 30 lux (Ayarlanabilir)
- Ortam rutubeti: \leftarrow 93 % RH nem
- Zaman aralığı: 6 sn. ~ 20 dk.
- Maksimum yükleme: 150 W
- Algılama: 12 m. 0.6-1.5 m/sn. hareket hızı
- Montaj yüksekliği: 1.8-2.5 m.

120° PIR 150 W Halogen Projector with Sensor

- Adjustable time delay
- Adjustable lux

Specifications:

- Power source: 220 ~ 240 V/AC
- Power frequency: 50-60 Hz
- Light sensivity: 30 lux (Adjustable)
- Working humidity: \leftarrow 93 % RH
- Time delay: 6 sec. ~ 20 min.
- Rated load: 150 W
- Detection distance: 12 m.
- Detection motion speed: 0.6-1.5 m./sec.
- Installation height: 1.8-2.5 m.

Renk:
• Siyah

Colour:
• Black

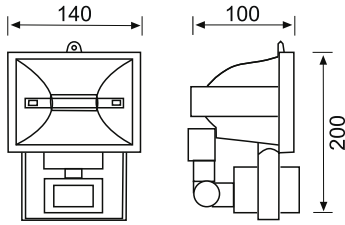

R 7s

Haloline

120 W

39.5x39x42 cm / 12 pcs

Y

IP
44

JP463



120° PIR Sensörlü 150 W Halojen Projektör

- Zaman ayarlı
- Lux ayarlı
- Algılama mesafesi ayarlı

Özellikler:

- Besleme: 220 ~ 240 V/AC
- Frekans: 50-60 Hz
- Işık hassasiyeti: 30 lux (Ayarlanabilir)
- Ortam nemi: \leftarrow 93 % RH
- Zaman aralığı: 6 sn. ~ 20 dk.
- Maksimum yükleme: 500 W
- Algılama: 6 ~ 12 m. 0.6-1.5 m/sn. hareket hızı
- Montaj yüksekliği: 1.8-2.5 m.

120° PIR 150 W Halogen Projector with Sensor

- Adjustable time delay
- Adjustable lux
- Adjustable detection distance

Specifications:

- Power source: 220 ~ 240 V/AC
- Power frequency: 50-60 Hz
- Light sensivity: 30 lux (Adjustable)
- Working humidity: \leftarrow 93% RH
- Time delay: 6 sec. ~ 20 min.
- Rated load: 500 W
- Detection distance: 6 ~ 12 m.
- Detection motion speed: 0.6-1.5 m./sec.
- Installation height: 1.8-2.5 m.

Renk:
• Siyah

Colour:
• Black

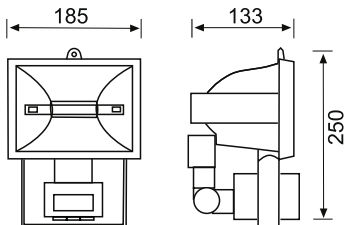

R 7s

Haloline

400 W

60x25.5x39.5 cm / 8 pcs

Y

IP
44

LW460

NICHIA inside **LED**



Malzeme:

- Alüminyum enjeksiyon gövde
- Paslanmaz çelik ayaklar 316 S.S.
- Dahili LED sürücülü

Material:

- Die-cast aluminium housing
- Stainless steel brackets 316 S.S.
- Built-in LED driver

Renk:

- Alüminyum

Colour:

- Aluminium

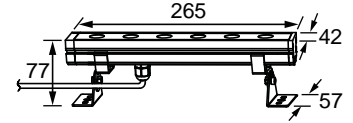

LED Tipi	Renk Sıcaklığı	Işık Akısı	Sistem Gücü	Voltaj	20°	40x43x19 cm / 8 pcs	Y	IP 65
Nichia COB LED	3000 K	430 lm	6x1 W	230 V				

LW461

NICHIA inside **LED**



Malzeme:

- Alüminyum enjeksiyon gövde
- Paslanmaz çelik ayaklar 316 S.S.
- Dahili LED sürücülü

Material:

- Die-cast aluminium housing
- Stainless steel brackets 316 S.S.
- Built-in LED driver

Renk:

- Alüminyum

Colour:

- Aluminium

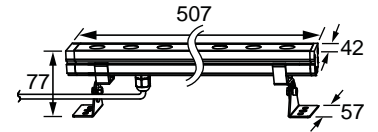

LED Tipi	Renk Sıcaklığı	Işık Akısı	Sistem Gücü	Voltaj	20°	65x33x20 cm / 6 pcs	Y	IP 65
Nichia COB LED	3000 K	870 lm	12x1 W	230 V				

LW462

NICHIA inside **LED**



Malzeme:

- Alüminyum enjeksiyon gövde
- Paslanmaz çelik ayaklar 316 S.S.
- Dahili LED sürücülü

Material:

- Die-cast aluminium housing
- Stainless steel brackets 316 S.S.
- Built-in LED driver

Renk:

- Alüminyum

Colour:

- Aluminium

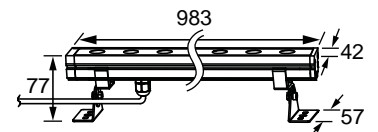

LED Tipi	Renk Sıcaklığı	Işık Akısı	Sistem Gücü	Voltaj	20°	115x23x20 cm / 4 pcs	Y	IP 65
Nichia COB LED	3000 K	1720 lm	24x1 W	230 V				

LED OSRAM inside

LW441

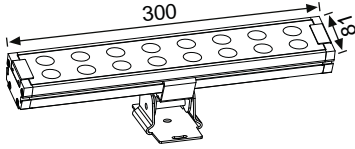
**Malzeme:**

- Alüminyum gövde
- Paslanmaz çelik ayak 316 S.S.
- Isıya dayanıklı cam
- Dahili LED sürücüsü

Renk:

- Beyaz
- Siyah
- a Renk:
- Gümüş Gri

Material:

- Aluminium housing
- Stainless steel bracket 316 S.S.
- Tempered glass
- Built-in LED driver

Colour:

- Silver Gray
- Colour:
- White
- Black

LED Tipi	Renk Sıcaklığı	Işık Akısı	Sistem Gücü	Voltaj	20°	43x15x16 cm / 2 pcs	Y	IP 65
Osram LED	3000 K	1400 lm	26.5 W	230V				

LED OSRAM inside

LW442

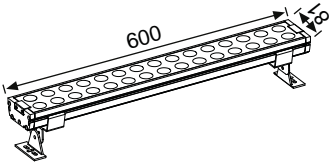
**Malzeme:**

- Alüminyum gövde
- Paslanmaz çelik ayak 316 S.S.
- Isıya dayanıklı cam
- Dahili LED sürücüsü

Renk:

- Gümüş Gri

Material:

- Aluminium housing
- Stainless steel bracket 316 S.S.
- Tempered glass
- Built-in LED driver

Colour:

- Silver Gray

LED Tipi	Renk Sıcaklığı	Işık Akısı	Sistem Gücü	Voltaj	20°	67x27x15 cm / 2 pcs	Y	IP 65
Osram LED	3000 K	2900 lm	50 W	230V				

JY001



Malzeme:

- Alüminyum enjeksiyon gövde
- Alüminyum reflektör
- Isıya dayanıklı cam
- Elektrostatik toz boyama

Material:

- Die-cast aluminium housing
- Aluminium reflector
- Tempered clear glass
- Electrostatic powder coated

Renk:

- Antrasit & Gümüş Gri

Colour:

- Anthracite & Silver Gray

SENSOR 

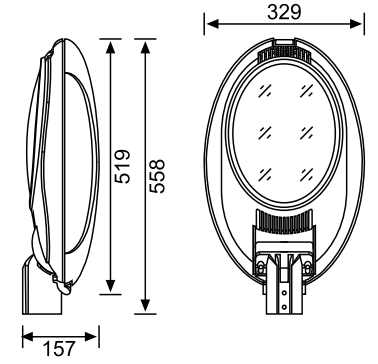

E 27/E 40



NAV-T/HQI-T

70-150 W



57x34x17 cm / 1 pc

Y

IP

65

JG685



Malzeme:

- Alüminyum enjeksiyon gövde
- Alüminyum reflektör 6°
- Dar açılı projektör
- Elektrostatik toz boyama

Material:

- Die-cast aluminium housing
- Aluminium reflector 6°
- Narrow beam projector
- Electrostatic powder coated

Renk:

- Antrasit

Colour:

- Anthracite

SENSOR 

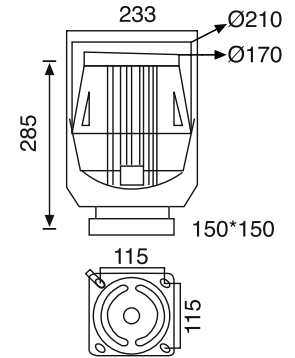

G 12



HCI-T

70 W



57x57x35.5 cm / 4 pcs

Y

IP

65



LA014

Driver options:
PHILIPS

LED

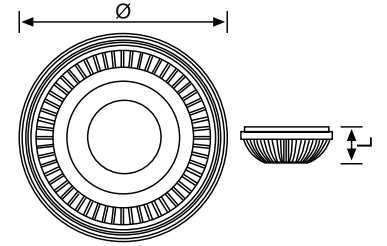

Kod Code	K	Max W	V	Boyutlar / Dimensions (mm)		Lm	Işık Açısı Beam Angle	Soket Socket	Kutu Adedi Quantity Per Carton	Y
				Ø	L					Kutu Ölçüleri Packaging Meas. (cm)
LA014	3000	30	230 V	111	80	2000	30°	Ar111	24	54x42x26

LED

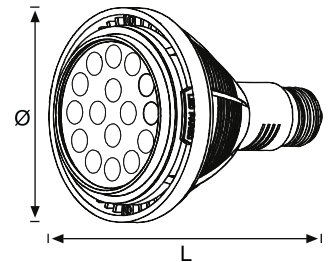

Kod Code	K	Max W	V	Boyutlar / Dimensions (mm)		Lm	Işık Açısı Beam Angle	Soket Socket	Kutu Adedi Quantity Per Carton	Y
				Ø	L					Kutu Ölçüleri Packaging Meas. (cm)
LA013	3000	36	230 V	95	143	2200	25°	E27	100	50.5x30x22

LED

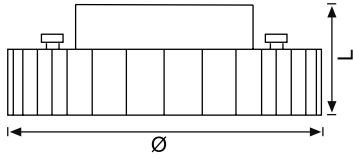

Kod Code	K	Max W	V	Boyutlar / Dimensions (mm)		Lm	Işık Açısı Beam Angle	Kutu Adedi Quantity Per Carton	Y
				Ø	L				Kutu Ölçüleri Packaging Meas. (cm)
LA011	3000	5	230 V	75	22	450	120°	100	26x38x17

LED

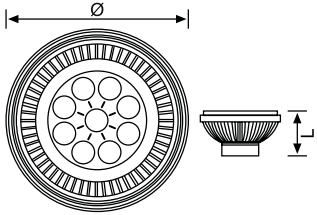

Kod Code	Açıklama Description	Max W	V	Boyutlar / Dimensions (mm)		Lm	LED	K	Işık Açısı Beam Angle	Kutu Adedi Quantity Per Carton	Y
				Ø	L						Kutu Ölçüleri Packaging Meas. (cm)
LA009 B	AR 111 LED sürücülü AR 111 LED with driver	12	230	111	70	980	9	6000	38°	20	59x24.2x17.9
LA009 S	AR 111 LED sürücülü AR 111 LED with driver	12	230	111	70	920	9	3000	38°	20	59x24.2x17.9

LED

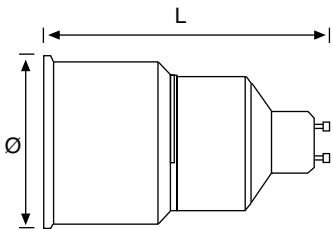

Kod Code	Açıklama Description	Max W	V	Soket Socket	Boyutlar / Dimensions (mm)		Lm	Ra	K	Ortalama Ömür/Saat Average Life/Hours	Kutu Adedi Quantity Per Carton	Y
					Ø	L						Kutu Ölçüleri Packaging Meas. (cm)
JA211 B	GU 10 duylu Kompakt Floresan Compact Fluorescent with GU 10 base	11	230	GU10	50	76	150	> 80	6500	6000	100	55x27.5x21
JA211 S	GU 10 duylu Kompakt Floresan Compact Fluorescent with GU 10 base	11	230	GU10	50	76	150	> 80	2700	6000	100	55x27.5x21



LED

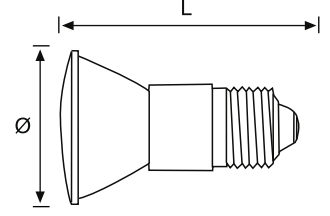

Kod Code	Led Rengi Emitting Colour	Max W	V	Soket Socket	Boyutlar / Dimensions (mm)		Lm	Lux	LED	Kutu Adedi Quantity Per Carton	Y
					Ø	L					Kutu Ölçüleri Packaging Meas. (cm)
LA480 K	Kırmızı/Red	2	220	E27	50	72	20-30	160-200	18	100	60x29x20
LA480 Y	Yeşil/Green	2	220	E27	50	72	20-30	160-200	18	100	60x29x20
LA480 S	Sarı/Yellow	2	220	E27	50	72	20-30	160-200	18	100	60x29x20



LED

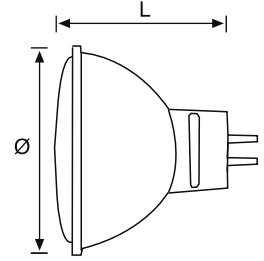

Kod Code	Led Rengi Emitting Colour	Max W	V	Soket Socket	Boyutlar / Dimensions (mm)		Lm	Lux	LED	Kutu Adedi Quantity Per Carton	Y
					Ø	L					Kutu Ölçüleri Packaging Meas. (cm)
LA682 M	Mavi /Blue	2	12	GU5.3	50	49	6-11	80-110	20	100	59x28.5x16.5
LA683 Y / LA682 Y	Yeşil / Green	2	220/12	GU5.3	50	49	18-25	140-200	20	100	59x28.5x16.5



LED

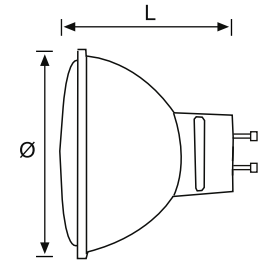

Kod Code	Led Rengi Emitting Colour	Max W	V	Soket Socket	Boyutlar / Dimensions (mm)		Lm	Lux	LED	Kutu Adedi Quantity Per Carton	Y
					Ø	L					Kutu Ölçüleri Packaging Meas. (cm)
LA687 M	Mavi /Blue	2	220	GU10	50	56.5	6-11	80-110	20	100	59x28.5x16.5

LED

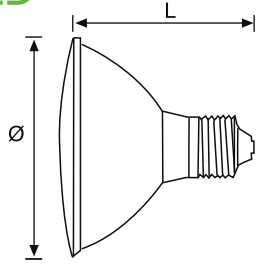

Kod Code	Led Rengi Emitting Colour	Max W	V	Soket Socket	Boyutlar / Dimensions (mm)		Lm	Lux	LED	Kutu Adedi Quantity Per Carton	Y
					Ø	L					Kutu Ölçüleri Packaging Meas. (cm)
LA481 M	Mavi /Blue	3	220	E27	95	91	15-20	55-70	50	45	57x24x37.5
LA481 B	Beyaz/White	3	220	E27	95	91	45-55	140-160	50	45	57x24x37.5

LED

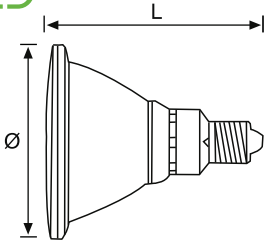

Kod Code	Led Rengi Emitting Colour	Max W	V	Soket Socket	Boyutlar / Dimensions (mm)		Lm	Lux	LED	Kutu Adedi Quantity Per Carton	Y
					Ø	L					Kutu Ölçüleri Packaging Meas. (cm)
LA431 M	Mavi /Blue	4	220	E27	122	134	18-28	80-100	70	20	76x31x32.5
LA431 B	Beyaz/White	4	220	E27	122	134	65-85	200-230	70	20	76x31x32.5
LA431 K	Kırmızı/Red	4	220	E27	122	134	15-25	60-70	70	20	76x31x32.5

LED

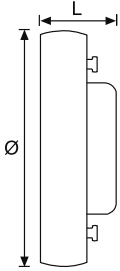

Kod Code	Led Rengi Emitting Colour	Max W	V	Soket Socket	Boyutlar / Dimensions (mm)		Lm	Lux	LED	Kutu Adedi Quantity Per Carton	Y
					Ø	L					Kutu Ölçüleri Packaging Meas. (cm)
LA533 K	Kırmızı/Red	2	220	GX53	75	25	12.6-15.4	7	36	100	47x35x22
LA533 Y	Yeşil /Green	2	220	GX53	75	25	33.3-40.7	30	36	100	47x35x22

Malzeme:

- GZ 10 seramik duy
- 15 cm silikon kablolu

- Renk:**
- Beyaz

Material:

- GZ 10 ceramic lampholder
- With 15 cm silicone cable

- Colour:**
- White

JZ010



49x29x22 cm / 1000 pcs

Y

IP 20

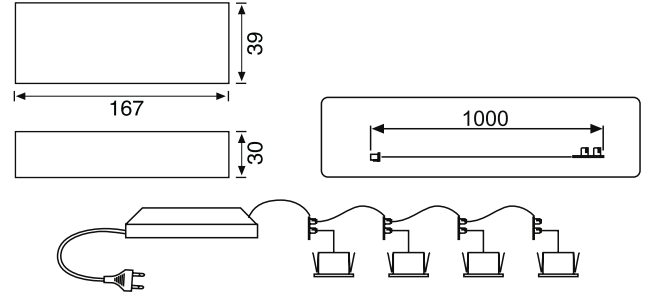

Kod Code	Işık Kaynağı / Light Source			700 mA LED sürücü / LED driver 700 mA			Y Kutu Ölçüleri Packaging Meas. (cm)	
	Max. W	mA	V	Boyutlar / Dimensions (mm)				Kutu Adedi Quantity Per Carton
				L	P	H		
LK991	3 W x 4	700	230	167	39	30	100	25x8x20

JK999



Malzeme:

- Askı takımı
- LD467 veya LD412 ile birlikte kullanılır

Material:

- Suspend kit
- Used with LD467 or LD412

JC105



Malzeme:

- Mandal seti
- LD467 veya LD412 ile birlikte kullanılır

Material:

- Clips kit
- Used with LD467 or LD412

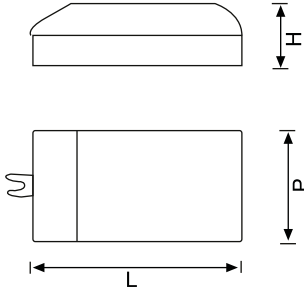

Kod Code	Işık Kaynağı / Light Source		TRAFO / TRANSFORMER				Y Kutu Ölçüleri Packaging Meas. (cm)	
	W	A	Boyutlar / Dimensions (mm)			Ağırlık Weight (kg)		Kutu Adedi Quantity Per Carton
			L	P	H			
JK261	60	0.24	114	35	21	0.051	200	46.5x33.5x15.7

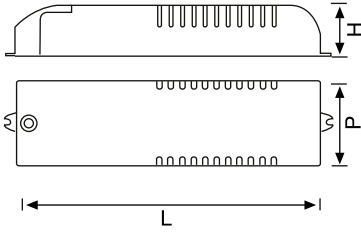

Kod Code	Işık Kaynağı / Light Source		TRAFO / TRANSFORMER				Y Kutu Ölçüleri Packaging Meas. (cm)	
	W	A	Boyutlar / Dimensions (mm)			Ağırlık Weight (kg)		Kutu Adedi Quantity Per Carton
			L	P	H			
JK260	60	0.25	130	33	20	0.072	100	35.5x28.5x13.5

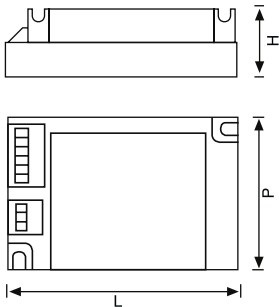

Kod Code	Işık Kaynağı / Light Source		ELEKTRONİK BALAST / ELECTRONIC BALLAST							Y Kutu Ölçüleri Packaging Meas. (cm)		
	W	A	V / Hz	Cosφ	Boyutlar / Dimensions (mm)			Ağırlık Weight (kg)	t max		EEI	Kutu Adedi Quantity Per Carton
					L	P	H					
JK218	2x18	0.18	230/50	≥0.95	114	73	33	0.102	70	A3	100	47.3x37.6x18

LED

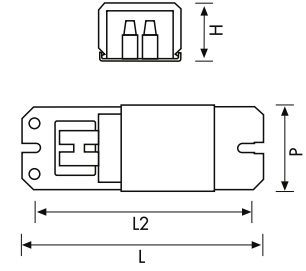

Kod Code	Işık Kaynağı / Light Source		BALAST / BALLAST										Y	
	W	A	V / Hz	Cosφ	Boyutlar / Dimensions (mm)				Ağırlık Weight (kg)	Δt/Δtan	Paralel Kapasitör Parallel Capacitor	Kutu Adedi Quantity Per Carton		Kutu Ölçüleri Packaging Meas. (cm)
					L	L2	P	H						
JK013	1x10-13	0.175	230/50	0.48	95	85	85	28	0.35	55/80	2.0	60	21.5x19.5x17.5	
JK018	1x18	0.220	230/50	0.50	95	85	85	28	0.35	55/125	2.0	60	21.5x19.5x17.5	

LED

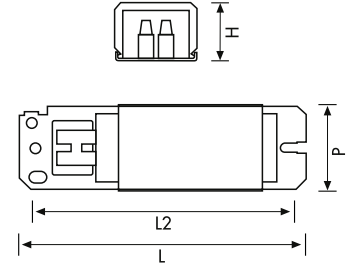

Kod Code	Işık Kaynağı / Light Source		BALAST / BALLAST										Y	
	W	A	V / Hz	Cosφ	Boyutlar / Dimensions (mm)				Ağırlık Weight (kg)	Δt/Δtan	Paralel Kapasitör Parallel Capacitor	Kutu Adedi Quantity Per Carton		Kutu Ölçüleri Packaging Meas. (cm)
					L	L2	P	H						
JK026	1x26	0.315	230/50	0.44	115	100	41	28	0.51	55/95	4.5	40	23.5x21.5x12	

LED

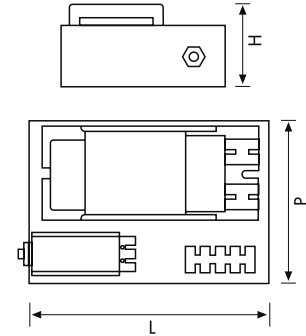

Kod Code	Işık Kaynağı / Light Source		BALAST / BALLAST										Y
	W	A	V / Hz	Cosφ	Boyutlar / Dimensions (mm)			Ağırlık Weight (kg)	Δt/Δtan	Paralel Kapasitör Parallel Capacitor	Kutu Adedi Quantity Per Carton	Kutu Ölçüleri Packaging Meas. (cm)	
					L	P	H						
JK253	35	0.53	230/50	≥0.85	160	110	65	1.60	70	8	10	61x19.5x18.5	
JK254	70	1.00	230/50	≥0.85	160	110	65	1.60	60	12	10	61x19.5x18.5	
JK256	250	3.00	230/50	≥0.40	160	110	65	3.20	75	32	6	37x23x18.5	

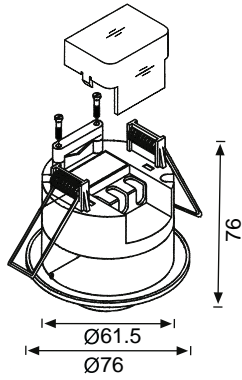
**120° ~ 360° Sıva Altı Hareket Sensörü**

- Zaman Ayarlı • Lux Ayarlı

Özellikler

- Besleme: 220 ~ 240 V/AC
- Frekans: 50-60 Hz
- Lux: < 3 Lux ~ 2000 Lux
- Çalışma nemi: < 93 % RH
- Çalışma ısısı: -10° ~ +40°C
- Zaman aralığı: 10 sn. ~ 7 dk.
- Maksimum yüklemeye: 1200 W
- Algılama mesafesi: Max. 6 m (24°)
- Hareketi algılama hızı: 0.6-1.5 m/sn
- Montaj yüksekliği: 2.2 ~ 4 m

- Renk** : • Beyaz
Colour : • White

120° ~ 360° Recessed Motion Sensor

- Adjustable Time Delay
- Adjustable Lux

Specifications

- Power source: 220 ~ 240 V/AC
- Power frequency: 50-60 Hz
- Lux: < 3 Lux ~ 2000 Lux
- Working humidity: < 93 % RH
- Working temperature: -10° ~ +40°C
- Time delay: 10 sec. ~ 7 min.
- Rated load: 1200 W
- Detection distance: Max. 6 m (24°)
- Detection motion speed: 0.6-1.5 m/sec
- Installation height: 2.2 ~ 4 m
- Power consumption: 0.45 W (static 0.1W)



44x43x22.5 cm / 50 pcs

JS485

360° Radar Tavan Sensörü

- Algılama Mesafesi Ayarlı
- Lux Ayarlı

Özellikler

- Besleme: 220 ~ 240 V/AC
- Frekans: 50-60 Hz
- HF sistemi: 5.8 GHz CW radar / ISM band
- Yayın gücü: < 10 mW
- Lux: < 10 Lux ~ 500 Lux
- Çalışma ısısı: -15° ~ +70°C
- Zaman aralığı: 10 sn. ~ 30 dk.
- Maksimum yüklemeye: 400 W
- Algılama mesafesi: 2 ~ 10 m (radii.)
- Hareketi algılama hızı: 0.6-1.5 m/sn
- Güç: 0.9 W

- Renk** : • Beyaz
Colour : • White

360° Radar Ceiling Sensor

- Adjustable Detection Distance
- Adjustable Lux

Specifications

- Power source: 220 ~ 240 V/AC
- Power frequency: 50-60 Hz
- HF system: 5.8 GHz CW radar / ISM band
- Transmission power: < 10 mW
- Lux: < 10 Lux ~ 500 Lux
- Working temperature: -15° ~ +70°C
- Time delay: 10 sec. ~ 30 min.
- Rated load: 400 W
- Detection distance: 2 ~ 10 m (radii.)
- Detection motion speed: 0.6-1.5 m/sec
- Power consumption: 0.9 W



52x31.5x22 cm / 100 pcs

JS486

İyonize Duman Sensörü/IonizationSmoke Sensor**Özellikler**

- Besleme: 9V/DC
- Alarm akımı: < 10 mA
- Alarm: > 85 db (3 m)
- Çalışma ısısı: -10°C ~ +50°C
- Zayıf pil uyarısı: 15 gün

Specifications

- Power source: 9V/DC
- Alarm current: < 10 mA
- Alarm sound: > 85 db (3 m)
- Work temperature: -10°C ~ +50°C
- Low battery alert: 15 days

- Renk:**
• Beyaz

- Colour:**
• White



56x39x27 cm / 60 pcs

JS480

360° Tavan Sensörü

- SMD Teknolojisi
- Zaman Ayarlı
- Lux Ayarlı
- Hassasiyet Ayarlı

Özellikler

- Besleme: 220 ~ 240 V/AC
- Frekans: 50-60 Hz
- Lux: < 3 Lux ~ gün ışığı
- Çalışma nemi: < 93 % RH
- Çalışma ısısı: 10° ~ 32°C
- Zaman aralığı: 5 sn. ~ 9 dk.
- Maksimum yüklemeye: 1200 W
- Algılama mesafesi: 10 m (24°)
- Hareketi algılama hızı: 0.6-1.5 m/sn
- Montaj yüksekliği: > 3 m
- Güç: 0.45 W (statik 0.1W)

- Renk** : • Beyaz
Colour : • White

360° Ceiling Sensor

- SMD Technology
- Adjustable Time Delay
- Adjustable Lux
- Adjustable Sensivity

Specifications

- Power source: 220 ~ 240 V/AC
- Power frequency: 50-60 Hz
- Lux: < 3 Lux ~ daylight
- Working humidity: < 93 % RH
- Working temperature: 10° ~ 32°C
- Time delay: 5 sec. ~ 9 min.
- Rated load: 1200 W
- Detection distance: 10 m (24°)
- Detection motion speed: 0.6-1.5 m/sec
- Installation height: > 3 m
- Power consumption: 0.45 W (static 0.1W)



50x39x36 cm / 60 pcs

JS476

JS475



140° ~ 180° Hareket Sensörü

- SMD Teknolojisi
- Zaman Ayarlı
- Lux Ayarlı
- Hassasiyet Ayarlı

Özellikler

- Besleme: 220 ~ 240 V/AC
- Frekans: 50-60 Hz
- Lux: < 5 Lux ~ 2000 Lux
- Çalışma nemi: < 93 % RH
- Çalışma ısısı: - 20° ~ +40°C
- Zaman aralığı: 5 sn. ~ 8 dk.
- Maksimum yüklem: 1200 W
- Algılama mesafesi: 2 ~12 m
- Hareketi algılama hızı: 0.6-1.5 m/sn
- Montaj yüksekliği: 1.8-2.5 m
- Güç: 0.45 W (statik 0.1W)

Renk : • Beyaz
Colour : • White

140° ~ 180° Motion Sensor

- SMD Technology
- Adjustable Time Delay
- Adjustable Lux
- Adjustable Sensivity

Specifications

- Power source: 220 ~ 240 V/AC
- Power frequency: 50-60 Hz
- Lux: < 5 Lux ~ 2000 Lux
- Working humidity: < 93 % RH
- Working temperature: - 20° ~ + 40°C
- Time delay: 5 sec. ~ 8 min
- Rated load: 1200 W
- Detection distance: 2 ~12 m
- Detection motion speed: 0.6-1.5 m/sec
- Installation height: 1.8-2.5 m
- Power consumption: 0.45 W (static 0.1W)



Y

47x40x38 cm / 36 pcs

JS479



Fotosel Röle / Photocell Relay

Özellikler

- Besleme: 220 V/50 Hz
- Çalışma: 2 ~ 100 lux (ayarlanabilir)
- Maksimum akım: 10A

Specifications

- Power source: 220 V/50 Hz
- Ambient light: 2 ~ 100 lux (adjustable)
- Rated current: 10A

Renk:

- Beyaz

Colour:

- White



Y

49x38x31 cm / 100 pcs

JK069



Malzeme:

- Alüminyum gövde
- LW966 sıva üstü montaj aparatı

Material:

- Aluminium housing
- LW966 surface mounting apparatus



Y

52x34x19 cm / 100 pcs

JK068



Malzeme:

- IP 68 su geçirmez bağlantı kutusu
- 1 giriş, 2 çıkış
- Max. 3x1.5 mm² kablo
- l:105 mm h:35 mm w:53 mm

Material:

- IP 68 waterproof connect box
- 1 input, 2 output
- Max. 3x1.5 mm² cable
- l:105 mm h:35 mm w:53 mm

Renk:

- Siyah

Colour:

- Black

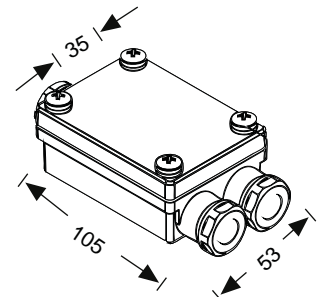

Y

IP
20

22x36x31 cm / 100 pcs

LED

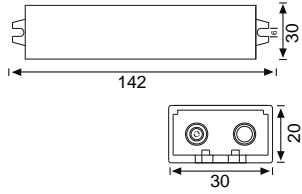

Kod Code	Işık Kaynağı / Light Source			LED sürücü / LED driver			Y	IP 67		
	W	A	V Input/Output	Boyutlar / Dimensions (mm)					Kutu Adedi Quantity Per Carton	Kutu Ölçüleri Packaging Meas. (cm)
				L	P	H				
LK965	25	2.1	AC 110-220 / DC 12	142	30	20	100	46x29.5x27		

LED

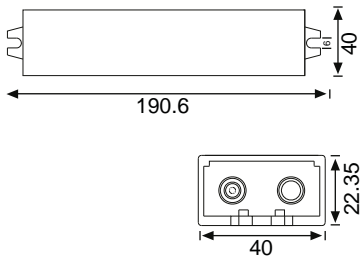

Kod Code	Işık Kaynağı / Light Source			LED sürücü / LED driver			Y	IP 67		
	W	A	V Input/Output	Boyutlar / Dimensions (mm)					Kutu Adedi Quantity Per Carton	Kutu Ölçüleri Packaging Meas. (cm)
				L	P	H				
LK973	60	5	AC 110-220 / DC 12	190	40	22	25	31x26x21		

LED

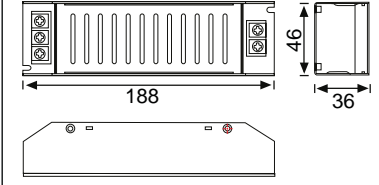

Kod Code	Işık Kaynağı / Light Source			LED sürücü / LED driver			Y	IP 20		
	W	A	V Input/Output	Boyutlar / Dimensions (mm)					Kutu Adedi Quantity Per Carton	Kutu Ölçüleri Packaging Meas. (cm)
				L	P	H				
LK975	60	5	AC 110-220 / DC 12	126	50	31	60	51x39x18		



- Malzeme:**
- Alüminyum gövde
 - 1.5 metre kablolu

- Material:**
- Aluminium housing
 - Supplied with 1.5 meter cable

- Renk:**
- Beyaz, Altın

- Colour:**
- White, Gold

LED

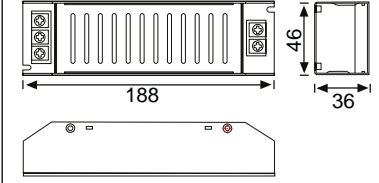

Kod Code	Işık Kaynağı / Light Source			LED sürücü / LED driver			Y	IP 20		
	W	A	V Input/Output	Boyutlar / Dimensions (mm)					Kutu Adedi Quantity Per Carton	Kutu Ölçüleri Packaging Meas. (cm)
				L	P	H				
LK968	120	10	AC 110-220 / DC 12	188	46	36	60	49x44x21.5		



- Malzeme:**
- Alüminyum gövde
 - 1.5 metre kablolu

- Material:**
- Aluminium housing
 - Supplied with 1.5 meter cable

- Renk:**
- Beyaz, Altın

- Colour:**
- White, Gold

LED

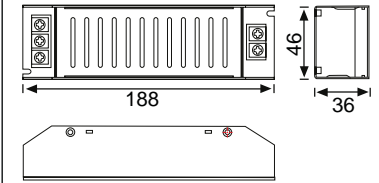

Kod Code	Işık Kaynağı / Light Source			LED TRAFOSU / LED DRIVER			Y	IP 20		
	W	A	V Input/Output	Boyutlar / Dimensions (mm)					Kutu Adedi Quantity Per Carton	Kutu Ölçüleri Packaging Meas. (cm)
				L	P	H				
LK976	200	16.6	AC 110-220 / DC 12	223	68	40	36	45x35x28		

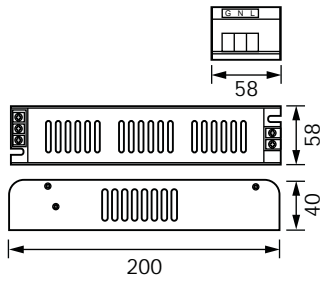
LED **NEW**

Kod Code	Işık Kaynağı / Light Source			LED sürücü / LED driver			Y	IP XX		
	W	A	V Input/Output	Boyutlar / Dimensions (mm)					Kutu Adedi Quantity Per Carton	Kutu Ölçüleri Packaging Meas. (cm)
				L	P	H				
LK977 (DC 12V)	150	12,5	AC 110-220 / DC 12	200	58	40	50	46x39x27		

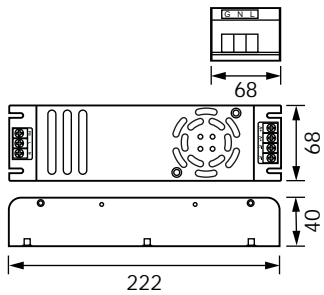
LED **NEW**

Kod Code	Işık Kaynağı / Light Source			LED sürücü / LED driver			Y	IP XX		
	W	A	V Input/Output	Boyutlar / Dimensions (mm)					Kutu Adedi Quantity Per Carton	Kutu Ölçüleri Packaging Meas. (cm)
				L	P	H				
LK978 (DC 12V)	360	30	AC 110-220 / DC 12	222	68	40	50	46x39x27		



LED

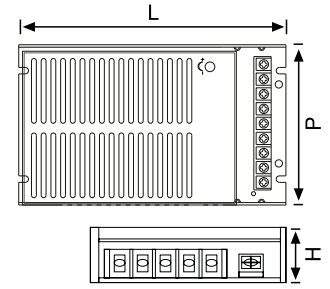

Kod Code	Işık Kaynağı / Light Source			LED sürücü / LED driver			Y	IP 20		
	W	A	V Input/Output	Boyutlar / Dimensions (mm)					Kutu Adedi Quantity Per Carton	Kutu Ölçüleri Packaging Meas. (cm)
				L	P	H				
LK974	200	16.66	AC 110-220 / DC 12	165	99	44	40	46x39.5x27		



LED

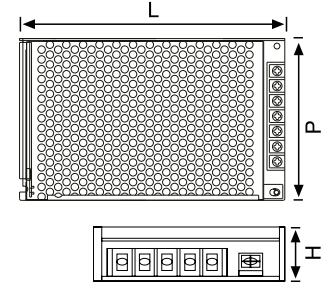

Kod Code	Işık Kaynağı / Light Source			LED sürücü / LED driver			Y	IP 20		
	W	A	V Input/Output	Boyutlar / Dimensions (mm)					Kutu Adedi Quantity Per Carton	Kutu Ölçüleri Packaging Meas. (cm)
				L	P	H				
LK966	60	5	AC 110-220 / DC 12	110	78	35	72	53x42x21		



LED

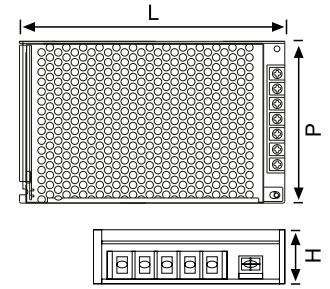

Kod Code	Işık Kaynağı / Light Source			LED sürücü / LED driver			Y	IP 20		
	W	A	V Input/Output	Boyutlar / Dimensions (mm)					Kutu Adedi Quantity Per Carton	Kutu Ölçüleri Packaging Meas. (cm)
				L	P	H				
LK967	100	8.33	AC 110-220 / DC 12	160	95	40	36	46x29.5x27		

LED

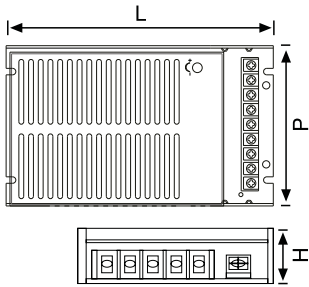

Kod Code	Işık Kaynağı / Light Source			LED sürücü / LED driver			Y	IP 20		
	W	A	V Input/Output	Boyutlar / Dimensions (mm)					Kutu Adedi Quantity Per Carton	Kutu Ölçüleri Packaging Meas. (cm)
				L	P	H				
LK970	200	16.66	AC 110-220 / DC 12	165	99	44	40	46x39.5x27		

LED

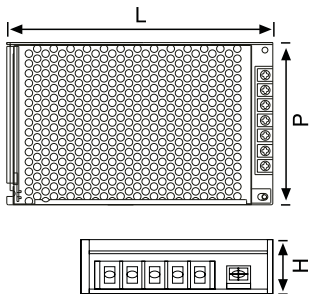

Kod Code	Işık Kaynağı / Light Source			LED sürücü / LED driver			Y	IP 20		
	W	A	V Input/Output	Boyutlar / Dimensions (mm)					Kutu Adedi Quantity Per Carton	Kutu Ölçüleri Packaging Meas. (cm)
				L	P	H				
LK971	250	20.83	AC 110-220 / DC 12	200	110	50	24	49x41x30		

GÖMME ARMATÜR MONTAJ KILAVUZU

Gömme armatür montajı diğer uygulamalardan daha dikkatli yapılmalıdır. Çünkü gömme armatürler diğerlerinden daha fazla tehlikeye maruz kalır.

Genel kurallar:

- Armatürü hiçbir zaman toprak seviyesinin altına yerleştirmeyin. Aksi halde armatür toz toprak ve yağışlı havalarda su içinde kalacaktır.
- Armatürü çiçek bitki ve ağaçların yakınına yerleştirmeyin. Bitkiler büyüdükçe armatürün ışığına mani olabilir, kökleri armatüre zarar verebilir.
- Armatürün toz toprak ve çamurla örülmesine izin vermeyin. Aksi halde izole edilen armatür aşırı ısınacaktır. Unutmayın ki birçok ampul ve bilhassa elektronik teçhizat ısıya aşırı duyarlıdır.

MONTAJ TALİMATI

1. Armatürün gömüleceği ve enerji kablosunun döşeneceği yeri kazın. Armatürün yer seviyesinden yukarıda ve su oturmayacak bir noktada olmasına dikkat edin.
2. Kazdığınız çukur armatür ebatlarından en az 8-10 cm daha derin ve geniş olmalıdır ki armatürün altına ve çevresine kum, çakıl veya mıcır drenaj malzemesi yerleştirilebilsin.
3. Armatürün ön halkasını, camını ve varsa balast kitini çıkarın.
4. Boşaltılmış olan deliğe 8-10 cm kum çakıl veya mıcır drenaj malzemesi koyun.
5. Enerji kablosunu armatüre vidalayın. Rakoru sıttıktan sonra su izolasyonunu sağlamak için armatürün dibine izolasyon malzemesi dökün.
6. Armatürünüz enerji kablosu monte edilmiş halde geldiyse kablo ek yerini izole edin.
7. Armatürü yerine koyduğunuzda armatür ön halkasının alt seviyesinin toprak seviyesinden yukarıda kalmasına dikkat edin.
8. Varsa balast kitini tekrar yerine monte edin. Balast kiti kablolarıyla klemenslerinin ısıya dayanıklı olmasına dikkat edin.
9. Ampülü duyuna takın.
10. Silikon contasına dikkat ederek armatürün camını takın ve ön halkasını vidalayın.
11. Armatüre enerji vererek deneyin.

PASLANMAZ ÇELİK BAKIMI ve KOROZYON**Paslanmaz çelik paslanır mı?**

Paslanmaz çelik normal çelikteki olduğu gibi yüzeyinden kazınabilen kızıl oksit lekeleriyle paslanmaz. Eğer ürünün yüzeyinde bu kızıl renkli pası görüyorsanız, bu yüksek ihtimalle paslanmaz çeliğin yüzeyine bulaşmış demir parçacıklarının paslanmasından kaynaklıdır.

Oluşan pas nasıl temizlenir?

Pasın oluştuğu yüzeye bakın ve paslanan parçayı geri kalanından ayırmanın mümkün olup olmadığını kontrol edin. Eğer demir yüzeye gömülü ise, %10 nitrik ve % 2 hidroflorik asidi oda sıcaklığında veya hafif ısıtılmış olarak kullanabilirsiniz. Bunu kullandıktan sonra bölgeyi bolca suyla yıkayınız. Bu işlem için marketlerde satılan temizleme asitleri de kullanılabilir.

Düzenli temizlik paslanmaz çeliği aşındırır mı?

Paslanmaz çelik üretilirken yüzeyinde krom parçacıkları bulunur, bu parçacıklar atmosferdeki oksijenle birleşerek paslanmaz çeliğin yüzeyinde ince bir krom oksit tabakası oluşturur ve bu tabaka çeliği paslanmaya karşı korur. Ancak yoğun kir ve yağlanma durumunda paslanmaya sebep olan çeşitli maddeler kirle birlikte çeliğin yüzeyinde hapsolür ve çeliğin düzenli olarak temizlenmemesi durumunda pas korumasını azaltır ve hatta yok eder. Paslanmaz çelik pek çok başka materyalin aksine temizlenmekle aşınmaz, tersine temizlenmesi ömrünü uzatır. Sünger, bez, su ve benzeri malzemelerle deterjanlı veya deterjansız olarak temizlenmesi mümkündür.

Paslanmaz ürünlerde neden korozyon oluşur?

Korozyona neden olan pek çok etken içinde çevresel etkenler de büyük rol oynar. Coğrafi konuma göre değişiklik gösteren iklim şartları çevresel etken adı altında incelenen önemli etkenlerden biridir.

Hangi iklim şartları korozyona neden olur?

Yüksek sıcaklık ve nemin birlikte etki ettiği en korozyon ortamı tropikal denizel ortamdır. Bu ortamda korozyon, sıcaklığın etkisi ile hızla artar. Sıcaklığın -25 °C ile 37 °C arasında, nemin ise 10-100 % arasında değiştiği ılıman iklimli bölgelerde endüstriyel kirlenmenin etkisi korozyonu hızlandıran etkidir. Duman ve sis gibi kalıntıları taşıyan ortam endüstriyel ortamlarda, endüstriyel kuruluşlardan yükselen gazlar havanın nemi ile birleşerek asit şeklinde yoğunlaşır ve korozyonu hızlandırır.

Sıcaklığın çok düşük olduğu ve düşük elektrokimyasal reaksiyonun olduğu ortamlarsa kutupsal ortamlardır. Bu ortamda elektrokimyasal ortamın çok düşük olmasına karşın çok soğuk durumdaki metal ısındığında nem toplanır. Bu da metalde korozyona neden olur.

Korozyonun oluşmadığı iklim var mı?

Nemin çok düşük olduğu ve korozyon olmadığı tek ortam ise çöl ortamıdır. Çöl ortamında nem olmadığından sıcaklığın da etkisi olmaz, böylelikle korozyon oluşmaz.

AYDINLIK DÜZEYLERİ

Yaşadığımız çeşitli mekanlarda sağlanması gereken ortalama aydınlık düzeyleri:

Ofisler:		
Genel ofis alanları	500	Lux
Açık ofisler	750	Lux
Çizim yapılan ofisler	1000	Lux
Bekleme salonları	200	Lux
Bilgi işlem merkezleri	300	Lux
Alışveriş merkezleri:		
Self servis mağazalar ve showromlar:	500	Lux
Mağazalar (genel)	300	Lux
Süpermarketler	750	Lux
Konser salonları, sinemalar, tiyatrolar:		
Genel	100	Lux
Fuaye	200	Lux
Müzeler ve sanat galerileri:		
Işığa duyarlı olmayan nesnelerin sergilenmesi	300	Lux
Işığa duyarlı nesnelerin serilenmesi	150	Lux
Eğitim:		
Sınıflar	500	Lux
Konferans salonları	300	Lux
Laboratuvarlar	500	Lux
Kütüphaneler	500	Lux

Konutlar, Hoteller, restoranlar:		
Yatak odaları (genel)	50	Lux
Yatakbaşı	200	Lux
Banyolar (genel)	100	Lux
Banyolar (ayna önü)	500	Lux
Oturma odaları (genel)	100	Lux
Oturma odaları (Okuma)	500	Lux
Merdivenler	100	Lux
Koridorlar	100	Lux
Mutfaklar (genel)	300	Lux
Mutfaklar (tezgah üstü)	500	Lux
Hastaneler:		
Gece	50	Lux
Gündüz	200	Lux
Muayene odaları	500	Lux
Personel odaları	100	Lux
Laboratuvarlar	500	Lux
Endüstriyel alanlar:		
Textil atölyeleri	750	Lux
Test ve kontrol noktaları	750	Lux
Dikiş atölyeleri	750	Lux
Deri atölyeleri	500	Lux
Mobilya atölyeleri	300	Lux
Metal işleme atölyeleri	300	Lux

DEŞARJ LAMBALARI

Deşarj lambalar(*) hakkında bazı teknik bilgiler:

Çalışma gerilimi : 2000 ve 3500 W'lar 400V diğerleri 230V şebeke gerilimi ile çalışır.

Maksimum verim için $\pm 3\%$ gerilim değişimlerine müsaade edilir.

İşletim Cihazları : Deşarjlı lambalar güçlerine uygun balast veya transformatör ve ateşleme cihazlarına ihtiyaç gösterirler.

Açma : Güçlerine göre enerji verildikten 2 – 15 dakika sonra tam ışık değerine ulaşırlar.

Tekrar ateşleme : Sıcak lambalar tekrar ateşleme için 3 – 15 dakika süreye ihtiyaç duyarlar.

Başlangıç Akımı : Tiplerine göre demaraj akımları yüksektir. (%35 ~ 90)

Devre koruma : Deşarjlı lambalar gecikmeli sigorta ile korunmalıdır.

Radyo parazitleri : Genellikle ateşleme zamanları dışında radyo parazitlerine sebep olmazlar.

Çalışma koşulları : Yanma odasının patlama riskinden dolayı kapalı armatür ile kullanılmalıdır (korumalı modelleri hariç). Yanma pozisyonları önemlidir, özellikle 250W ve yukarı güçlerde yanma pozisyonları için lambanın ilgili kataloğuna veya www.osram.com web sitesine bakınız.

Renk sapmaları : Çevresel etkenler gerilim, işletim cihazı, yanma pozisyonu ve armatür gibi sebeplerle renk farklılıkları oluşabilir.

Dimleme : Deşarjlı lambalar dimlenemezler.

Çalışma Ömrü : Lamba ışık rengi yeteri kadar iyi değilse, ışık değeri düşmüşse, Lamba ateşlemiyorsa, Periyodik olarak yanıp sönüyorsa, lamba ömrü sona ermiştir.

(*) Yüksek basınç metal halide lambalar, Yüksek basınçlı Sodyum buharlı lambalar, Yüksek basınç civa buharlı lambalar.

SEMBOLLER / SYMBOLS



DUY
LAMPHOLDER



GÜÇ
POWER



UZUNLUK
LENGTH



SIVA ALTI ARMATÜRLER İÇİN AÇILMASI GEREKEN DELİK ÖLÇÜSÜ
HOLE SIZE FOR RECESSED LUMINARIES



KUTU ÖLÇÜLERİ ve KUTU ADEDİ
PACKING MEASUREMENTS AND QUANTITY PER CARTON



KORUMA SINIFI
PROTECTION CLASS

- IP 20** 12 mm'den büyük katı cisimlere karşı koruma.
Protection against solid objects greater than 12 mm
- IP 24** 12 mm'den büyük katı cisimlere ve serpinti şeklindeki sıvılara karşı koruma.
Protection against solid objects greater than 12 mm and also splash of water.
- IP 33** 2.5 mm'den büyük katı cisimlere ve yağmura karşı koruma.
Protection against solid objects greater than 2.5 mm and also rain
- IP40** 1 mm'den büyük katı cisimlere karşı koruma.
Protection against solid objects greater than 1 mm
- IP 24** 1 mm'den büyük katı cisimlere ve serpinti şeklindeki sıvılara karşı koruma.
Protection against solid objects greater than 1 mm and also splash of water
- IP 54** Toza ve serpinti şeklindeki sıvılara karşı koruma.
Protection against dust and also splash of water
- IP 55** Toza ve fışkıran sıvılara karşı koruma.
Protection against dust and also jet of water
- IP 65** Toz geçirmezlik ve fışkıran sıvılara karşı koruma.
Complete dust proof with protection against jet of water
- IP 66** Toz geçirmezlik ve dalgalara karşı koruma.
Complete dust proof with protection against waves
- IP 67** Toz geçirmezlik ve suya daldırmaya karşı koruma.
Complete dust proof with protection against immersion
- IP 68** Toz geçirmezlik ve su altında kalmaya karşı koruma
Complete dust proof with protection against submersion

BANYOLARDA IP UYGULAMALARI / IP-ZONES IN BATHROOM

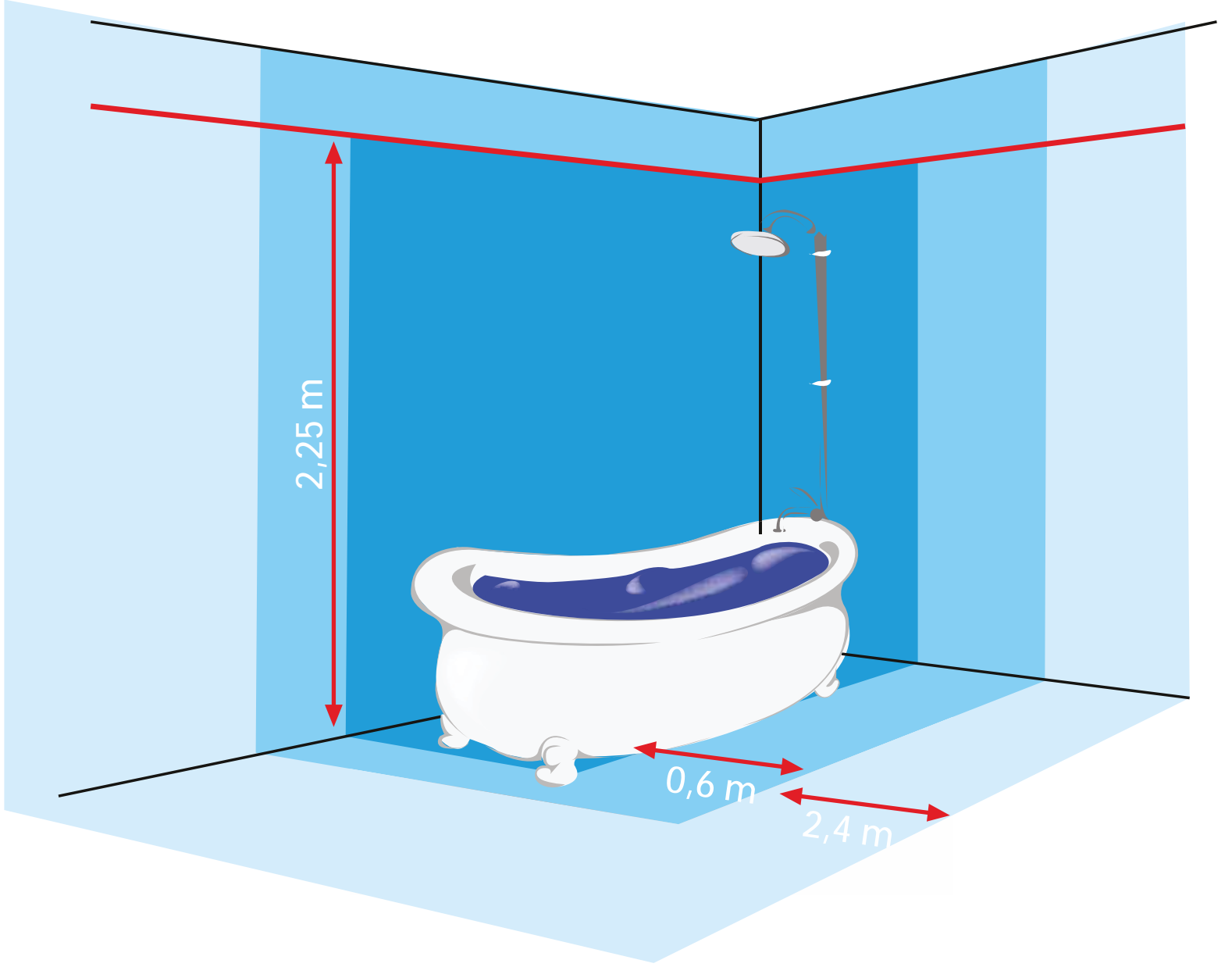

BÖLGE 0 IP 67
ZONE 0 12V

BÖLGE 1 IP 44
ZONE 1 12V

BÖLGE 2 IP 44
ZONE 2

BÖLGE 3 IP 21
ZONE 3

YERE GÖMME ARMATÜRLER İÇİN MONTAJ ŞEMASI

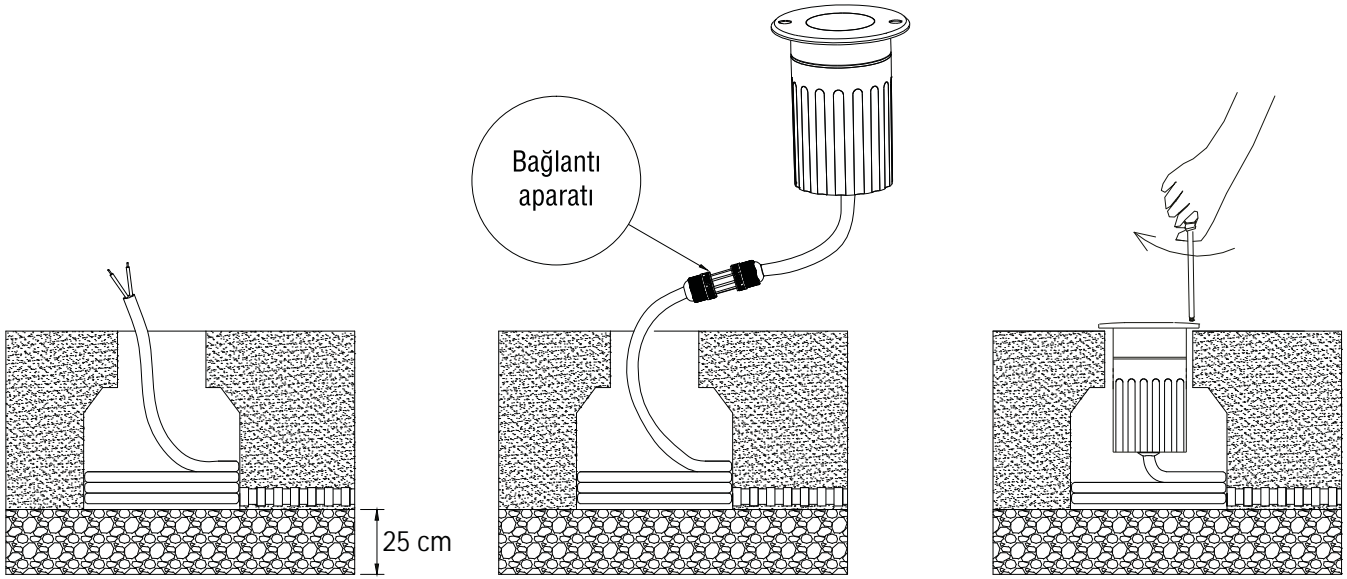

Kabloyu montaj aparatından geçirip, aparatı üst kısmı yer yüzeyiyle aynı hizada olacak şekilde yerleştirin.

Gerektiğinde armatürü çıkarıp bakım yapmanıza izin verecek uzunlukta kabloyu armatüre bağlayın.

Armatürü montaj aparatına yerleştirin

Not: Ürünün altında en az 25 cm çakıl vb. bulunmalıdır

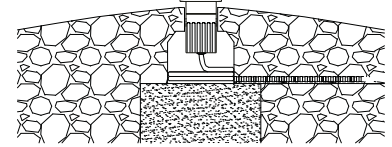
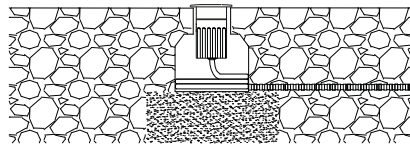
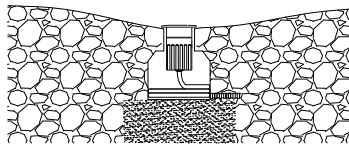

ŞERİT LED BAĞLANTI ŞEMASI

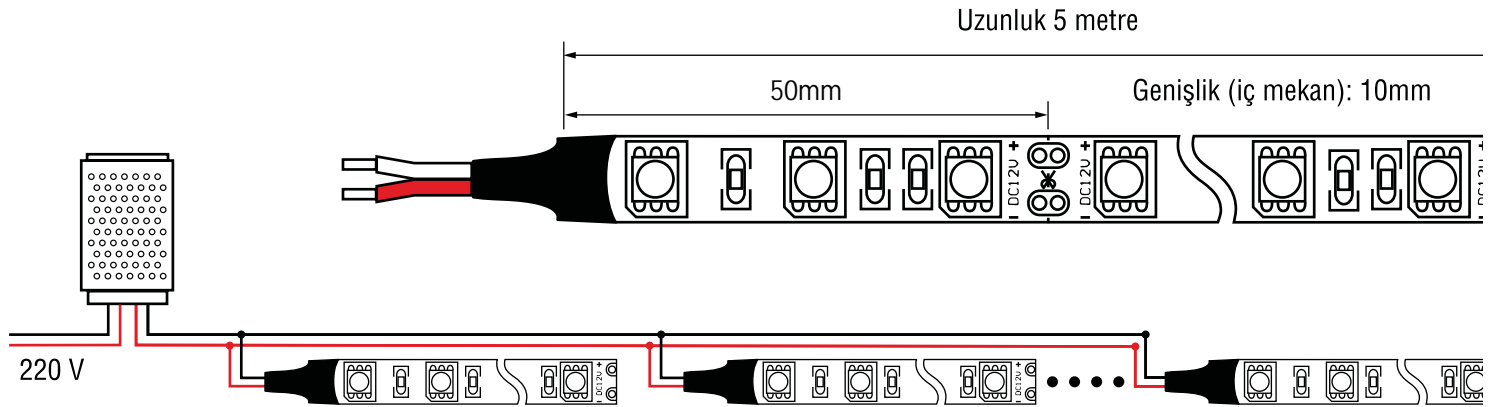

- Şerit LED'lere her 5 metrede bir yeniden güç bağlantısı yapılmalıdır.
- 3M bantını çıkarıp şeridi metal bir yüzeye yapıştırın, aksi halde ısınan LED'ler ışık kaybeder ve ömürleri kısılır.

JUPITER ürünlerini önceden haber vermeksizin değiştirme hakkını saklı tutar.
Bu katalogta kullanılan fotoğraflar baskı tekniğinden dolayı gerçek renklerini yansıtmayabilir.
Katalogta kullanılan tüm fotoğrafların yayın hakları firmamıza aittir. İzinsiz olarak kullanılamaz.

Grafik düzenleme: Ali Ergün Tasarım Reklamcılık
info@aliergun.com

Doğru ışık her şeydir!



- Philips Essential LED Lamba, **Tasarruf Ondan Sorulur!**
- **Daha az ödeyerek**, daha uzun ömürlü LED lamba alın
- Enerji tasarrufu kategorisinde **A+**
- Uzun kullanım ömrü; **10.000 saat**
- **2 yıl** Philips Garantisi



Essential 8W LED Ampul
Sarı/Beyaz ışık
E27

A+ ve A++
sınıfları eklendi.

F ve G sınıfları kaldırıldı.
En düşük enerji tüketimi
E sınıfı oldu.

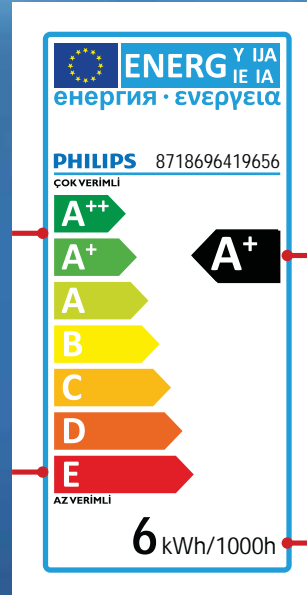

A+ sembolü
lambanın çok verimli
olduğunu anlatıyor.

Kilovattsaat (kWh)
cinsinden enerji
tüketimi enerji etiketi
üzerinde belirtiliyor.

www.lighting.philips.com.tr
Tüketici Danışma Hattı: 0850 390 19 22

f /philips.aydinlatma
t /PhilipsLightTR
i /philipsaydinlatma



PHILIPS